

# 低互调转接器



## 端口代号

端口	代号
7/16	34
N	65

## 命名规则

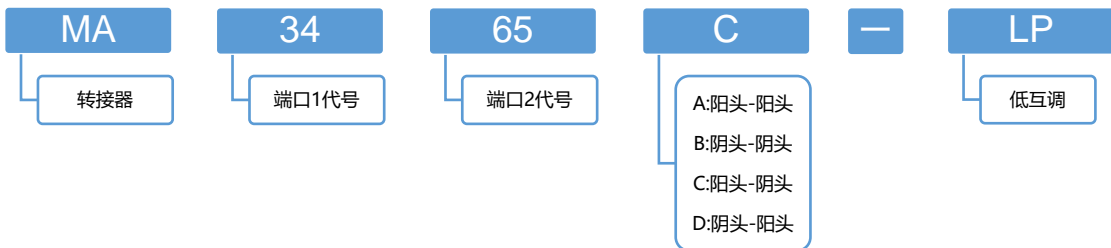

# 7/16-7/16

## 主要性能指标

特性阻抗	50Ω
频率范围	DC~7.5GHz
耐久性	>500次
温度范围	-45°C ~ +125°C

## 材料/表面处理

外导体	黄铜 镀三元合金
内导体	镀青铜 镀银
绝缘体	PTFE
螺帽	黄铜 镀镍

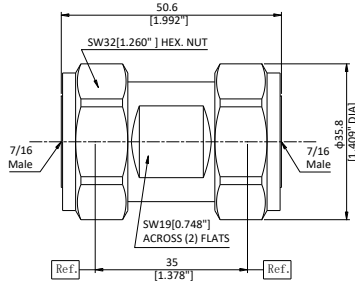

7/16 (m) to 7/16 (m)	
型号	MA3434A-LP
驻波	1.15:1 (max.)
三阶互调	≤-165dBc@1800MHz (2*43dBm)

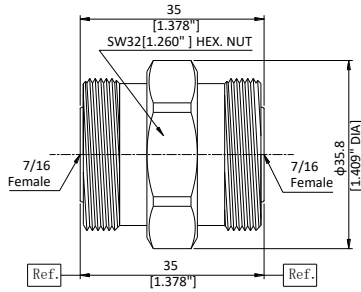

7/16 (f) to 7/16 (f)	
型号	MA3434B-LP
驻波	1.15:1 (max.)
三阶互调	≤-165dBc@1800MHz (2*43dBm)

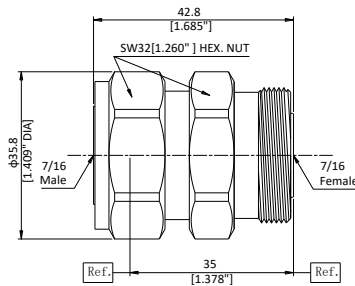

7/16 (m) to 7/16 (f)	
型号	MA3434C-LP
驻波	1.15:1 (max.)
三阶互调	≤-165dBc@1800MHz (2*43dBm)

# 7/16-Type N

## 主要性能指标

特性阻抗	50Ω
频率范围	DC~7.5GHz
耐久性	>500次
温度范围	-45°C ~ +125°C

## 材料/表面处理

外导体	黄铜 镀三元合金
内导体	镀青铜 镀银
绝缘体	PTFE
螺帽	黄铜 镀镍

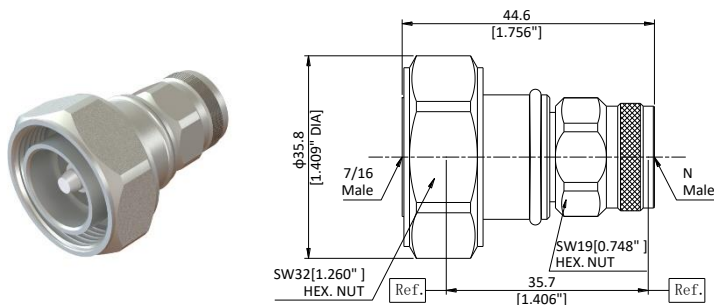

7/16 (m) to Type N (m)	
型号	MA3465A-LP
驻波	1.15:1 (max.)
三阶互调	≤-165dBc@1800MHz (2*43dBm)

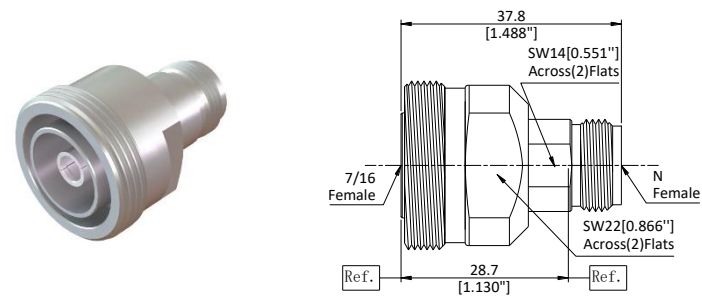

7/16 (f) to Type N (f)	
型号	MA3465B-LP
驻波	1.15:1 (max.)
三阶互调	≤-165dBc@1800MHz (2*43dBm)

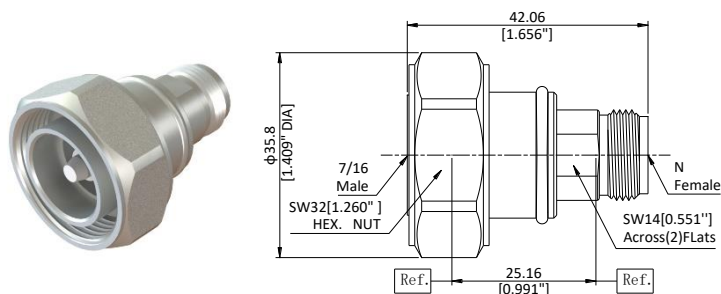

7/16 (m) to Type N (f)	
型号	MA3465C-LP
驻波	1.15:1 (max.)
三阶互调	≤-165dBc@1800MHz (2*43dBm)

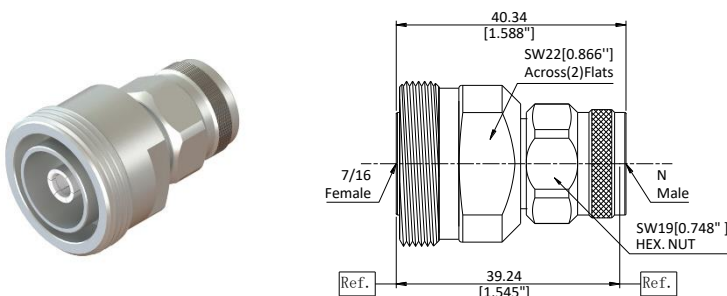

7/16 (f) to Type N (m)	
型号	MA3465D-LP
驻波	1.15:1 (max.)
三阶互调	≤-165dBc@1800MHz (2*43dBm)