

# SPECIFICATION

(产品规格书)

陶瓷 5060 4IN1 LED

( 30W )

<b>Customer</b>	_____
<b>Part NO.</b>	JXT-G6AFDPx
<b>Spec. NO.</b>	JX-SPEC-4IN1-0030
<b>Version NO.</b>	B0
<b>Description</b>	30W 5060 4IN1 Ceramic-LED
<b>Created Date</b>	2021.09.02

-----

<b>CUSTOMER APPROVED</b> (客户确认)		

-----

<b>R&amp;D DEPARTMENT</b> (开发部)		
<b>APPROVED</b> (核准)	<b>CHECKED</b> (审核)	<b>PREPARED</b> (制定)
		邹清清

-----

# 广州晶鑫光电科技有限公司

GUANGZHOU JINGXIN OPTOELECTRONICS TECH CO.,LTD

Part No.	JXT-G6AFDPx	Spec. No.	JX-SPEC-4IN1-0030	Version	B0
----------	-------------	-----------	-------------------	---------	----

## Product Feature (产品特点)

Emitting Color (发光颜色)		Lens (透镜)	Product Description (产品描述)	Input & Output (输入输出)
LED Chip (LED 芯片)	LED (product) (LED 产品)			
Red (红色)	Red (红色)	Water Clear, Flat , Glass (无色透明, 平面, 玻璃)	High Thermal Conductivity Ceramics (高导热陶瓷)	Color Controlled by Circuit (不同接口控制不同光色)
Green (绿色)	Green (绿色)			
Blue (蓝色)	Blue (蓝色)			
Blue (蓝色)	White (白色)			

## Absolute Maximum Rating(At TA=25°C) (极限参数)

Parameter (参数)	Symbol (符号)	Ratings (数值)	Units (单位)
Power Dissipation (功率)	P <sub>D</sub>	30	W
Continuous Forward Current (正向输入电流)	I <sub>F-R</sub>	10...1800	mA
Continuous Forward Current (正向输入电流)	I <sub>F-B/G/C</sub>	10...2500	mA
LED Junction Temperature (结点温度)	T <sub>J</sub>	125	°C
Reverse Voltage (反向电压)	V <sub>R</sub>	5	V
Operating Temperature Range (工作温度)	T <sub>OPR</sub>	-30°C To +85°C	
Storage Condition(储存)	TA & RH	包装未破 25±5°C & 30-65%一年	
ESD Sensitivity (抗静电能力)	ESD	2000V HBM	

**Notes:** \*1, Tolerance  $\Theta$ :10%, ( $\Theta$ 公差为 10%)

\*2, 1/10 Duty Cycle 0.1ms Pulse Width.(脉冲宽度 0.1ms, 占空比 1/10)

# 广州晶鑫光电科技有限公司

## GUANGZHOU JINGXIN OPTOELECTRONICS TECH CO.,LTD

<b>Part No.</b>	JXT-G6AFDPx	<b>Spec. No.</b>	JX-SPEC-4IN1-0030	<b>Version</b>	B0
-----------------	-------------	------------------	-------------------	----------------	----

### ■ Electrical/Optical Characteristics (At Ta=25°C) (光电参数)

Parameter/unit (参数/单位)	Symbol (符号)		Measured Value (测量值) @I <sub>F</sub> =1000mA			Tolerance (公差)
			Min. (最小值)	Typ. (典型值)	Max. (最大值)	
Luminous Flux/lm (光通量/流明)	Φ-R		---	65	80.6	10%
	Φ-G		---	190	220	
	Φ-B		---	43	50	
	Φ-C	Ra>70	---	240	260	
Forward Voltage/V (正向压降/伏)	V <sub>f</sub> -R		1.8	2.2	2.8	0.1V
	V <sub>f</sub> -G		2.8	3.0	3.8	
	V <sub>f</sub> -B		2.8	3.0	3.8	
	V <sub>f</sub> -C		2.8	3.1	3.8	
Dominant Wavelength/nm Color Temperature/K (主波长/纳米色温/开)	Wd-R		615	625	635	1nm
	Wd-G		515	527.5	535	
	Wd-B		450	455	460	
	T <sub>c</sub> -C		5000	6700	10000	10%

<b>Part No.</b>	JXT-G6AFDPx	<b>Spec. No.</b>	JX-SPEC-4IN1-0030	<b>Version</b>	B0
-----------------	-------------	------------------	-------------------	----------------	----

■ **Forward Current VS Relative Luminous (At Ta=25°C, 电流相对光通量曲线)**

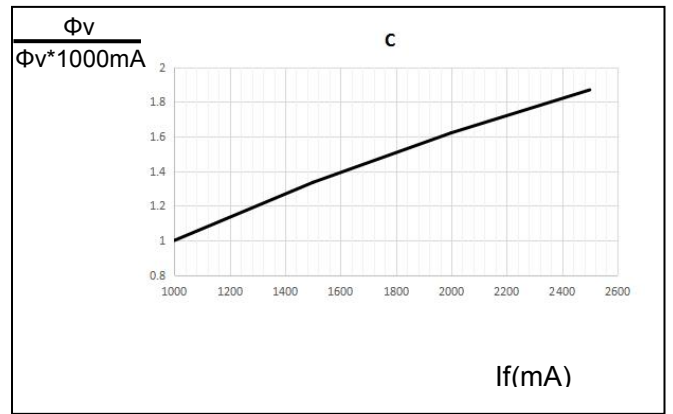
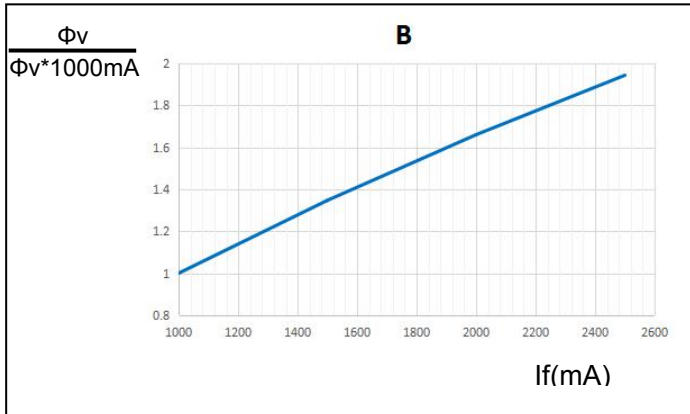
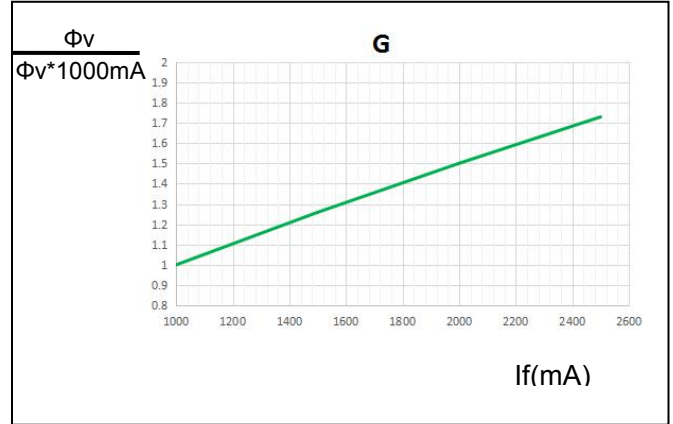
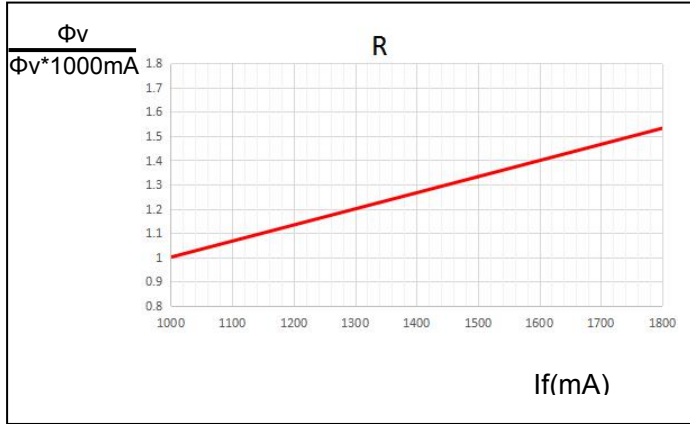

<b>Part No.</b>	JXT-G6AFDPx	<b>Spec. No.</b>	JX-SPEC-4IN1-0030	<b>Version</b>	B0
-----------------	-------------	------------------	-------------------	----------------	----

### ■ Current-Voltage Curves (At Ta=25°C) (电流电压曲线)

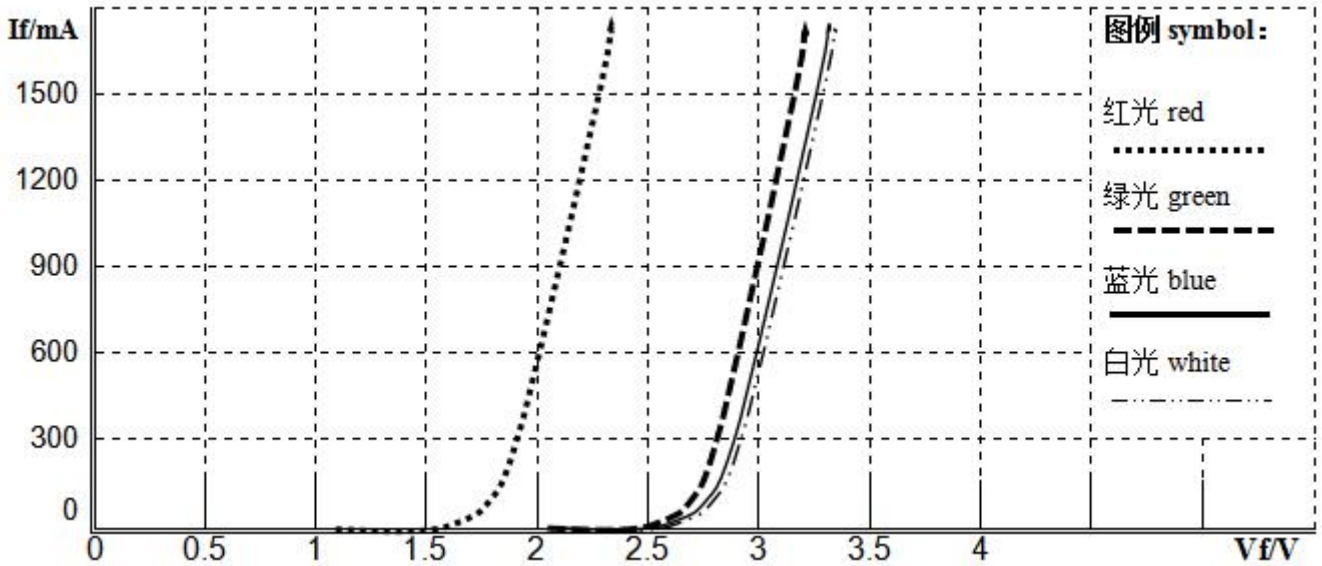

### ■ Spectrum Distribution (At Ta=25°C) (光谱分布)

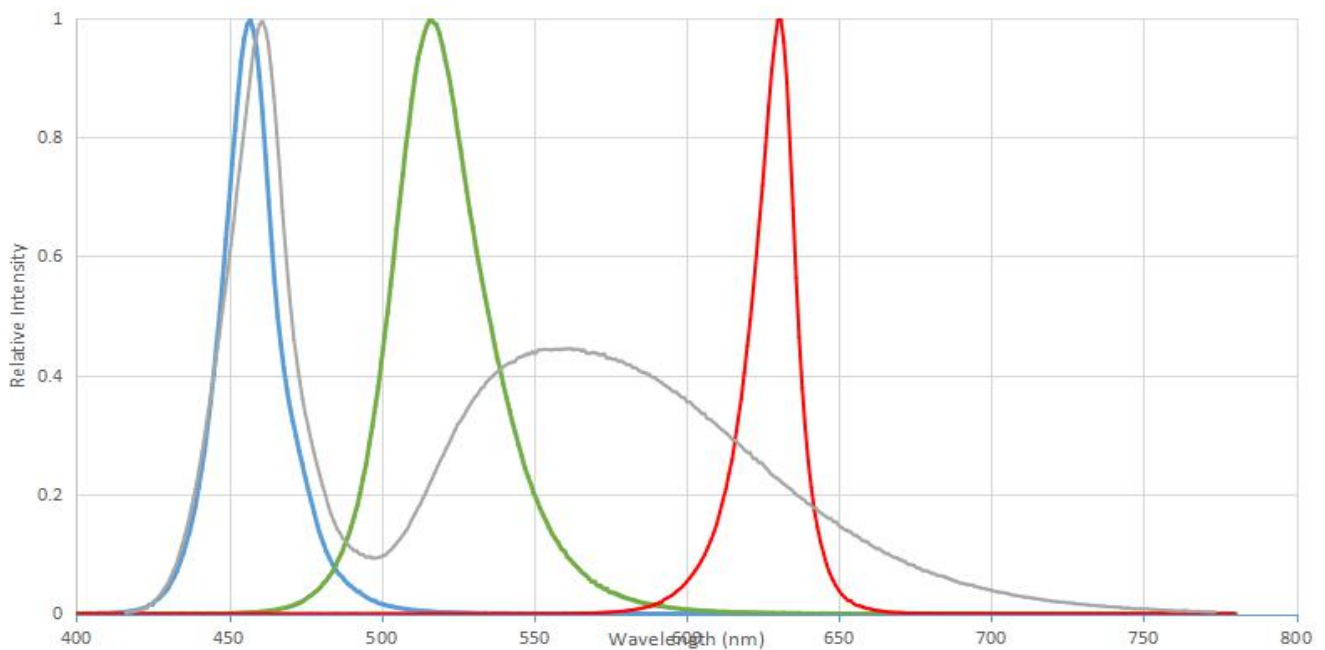

# 广州晶鑫光电科技有限公司

## GUANGZHOU JINGXIN OPTOELECTRONICS TECH CO.,LTD

<b>Part No.</b>	JXT-G6AFDPx	<b>Spec. No.</b>	JX-SPEC-4IN1-0030	<b>Version</b>	B0
-----------------	-------------	------------------	-------------------	----------------	----

### ■ Radiation Pattern (辐射分布)

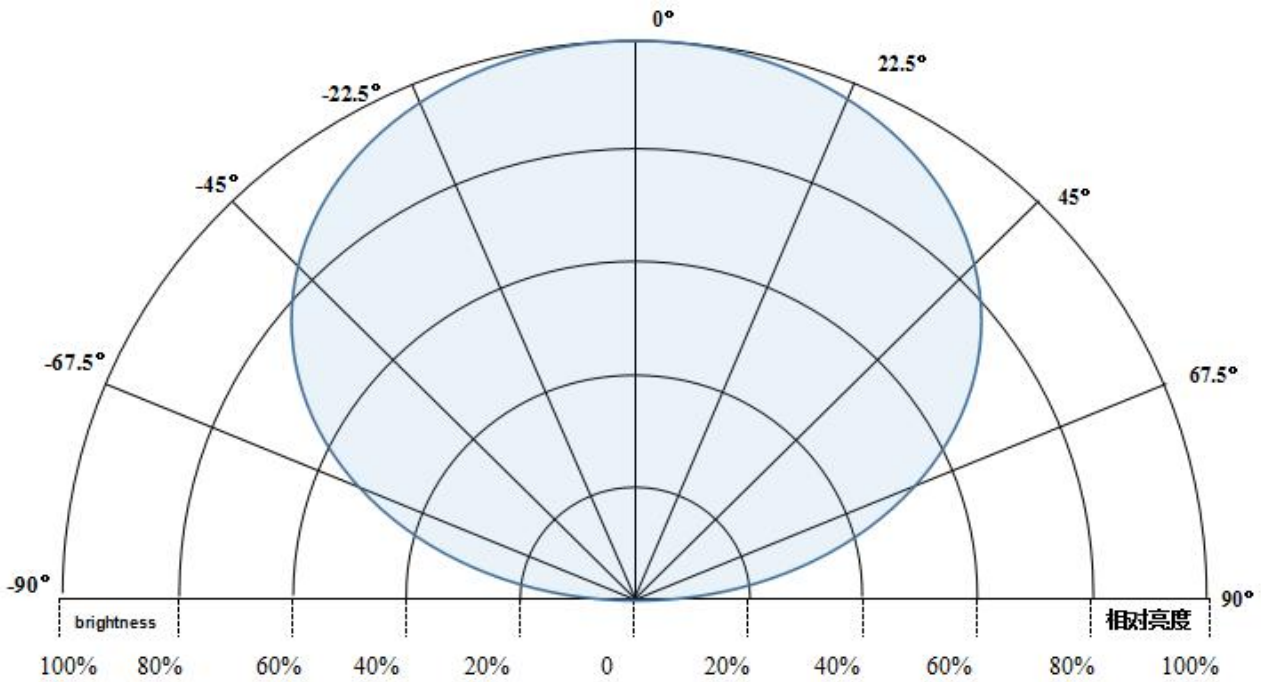

**Notes:** Tolerance  $\Theta$ :10%, ( $\Theta$ 公差为 10%)

### ■ Current-Temperature Curves (最大工作电流与工作环境温度曲线)

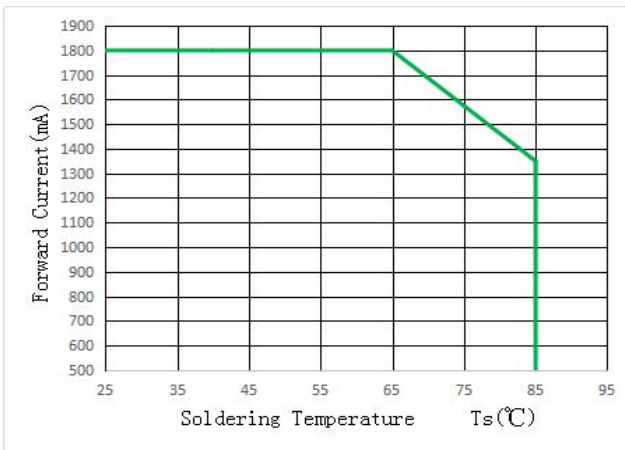

**R**

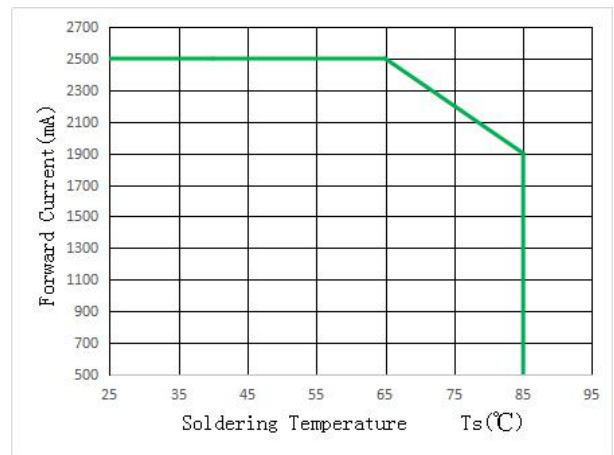

**B/G/C**

注：标绘线表示 LED 的最高工作条件。工作条件即 LED 驱动电源的电流和 LED 表面温度都必须低于这条线。在上图中的示例图中，只要表面温度不超过 65 °C，LED 就可以在光源允许的最大电流下工作。当表面温度超过 65 °C 时，LED 必须以较低的驱动电源电流水平，即图上标绘线下灰色区域中的驱动电源电流水平和表面温度工作。

<b>Part No.</b>	JXT-G6AFDPx	<b>Spec. No.</b>	JX-SPEC-4IN1-0030	<b>Version</b>	B0
-----------------	-------------	------------------	-------------------	----------------	----

### Package Dimensions & Product Picture (封装尺寸与产品图)

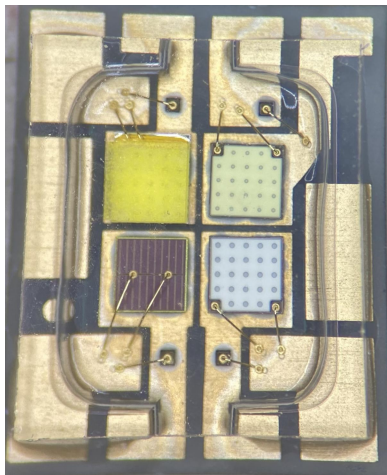
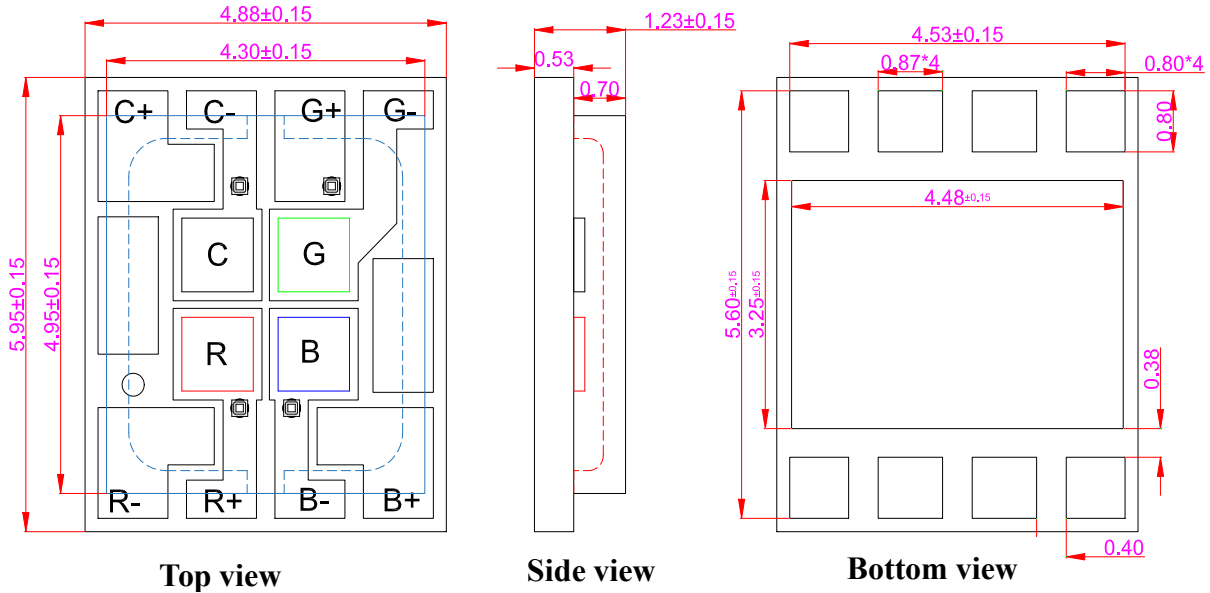

Picture of real products

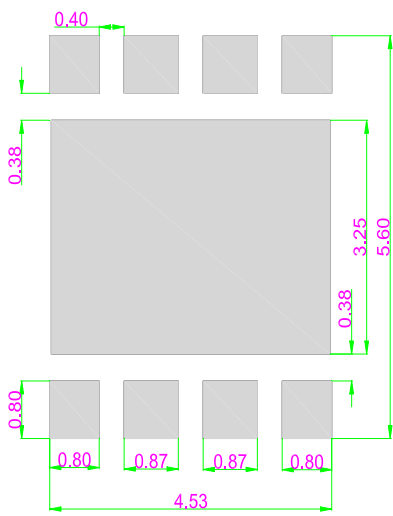

Recommended PCB Solder Pad

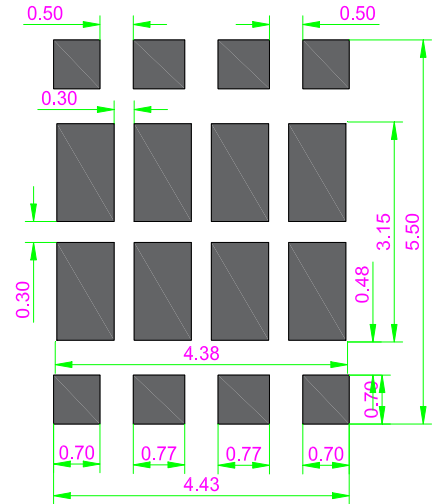

Recommended Stencil Pattern

**Notes:** 1, All dimensions are in millimeters. (所有尺寸以毫米为单位)

# 广州晶鑫光电科技有限公司

GUANGZHOU JINGXIN OPTOELECTRONICS TECH CO.,LTD

Part No.	JXT-G6AFDPx	Spec. No.	JX-SPEC-4IN1-0030	Version	B0
----------	-------------	-----------	-------------------	---------	----

## ■ Reel package ( 1000 pcs/reel) 卷轴包装 (1000 pcs/卷)

D A T A	12.00	5.40	6.40	1.60	0.00	1.75	5.50	8.00	4.00	2.00	1.50	1.50	0.30
	+0.30 -0.30	+0.10 -0.10	+0.10 -0.10	+0.10 -0.10	+0.10 -0.10	+0.10 -0.10	+0.10 -0.10	+0.10 -0.10	+0.10 -0.10	+0.10 -0.10	+0.10 -0.00	+0.10 -0.00	+0.05 -0.05
	W	A0	B0	K0	K1	E	F	P	P0	P2	D0	D1	T

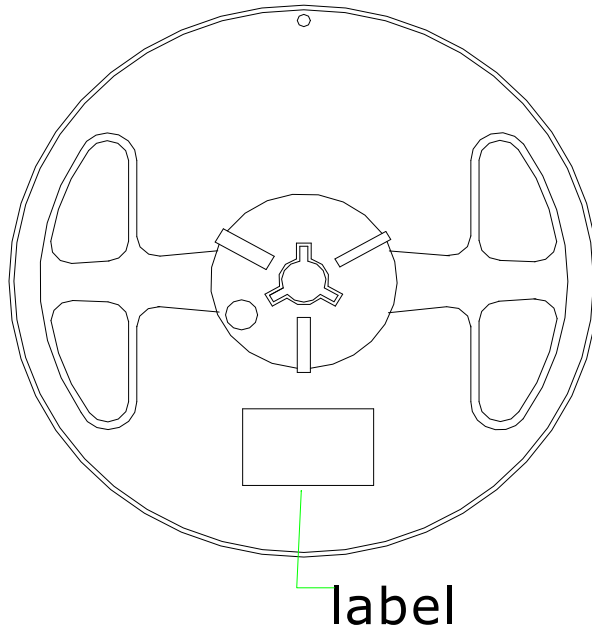
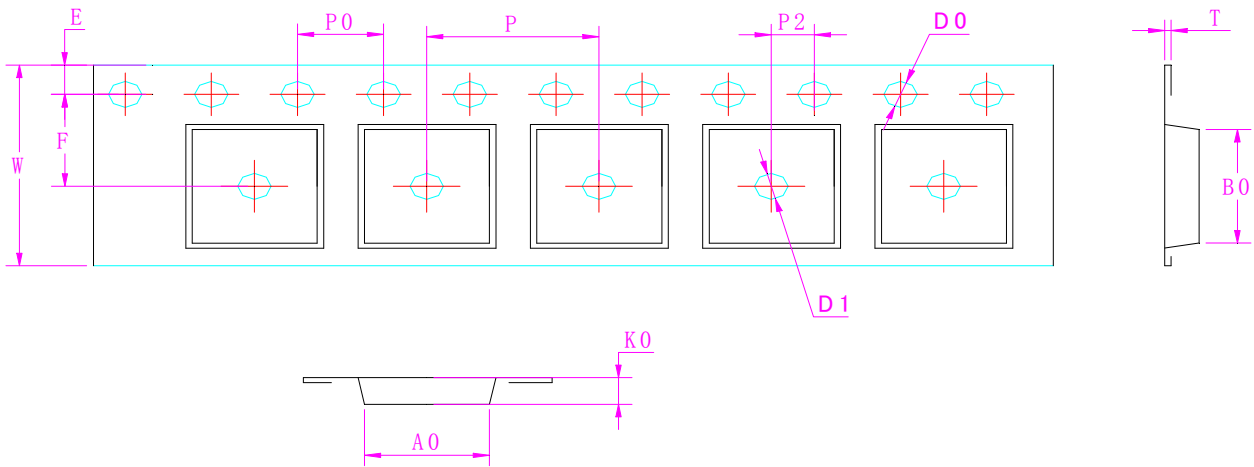



# 广州晶鑫光电科技有限公司

## GUANGZHOU JINGXIN OPTOELECTRONICS TECH CO.,LTD

<b>Part No.</b>	JXT-G6AFDPx	<b>Spec. No.</b>	JX-SPEC-4IN1-0030	<b>Version</b>	B0
-----------------	-------------	------------------	-------------------	----------------	----

### Reflow Profile (回流焊设定)

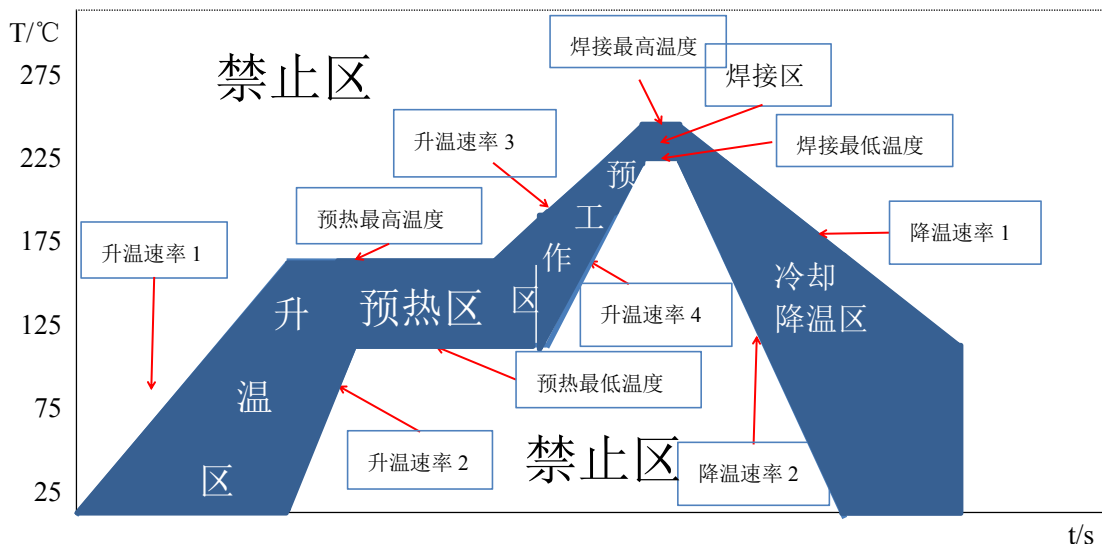

Parameters of Reflow Profile (回流焊参数设定表) :

升温区	升温速率		升温时间	
	$\Delta T/s\text{-min}$	$\Delta T/s\text{-max}$	$\Delta t\text{-min}$	$\Delta t\text{-max}$
	+3°C/s	+5°C/s	20s	60s
预热区	预热温度		预热时间	
	$T_{\text{预-min}}$	$T_{\text{预-max}}$	$t_{\text{预-min}}$	$t_{\text{预-max}}$
	125°C	175°C	60s	120s
预工作区	升温速率		升温时间	
	$\Delta T/s\text{-min}$	$\Delta T/s\text{-max}$	$t_{\text{预-min}}$	$t_{\text{预-max}}$
	+1°C/s	+3°C/s	60s	120s
焊接区 /工作区	焊接温度		焊接时间	
	$T_{\text{焊-min}}$	$T_{\text{焊-max}}$	$t_{\text{焊-min}}$	$t_{\text{焊-max}}$
	以客户需求为准	250°C	5s	10s
冷却 降温区	冷却速率		冷却时间	
	$\Delta T/s\text{-min}$	$\Delta T/s\text{-max}$	$\Delta t\text{-min}$	$\Delta t\text{-max}$
	-6°C/s	-3°C/s	35s	80s
整个回流焊 工艺时间	最短时间		最长时间	
	3 分钟 (180 秒)		7 分钟 (420 秒)	

Notice: 以上仅代表我司验证可行的方案, 不保证一定适合客户端生产需求。

**广州晶鑫光电科技有限公司**  
**GUANGZHOU JINGXIN OPTOELECTRONICS TECH CO.,LTD**

<b>Part No.</b>	<b>JXT-G6AFDPx</b>	<b>Spec. No.</b>	<b>JX-SPEC-4IN1-0030</b>	<b>Version</b>	<b>B0</b>
-----------------	--------------------	------------------	--------------------------	----------------	-----------

**Use the matters needing attention(使用注意事项 )**

**1、储存(storage)：**

为避免受潮的影响，我司建议产品在未开包装前储存条件为 10-30℃，相对湿度小于 60%；已开包装的 LED 光源请在 24 小时 内使用安装完毕，如未用完之产品，请进行除湿并抽真空后密封保存。开封超过一周或湿度卡发生变化时，请务必进行除湿，除湿条件：60℃±5℃，12 小时；产品密封保存有效使用期为一年。

To avoid moisture, we recommend storage conditions for the unopened LED +10 ~ +30 °C, relative humidity <60%; LED should be used within 24Hrs of opening the package, Please make sure to dehumidify and vacuum packing on / unused LED.Be sure to dehumidify the card if it has been open for more than one week or the humidity card changes. Dehumidifying condition: +60 ° C ± 5 ° C, 12Hrs.

Effective age for the sealed led is one year.

**2、组装注意事项(the assembly notes)：**

焊接条件：此产品必须使用回流焊接的作业方式,回流曲线最高温度不可超过 250℃.作业或存放过程中不可有 100g 以上的外力或尖锐物体作用于透镜表面（如压力，摩擦等外力以及钳子镊子等工具），以免造成元件损伤,不允许在变形的 pcb 上焊接

如果超出此使用条件，晶鑫光电将不能保证产品的稳定性，如需使用超出的操作条件，请务必进行风险评估。

Soldering Conditions：This product must be used reflow soldering practices, the maximum temperature of reflow should not exceed 250°C.Please make sure when soldering, there is no external force on the soldering surface (such as pressure, friction or sharp metal nails, etc.), to avoid gold wire deformation or damage and other abnormalities, Weld on anamorphic pcb is not allowed.

If beyond recommended conditions, we cannot guarantee the LED stability, please evaluate the risk assessment first.

**3、防静电措施(anti-Static Measures)：**

请采取足够的措施来防止静电产生，比如带静电环或防静电手指套等；每个制造工序关于产品（工厂、设备、机器、载波机和运输单位）应当连接地面，避免产品电气带电。

Please take adequate measures to prevent electrostatic generation, such as wearing electrostatic ring or anti-static fingerstall etc; any relative products like plant equipment, machinery, carrier and transportation units shall be connected to discharging unit/ ground. After assembly, please make sure to discharge Static Electricity with proper ESD equipment.

**4、温度控制(temperature Control)：**

保证散热前提条件为：TS 点（负极焊盘）为 65 摄氏度以下，在此温度以下，散热符合产品寿命要求；为确保在组装时降低接触热阻，请注意在组装过程中，散热片采用良好品质的导热膏涂布均匀且分布面积合理，不可出现太少或高低不平等现象。

Recommended temperature conditions for enhanced product life: TS (Cathode Point) is <65°C . During assembly, please ensure that a good quality thermal paste is applied and distributed evenly over the surface. While using thermal pad (Heat Sink), make sure LED is firmly tightened and there is no gap between surfaces.

地址：广州花都新华工业区毕村北路 12 号

WEB: [www.jxgdgz.com](http://www.jxgdgz.com)

TEL: 020-36133380

Add: No.12 the North Road of Bi Village Xinhua Industrial Zone Huadu District Guangzhou City Guangdong Province . China

# 广州晶鑫光电科技有限公司

GUANGZHOU JINGXIN OPTOELECTRONICS TECH CO.,LTD

<b>Part No.</b>	JXT-G6AFDPx	<b>Spec. No.</b>	JX-SPEC-4IN1-0030	<b>Version</b>	B0
-----------------	-------------	------------------	-------------------	----------------	----

## 5、驱动控制(drive control)：

本产品需使用恒流源进行驱动，如需使用恒压源或其他使用条件，请进行使用效果风险评估。

Drive this product at constant current, .Before using a constant voltage source or altered specifications, other than recommended, please consider risk factors.

## 6、其他(other)：

本产品不可在以下条件下使用，如果产品在以下条件下使用，评估其使用效果和风险是有必要的：

- 6.1 直接或间接的打湿或受潮；
- 6.2 被海水损害或侵蚀；
- 6.3 被暴露于腐蚀性气体(如 Cl<sub>2</sub>,H<sub>2</sub>S、NH<sub>3</sub>、SO<sub>x</sub>、NO<sub>x</sub> 等) ；
- 6.4 被暴露于粉尘、液体或油；

Product is not suitable to use in following conditions;

- 6.1 Direct or indirect wet / damp conditions;
- 6.2 in contact with sea water and erosive materials;
- 6.3 Exposed to corrosive gases (e.g., Cl<sub>2</sub>, H<sub>2</sub>S, NH<sub>3</sub>, SO<sub>x</sub>, NO<sub>x</sub>, etc.);
- 6.4 Exposed to dust, liquids or oils;