

90 Series General Purpose AC Drive

English Manual

Material Version: V1.3

Date of Filing: 2022-04-02

Company Standard: Q/913703SSC002-2019

We could supply all-round technology support for clients. The users could contact the nearby agency or customer service center of us, and also could contact the manufacturer directly.

All rights reserved. Any alteration is made without notice.

Content

Chapter 1 Products Introduction	1
1.1 Naming Rule.....	1
1.2 Nameplate.....	2
1.3 Model and Technical Parameters	2
1.4 Technical Specification	3
1.5 Product Outline and Installation Hole Sizes	6
1.6 Selection of Braking Package	8
Chapter 2 Keyboard Operation and Electrical Wiring	10
2.1 Operational Keyboard Instruction.....	10
2.2 Operation Process.....	10
2.3 Operating Keyboard Size and Mounting Dimensions	11
2.4 Disassembly and Installation of Keyboard	12
2.5 Wiring Method and Main Circuit Terminals.....	14
2.6 Control Terminal Diagram and Function Description.....	15
Chapter 3 Parameter Function Description.....	17
Chapter 4 Communication Protocol.....	37
4.1 Communication Allocation	37
4.2 Slave Address	37
4.3 Function Code 03: Present Reading the Variant.....	37
4.4 Function Code 06: Presents the Function Code of Writing Variable	39
Chapter 5 Troubleshooting	41
5.1 Fault Information and Troubleshooting Methods	41
5.2 Common Fault and Handling Methods	44

Chapter 1 Products Introduction



Note

1. Do not connect the input power to the output U, V, W, otherwise the AC drive will be damaged!
2. The braking resistor cannot be connected between the (+) and (-) terminals of the DC bus directly, otherwise it may cause a fire alarm!
3. Do not open the cover after power on, otherwise there is danger of electric shock!
4. If the parameters auto-learning is performed, please pay attention to the danger of injury from the motor rotating, otherwise it may cause an accident!
5. Do not repair and maintain the equipment with power on, otherwise there is danger of electric shock!
6. The drive can be maintained and repaired only after the DC bus voltage is lower than 36V, otherwise the residual charge on the capacitor will cause injury to people!
7. Personnel without professional training are not allowed to repair and maintain the ac drive, otherwise it may cause personal injury or equipment damage!

1.1 Naming Rule

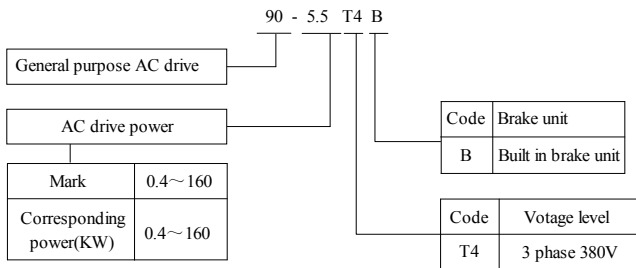

1.2 Nameplate

Specification	MODEL: 90-2.2T4B
Input	INPUT: AC 3PH 380V $\pm 15\%$ 50/60Hz
Output	OUTPUT: AC 3PH 0-380V 0-999HZ 5.0A
Lot Identification	S/N:

1.3 Model and Technical Parameters

Model	Input voltage	Output current (A)	Adopter motor (KW)
90-0.4T4B	3 phase 380V $\pm 15\%$	1.2	0.4
90-0.75T4B		2.5	0.75
90-1.5T4B		3.7	1.5
90-2.2T4B		5.0	2.2
90-3.0T4B		7.0	3.0
90-3.7T4B		9.0	3.7
90-5.5T4B		13.0	5.5
90-7.5T4B		17.0	7.5
90-11T4B		25.0	11
90-15T4B		32.0	15
90-18.5T4B		37.0	18.5
90-22T4B		45.0	22
90-30T4		60.0	30
90-37T4		75.0	37
90-45T4		90.0	45
90-55T4		110.0	55

90-75T4		150.0	75
90-93T4		176.0	93
90-110T4		210.0	110
90-132T4		253.0	132
90-160T4		300.0	160

1.4 Technical Specification

Item		Specification
Input	Rated voltage	T4 series: Three phase 380V±15%
	Frequency	50/60Hz ±5%
Output	Voltage	T4 series: 3 phase 0~380V
	Frequency	0~999Hz
	Overload ability	150% rated current 30s; 180% rated current 1s
Radiating	Cooling type	forced cooling
	Temperature protection	It trips over heat protection when the radiator temperature is higher than 90 degrees
	Fan control	It operates in drive running, and the fan is forced to run when the radiator temperature is higher than 50℃
Control performance	Control mode	Open-loop vector control, V/F control
	Start torque	Open-loop vector control: 0.5Hz 180%, VF control: 0.5Hz 150%
	Speed range	Open-loop vector control: 1:150, VF control: 1:100
	Speed control precision	Open-loop vector control: ±0.2%, VF control: ±0.5%
Function	Operation command channel	Keyboard control, terminal control, communication control
	Start mode	Direct start, DC brake first and restart, Speed tracking restart

	DC brake	Start DC brake , Stop DC brake
	Dynamic braking	Built-in braking unit for AC DRIVE \leq 22KW; no braking function for AC DRIVE >30KW, and without external braking unit connection function
	Frequency source selection	Keyboard digital frequency setting, analog AVI setting, analog ACI setting, keyboard potentiometer setting, multi-speed running setting, PID control setting, communication setting, PLC program running setting, UP/DW terminal increment , Decrement setting
	Main and auxiliary frequency combination setting	Switch to select main frequency setting or auxiliary frequency setting by terminal
	Frequency resolution	Keyboard setting: 0.01Hz, Analogue setting: 0.1%
	Carrier frequency	1Khz~15Khz (The upper limit of the carrier is limited by the model)
	Acceleration and deceleration time	0.1~6000.0s
	Built-in PID	Built-in PID controller, which can be used in process control occasions such as water supply and gas supply. At the same time, it has a sleep wake-up function, which can achieve maximum energy saving.
	Common function	Fault self-recovery, swing frequency operation, jump frequency, UP/DOWN control, automatic voltage regular AVR, over-voltage stall protection, over-current stall protection, etc.
Input and output signal	Analogue input	AVI: 0~10V ACI: 0~20mA
	Analogue output	FM-V: 0~10V FM-I:0~20mA; Analog output terminal, it can be connected to one channel only at the same time.
	Digit input	A total of 28 functions are available selection for S0 to S4.

	Digit output	One open collector output (SP1-24V) One relay output (TA-TC normally open, TA-TB normally closed)
Communication Interface	Communication Protocol	Based on RS485 hardware, it supports standard MODBUS protocol
Display function	Five-digit digital tube display	It can monitor the drive running condition flexibly and conveniently
Protection functions	Various protection functions	Including overvoltage, over-current, overheat, overload, under-voltage, short circuit, protect the ac drive running reliably all-round.
Installation Environment Requirements	Ambient temperature	-10℃~+40℃(ambient temperature is within 40℃~50℃, derating use is required), not allow to contact direct sunlight.
	Humidity	Less than 90% RH, without condensation.
	Application environment	Non-corrosive, flammable, explosive, dust absorbent material, all kinds of lint does not Accumulate.
	Vibration	Less than 0.6G
	Elevation	0~1000m, reduce the rated specification 10% when lift 1000m for each.
	Storage temperature	-20~60℃
Structure	Defend degree	IP20

1.5 Product Outline and Installation Hole Sizes

Product Outline:

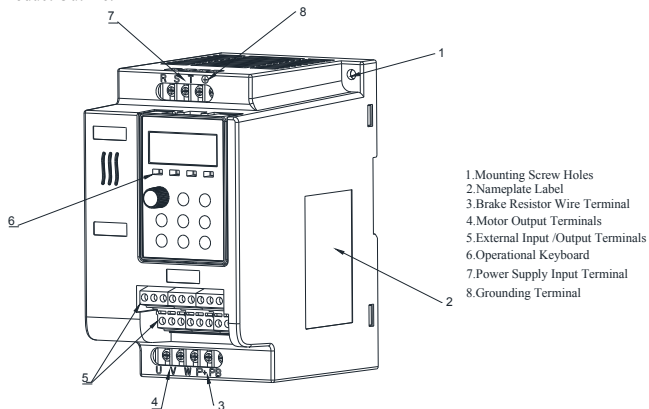

Product size l (mm)

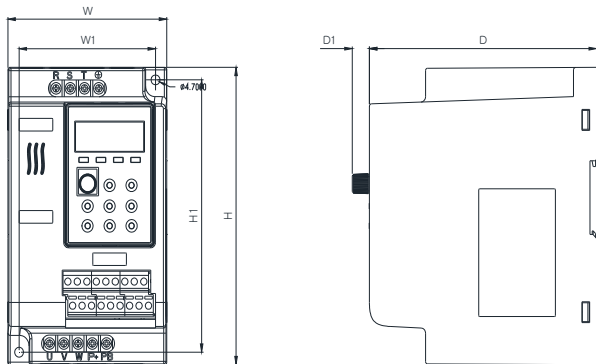

Model	H	W	D	H1	W1	D1	Installing Hole
90-0.4T4B	142	85	121.5	130	73	9.2	φ4.7
90-0.75T4B							
90-1.5T4B							
90-2.2T4B							
90-3.0T4B							
90-3.7T4B	180	95.5	126	168	83	9.2	φ4.7
90-5.5T4B							
90-7.5T4B	220	125	169	205	110	9.2	φ6
90-11T4B							
90-15T4B	290	170	175	275	155	9.2	φ6
90-18.5T4B							
90-22T4B							

Product Appearance 2

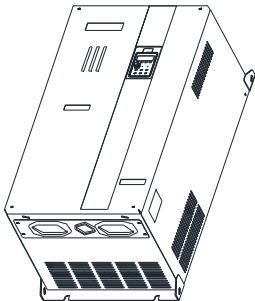

Product size 2

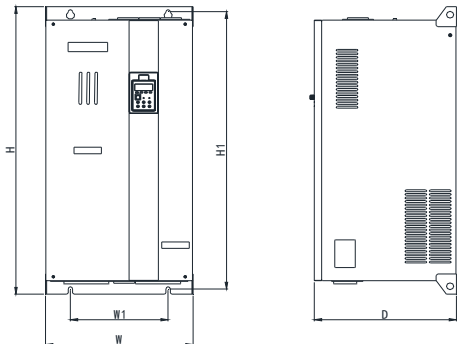

Model	H	W	D	H1	W1	D1	Installing Hole
90-30T4	350	210	210	332	160	9.2	φ7
90-37T4							
90-45T4	400	250	210	382	160	9.2	φ7
90-55T4							
90-75T4	645	300	290	622.5	200	9.2	φ8
90-93T4							
90-110T4							
90-132T4	700	340	297	680	200	9.2	φ10
90-160T4							

1.6 Selection of Braking Package

Model	Braking Resistor Power(W)	Braking resistor value(Ω)
90-0.4T4B	200	≧ 300
90-0.75T4B	200	≧ 300
90-1.5T4B	500	≧ 220

90-2.2T4B	500	≅ 200
90-3.0T4B	500	≅ 200
90-3.7T4B	1000	≅ 130
90-5.5T4B	1000	≅ 100
90-7.5T4B	2000	≅ 65
90-11T4B	2000	≅ 43
90-15T4B	2000	≅ 32
90-18.5T4B	3000	≅ 25
90-22T4B	3000	≅ 22

Chapter 2 Keyboard Operation and Electrical Wiring

2.1 Operational Keyboard Instruction

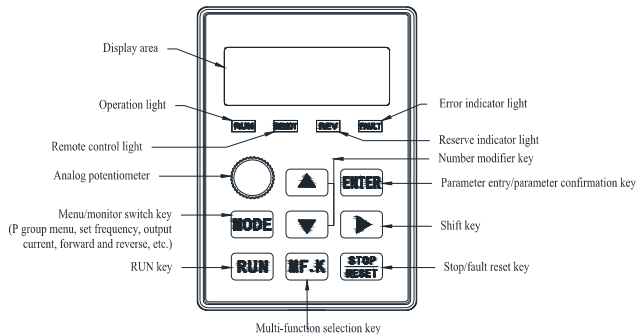

2.2 Operation Process

1. Screen selection

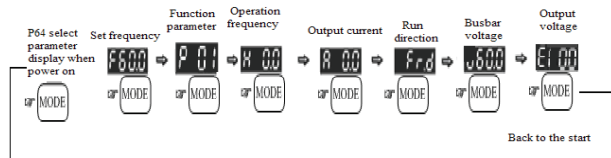

2. Parameter Setting

In the screen selection mode, press Enter to input parameter setting.

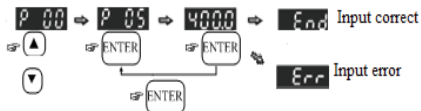

In the parameter mode, press Mode, it can return the screen selection mode.

3. Keyboard digital frequency up and down modification

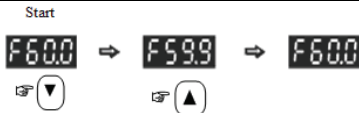

4. Rotation Direction Set

When the operation command source is the digital operation panel, the direction can be modified by the up and down keys.

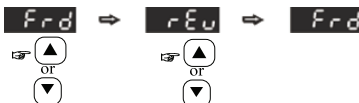

2.3 Operating Keyboard Size and Mounting Dimensions

1. Operating keyboard outline

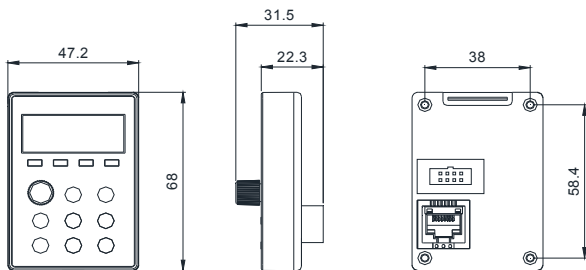

2. Keyboard tray outline size

The keyboard tray extension cable can be selected when it needs to pull the keyboard out to other cabinets or consoles, the tray open size as below:

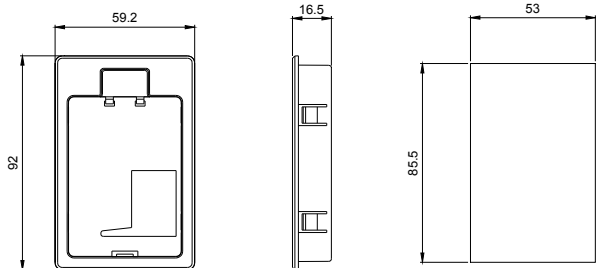

Keyboard tray outline

Keyboard tray opening size

2.4 Disassembly and Installation of Keyboard

1. Disassembly of the keyboard

Refer to the figure below for disassembly of keyboard. Insert a small screwdriver into the buckle slot, press down the screwdriver handle firmly, and push the buckle out of the buckle slot. When installing, insert the lower panel obliquely into the upper panel, align the hook with the groove and press it down vertically to fasten it.

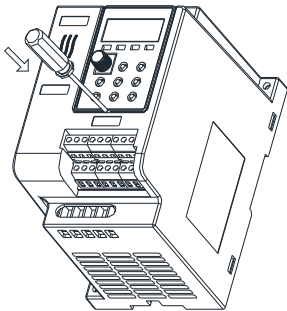

2. Installation of keyboard

Refer to the figure below for the installation of the keyboard, align the operation panel with the bracket, and press the panel inward vertically. When a "click" heard, it indicates that it is snapped in place and the installation is completed.

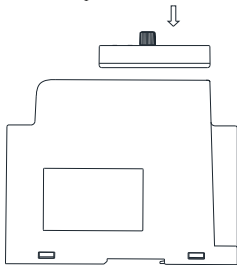

2.5 Wiring Method and Main Circuit Terminals

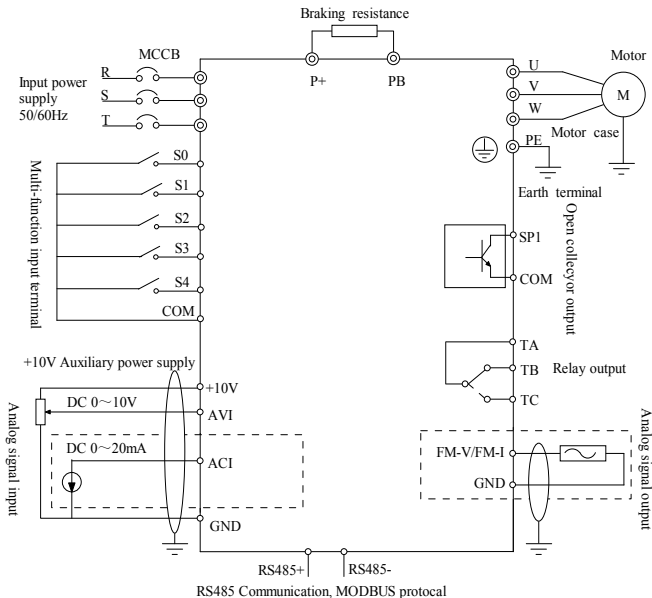

Main Circuit Terminals:

Terminal remark	Name	Description
R、S、T	Power supply input end	AC power connection point
P+、PB	Braking resistor terminal	Connect the brake resistor connection point
U、V、W	Ac drive output terminal	Connect a three-phase motor
⊕	Ground terminal	Ground terminal

2.6 Control Terminal Diagram and Function Description

1. 90 Main control circuit terminals drawing

GND		485+	485-	+10V	FM-V	S0	S1	S2	S3	S4
TA	TB	TC	AVI	ACI	GND	FM-I	SP1	COM	+24V	

2. Function of the control terminals

The main control circuit terminals			
Type	Terminal Symbol	Terminal Name	Function
Power supply	+10V-GND	External connect +10v power supply	Provide +10V power supply for outside, Normally used as working power of the external potentiometer, potentiometer resistance range: 1K Ω ~ 10K Ω Max output current: 10mA
	+24V-COM	External +24V power supply	Provide +24v power supply to outside; generally used as digit input output terminal and external sensor power supply and; the maximum output current: 200A
Analog input	AVI-GND	Voltage Analog input terminal	1. Input voltage range: DC 0V ~ 10V 2. Input resistance: 20K Ω
	ACI-GND	Current Analog input terminal	1. Input range: 0 ~ 20mA 2. Input resistance: 250 Ω
Digital input	S0-COM	Multi-function digital input terminal 0	Function could be set refer to P38-P42, valid when close, and invalid when disconnect
	S1-COM	Multi-function digital input terminal 1	
	S2-COM	Multi-function digital input terminal 2	
	S3-COM	Multi-function digital input terminal 3	
	S4-COM	Multi-function digital input terminal 4	

Analog output	FM-V FM-I	Analog output terminal ,one circuit the same time	FM-V output voltage range: DC 0V~10V; FM-I output current range: DC 0~20mA;
Digital output	SP1-24V	Open collector output	Output voltage range: DC 0V~24V Max output current 50mA
Relay output	TA-TB-TC	Relay output	TA-TB normal closed terminal TA-TC normal open terminal Contact capacity: AC 250V/3A, DC30V/1A
Communication terminal	485- 485+	RS485 hardware circuit	Support standard MODBUS

Chapter 3 Parameter Function Description

“√” indicates the parameter can be modified, no matter the drive runs or stops;

“×” means the parameter cannot be modified while the drive is running;

“○” indicates the parameter can only be read.

Parameter code	Parameter function	Setting range	Factory default	Modification
P00	Main frequency source setting	00: Keyboard digital setting(P14,UP/DN valid) 01: Analog signal 0~10V input(AVI) 02: Analog signal 0~20mA input(ACI) 03: Communication setting (RS-485) 04: Keyboard potentiometer setting	4	×
P01	Run channel source setting	00: Keyboard control 01: External terminal control, STOP key is valid. 02: External terminal control, STOP key is invalid. 03: Communication input control, STOP key is valid 04: Communication input control, STOP key is invalid	0	×
P02	Stop mode	00: Dec to stop 01: Coast to stop	0	√
P03	Highest output frequency	50.0~999.9Hz	50.0	×
P04	Motor rated frequency	10.0 Hz~P03	50.0	×
P05	Motor rated voltage	10V~800V	220 380	×
P06	Intermediate	0.0 Hz~P03	10.0	√

	frequency			
P07	Intermediate voltage	0.1V~510.0V	44.0 76.0	√
P08	The lowest frequency	0.0 Hz~P03	5.0	√
P09	The lowest voltage	0.1V~510.0V	22.0 38.0	√
P10	1st Acceleration time	0.1~999.9s	Model dependent	√
P11	1st Deceleration time	0.1~999.9s	Model dependent	√
P12	2nd Acceleration time	0.1~999.9s For the second acceleration/ deceleration time, it needs to select a terminal from S2~ S5, and set it as selecting acceleration/deceleration time 2. If the terminal is closed, the second acceleration/ deceleration time is selected, and if it disconnects, the first acceleration/deceleration time is selected.	Model dependent	√
P13	2nd Deceleration time	0.1~999.9s	Model dependent	√
P14	Digital frequency setting	0.00~P03	50.00	√
P15	Jog Acc. and Dec. time	0.1~999.9s	10.0	√
P16	Jog run frequency	0.00~P03	6.00	√
P17	1st stage freq. setting	0.00~P03	0.00	√
P18	2nd stage freq. setting	0.00~P03	0.00	√
P19	3rd stage freq. setting	0.00~P03	0.00	√
P20	4th stage freq. setting	0.00~P03	0.00	√
P21	5th stage freq. setting	0.00~P03	0.00	√

P22	6th stage freq. setting	0.00~P03	0.00	√
P23	7th stage freq. setting	0.00~P03	0.00	√
<p>Note: Set multi-speed frequency or PLC running frequency. Multi-stage speed is selected by external input terminals S2~S5. For the relevant parameters of terminal function selection, please refer to P38~P42. Please refer to P78~P87 for the related parameters of PLC operation.</p>				
P24	Reversal function set forbidden	00: Reversal 01: Reversal forbidden	0	×
P25	Overvoltage limit movement level	300.0~999.9V During the deceleration of the drive, when the DC bus voltage exceeds the overvoltage limit protection voltage, the drive stops decelerating and maintaining the present operating frequency, and continues to decelerate after the bus voltage drops.	370.0 715.0	√
P26	VF over current stall protection point	100~200%(Relative to ac drive rated current) During the acceleration and deceleration , when the output current exceeds the over-current stall protection current, the drive stops the acceleration and deceleration process, and continues to accelerate and decelerate after the output current drops.	180	√
P27	Carrier related temperature adjustment enable(when the	0: No enable 1: Enable	1	√

	temperature exceeds 80°C, carrier cut in half.)			
P28	DC braking current set	0~150%(Relative to motor rated current)	50	√
P29	DC braking time setting when start	0.0~10.0s (Start DC braking takes precedence over the start frequency)	0.0	√
P30	DC braking time setting when stop	0.0~20.0s	0.0	√
P31	DC braking starting frequency when stop	0.0~50.0Hz	0.0	√
P32	Forward and reverse dead zone time	0.0~60.0s	0.0	√
P33	VC electric torque digital setting	0.0~250.0%(Relative to motor rated current)	180.0	√
P34	VC generating torque digital setting	0.0~250.0%(Relative to motor rated current)	140.0	√
P35	Reserved			
P36	Output frequency upper limit setting	P37~P03	50.0	√
P37	Output frequency lower limit	0.0Hz~P36	0.0	√
P38	Multi-function input terminal (S0, S1) function selection	00: S0 forward/stop,S1 reverse/Stop 01: S0start/stop,S1 reverse/forward 02: S0、S1、S2 three-wire run control2(S0 forward start,S1 reverse start,S2 disconnect stop) 03: S0、S1、S2three-wire run control1(S0 closed start,S1	0	×

		closed reverse,S2 disconnect stop)		
P39	Multi-function input terminal S2 function selection (when P38 is 2, S2 is fixed as run control terminal)	00: No function 01: Free stop control for all channels 02: UP-DW frequency clear 03: DC braking control	5	×
P40	Multi-function input terminal S3 function selection	04: External fault input 05: Terminal fault reset 06: Multi-step speed 1	6	×
P41	Multi-function input terminal S4 function selection	07: Multi-step speed 2 08: Multi-step speed 3 09: Forward jog	7	×
P42	Reserved (no function)	10: Reversal jog 11: Select Acc. And Dec. time 2 12: Swing frequency forbidden 13: Reserved 14: UP frequency increase by degrees(P140 change rate) 15: DOWN decrease frequency 16: Reserved 17: PLC process reset 18: Counter input 19: Counter reset 20~24: Reserved 25: Parameter locked 26: Reserved 27: Reserved 28: Start 2rd freq. source		

Note: The switch combination for the three terminals of multi-speed 1, multi-speed 2, and multi-speed 3 can be combined into a total of 7 speeds. If combined with the main frequency source and auxiliary frequency source, the function of 9 speeds can be achieved.

The relevant coordination parameters are P17~P23.

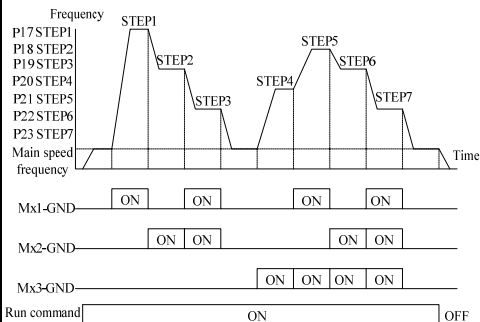

P43	Analog output signal FM setting	0: Output freq.(0~max. output freq.) 1: Output current(0~250% rated current) 2: PID feedback signal(0~10.00V) 3: Output voltage(0~120% ac drive rated voltage) 4: Keyboard potentiometer input signal(0~10.00V)	0	√
P44	Analog output FM gain setting	0~200%	100	√
P45	Multifunction output terminal (SP1) setting	00: Indication in operation 01: Freq. arrival 02: Zero-speed run 03: Freq. level detection (P49、P50)	0	√
P46	Multifunction output relay TA-TB-TC setting	04: External fault 05: Under-voltage stop 06: At least one terminal close 07: Fault indication	0	√

		08: Random freq. arrival (P47、 P48) 09: Freq. arrive upper limit 10: Indication of one phase operation completion 11: Program operation completion indication 12: Freq. arrival lower limit 13: Setting count value arrival(P96) 14: Appoint count value arrival(P97) 15: Reserved 16: S0 terminal closed 17: S1terminal closed 18: S2terminal closed 19: S3terminal closed 20: S4terminal closed 21: Reserved 22: Overtorque indication (P56、 P57)		
P47	Random arrival freq. setting	0.0~999.9Hz	0.00	√
P48	Freq. arrival detection amplitude	0.00~20.00Hz	5.00	√
P49	FDT(Freq. level) setting	0.0~999.0Hz	10.0	√
P50	Frequency FDT hysteresis value	0.0%~100.0%(FDT level)	5.0%	√
P51	Carrier related frequency adjustment enable	0: Carrier not adjusted 1: Carrier is adjusted with operating frequency	0	√
P52	Motor rated current setting	0.10~320.00A	Model dependent	×

P53	Motor no-load current setting	0.10~320.00A	Model dependent	×
P54	Manual operation torque compensation	0.1~50.0% The drive automatically outputs additional voltage during operation to obtain higher torque. Only valid for VF control.	Model dependent	√
P55	Drive rated voltage indication	0.1~3200.0A	Model dependent	
P56	Over torque level	0.0~200.0%(Motor rated torque)	150.0%	√
P57	Over torque judgment time	0.0~10.0s	1.0s	√
P58	Motor overload factor	50.0~130.0%(Motor rated current)	100.0	√
P59	Swing frequency setting mode	0: Relative to center frequency 1: Relative to maximum frequency	0	√
P60	Swing frequency amplitude	0.0~100.0%	0.0	√
P61	Sudden jump frequency amplitude	0.0~50.0%	50.0	√
P62	Swing frequency period	0.1s~999.9s	10.0	√
P63	Swing frequency rise time ratio	0.1~100.0%	50.0%	√
P64	Display Screen selection when start up	00: Show actual operating freq.(H) 01: Motor speed (Ones place has a decimal point for X10) 02: Show output voltage(E) 03: Show main circuit DC	6	√

		voltage(u) 04: Reserved 05: Display count value(c) 06: Display setting freq.(F) 07: Display parameter setting menu(P) 08: Drive temperature (d) 09: Display motor run current(A) 10:Forward/Reverse(Frd/Rev) 11: PID given (U) 12: PID feedback(U)		
P65	Motor speed display ratio	0.01~99.99	1.00	√
P66	Communication freq. setting	0.00~600.00Hz	0.00	√
P67	Forbidden set freq. I	0.0~999.9Hz	0.0	√
P70	Forbidden frequency width setting	0.00~20.00Hz	0.00	√
P71	Carrier freq. setting	0.8~15.0 kHz(The highest carrier depends on the model)	Model dependent	√
P72	Fault automatic reset times	00~10	0	√
P73	The most recent abnormal record	E000: No fault E001: IGBT short circuit protect	0	○
P74	Nearest 2nd time abnormal record	E004: Acceleration over-current E005: Deceleration over-current	0	○
P75	Nearest 3rd time abnormal record	E006: Constant speed over-current E007: Accelerate overvoltage	0	○

		<p>E008: Deceleration overvoltage</p> <p>E009: Constant speed overvoltage</p> <p>E010: Undervoltage in running</p> <p>E011: Motor overload</p> <p>E012: Ac drive overload</p> <p>E013: Communication fault</p> <p>E014: Clear hardware latch timeout</p> <p>E015: The number of automatic resets exceeds the limit</p> <p>E016: IGBT module overheating fault</p> <p>E017: External fault</p> <p>E018: Reserved</p> <p>E019: Current detection fault or output phase loss</p> <p>E020: Motor parameter auto-learning fault</p> <p>E021: EEPROM fault</p> <p>E040: Hardware current limit exceeded</p>		
P76	Parameter lock/reset set	<p>0: No operation</p> <p>1: Parameter initialization(including clearance fault record)</p> <p>2: Only clear fault record</p> <p>4: Clear power consumption</p> <p>7: All parameters can only be read</p> <p>8: Parameter lock (change as</p>	0	×

		0 to unlock)		
P77	Fault automatic reset time interval	0.1~100.0s	5.0	√
P78	PLC running mode selection	01: Stop after one cycle 02: Continuous loop 03: Keep final value after single cycle	1	×
P79	PLC program operation direction selection	0~127(When it is 0, the running direction is controlled by the forward or reverse command; when it is not 0, the running direction is controlled by this parameter); Binary represents: BIT6~BIT0 each bit indicates the direction of the 7th segment to the 1st segment, and the corresponding digit value is 0 for forward rotation, and 1 for reverse rotation; For example P79 = 5 (Binary bit 0000101B), which means that the 3rd and 1st segments are reverse, and the rest are forward	0	×
P80	PLC action selection	0: No action 1: Action	0	×
P81	1st stage run time setting	0~9999s	0	√
P82	2nd stage run time setting	0~9999s	0	√
P83	3rd stage run time setting	0~9999s	0	√

P84	4th stage run time setting	0~9999s	0	√
P85	5th stage run time setting	0~9999s	0	√
P86	6th stage run time setting	0~9999s	0	√
P87	7th stage run time setting	0~9999s	0	√
P88	RS-485 communication address	0~254	1	√
P89	Data transmission speed	0: 4800bps 1: 9600bps 2: 19200bps 3: 38400bps	1	√
P91	Communication transmission overtime detection	0.0: Do not detect communication faulty 0.1~30.0s (If the correct communication data is not received beyond this set time, the ac drive will report a communication error)	0.0	√
P92	Communication data form	0: Modbus ASCII mode, no check <7,N,2> 1: Modbus ASCII mode, no check <7,E,1> 2: Modbus ASCII mode, no check<7,O,1> 3: Modbus RTU mode, no check <8,N,1> 4: Modbus RTU mode, even parity <8,E,1> 5: Modbus RTU mode, odd check<8,O,1>	3	√

		6: Modbus RTU mode, no check <8,N,2> 7: Modbus RTU mode, even parity <8,E,2> 8: Modbus RTU mode, odd parity <8,O,2>		
P93	Start freq.	0.0~10.0Hz	0.0	√
P94	Start freq. duration time	0.0~20.0s	0.0	√
P96	Set count value	0~9999	0	√
P97	Appoint count value	0~9999	0	√

Note: This parameter specifies the counting action of the internal counter, and the clock terminal of the counter is selected by parameter P42. (Only terminal S5 can be selected as the clock input terminal) When the count value of the counter to the external clock reaches the value specified by parameter P96, the corresponding multi-function output terminal outputs a valid width signal equal to the period of the external clock. When the count value of the counter to the external clock reaches the value specified by parameter P97, the corresponding multi-function output terminal outputs a valid signal. When the count exceeds the value specified by parameter P96 and caused the counter is cleared, the output valid signal is cancelled. The clock cycle of the counter is required to be longer than 6ms, and the minimum pulse width is 3ms..

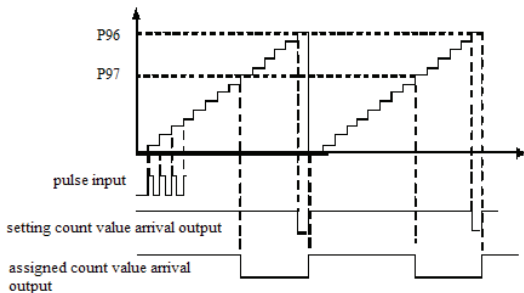

P98	Accumulated power-on time	H		○
P99	Zero frequency or frequency lower than the lower limit frequency selection	0: Run in lower freq. P37 1: Zero frequency standby operation, no output voltage, flashing operation light 2: Zero-speed torque holding (controlled by P54 torque boost)	0	√
P100	Software version	Read only		○
P101	Dead zone compensation gain	0~200	160	√
P102	Automatic stabilization output regulation AVR	0: Invalid 1: All process valid 2: Only deceleration is invalid	0	√
P103	Reserved			
P104	Motor stator resistance	0.001~32.000Ω	Model dependent	×
P105	Control mode	0: V/F control 1: Vector control (Need to be set according to the motor nameplate P107、P108、P04、P05、P52)	0	×
P106	Motor rated slip	0.00~10.0Hz	3.0	×
P107	Motor rated power	0.4~160.0KW	Model dependent	×
P108	Motor rated speed	10~32000 RPM	Model dependent	×
P109	Motor rotor resistance	0.001~32.000Ω	Model dependent	×
P110	Motor leakage inductance	0.01~320.0mH	Model dependent	×
P111	Motor mutual inductance	0.1~3200.0mH	Model dependent	×

P113	Output phase loss protection	0: Invalid 1: Valid	1	√
P114	Reserved			
P115	PID target source setting	0: No PID function 1: Keyboard potentiometer setting 2: AVI(0~10V)setting 3: ACI(0~20mA)setting 4: PID setting address (reference to P125)	0	×
P116	PID feedback source selection	0: AVI(0~10V) 1: Keyboard potentiometer 2: ACI(0~20mA)	0	×
P117	Proportional gain(P)	0~9999(The larger the value, the faster the response and the greater the oscillation)	800	√
P118	Integral gain(KI)	0~9999 (The larger the value, the faster the response and the greater the overshoot)	1500	√
P119	Analog input filter coefficient	0~20(When PID pressure is unstable, increase appropriately; when CNC machine tool requires quick response, decrease appropriately)	6	√
P120	The analog quantity is lower than the lower limit selection	0: Corresponds to 0.0% setting 1: Corresponding to the percentage of the lower limit setting P123 or P133	1	√
P121	AVI Minimum input	0.00~0.20V	0.20	
P122	AVI Minimum input	0.00~10.00V	9.80	√
P123	AVI Minimum input corresponding setting	0.0~100.0%	0.0	√

P124	AVI Maximum input corresponding setting	0.0~100.0%	100.0	√
P125	PID digital setting (can be adjusted by keyboard up and down keys)	0.00~9.99V	0.00	√
P126	PID deviation limit	0.0%~20.0%(The error between PID setting and feedback is less than this setting, PID adjustment is suspended)	0.0	√
P131	ACI Minimum input	0.0~20.0mA	4.0	√
P132	ACI Maximum input	0.0~20.0mA	20.0	√
P133	ACI Minimum input corresponding setting	0.0~100.0%	0.0	√
P134	ACI Maximum input corresponding setting	0.0~100.0%	0.0	√
P135	Sleep delay time	0.0~600.0s, When the ac drive is running, when the running frequency is less than or equal to the P137 sleep frequency, after the P135 delay time, the ac drive enters the sleep state, automatically stops, and the running indicator light flashes.	10.0	√
P136	Awake delay time	0.0~600.0s	2.0	√
P137	Sleep frequency	0.0Hz~999.9Hz 0.0Hz non-dormant	0.0	√
P138	Wake-up deviation percentage	0.0~100.0%, When the current feedback pressure is lower than (pressure setting value *P138), the wake-up timing	80.0	√

		will be performed. When the wake-up timing exceeds the P136 wake-up delay time, the ac drive will exit the sleep state.		
P139	MF.K Shortcut key function setting	0: No function 1: Forward jog 2: Reverse jog	0	√
P140	UP/DW terminal modification rate 0	0.01~50.0Hz/s	2.00	√
P141	Storage digital freq. selection	0: No storage for the keyboard digital frequency when power off 1: Storage for the keyboard digital frequency when power off	1	√
P142	2nd freq. instruction source setting	00: Keyboard digital setting(P14) 01: Analog signal 0~10V input(AVI) 02: Analog signal 0~20mA input(ACI) 03: Communication setting (RS-485) 04: Keyboard potentiometer setting(UP/DN invalid)	0	√
P143	Dynamic braking starting voltage	300.0~900.0V	350.0 660.0	√
P146	Power on terminal start operation lock	0: Operable (operable when the power-on terminal is closed) 1: Non-operable (non-operable when the power-on terminal is closed)	1	√

P150	Current limiting and frequency reduction current level	100.0~250.0% relative to ac drive rated current	165.0	√
P151	Current limiting and frequency reduction maximum drop rate	0~50.00Hz/s	0.00	√
P152	VF Deceleration over excitation gain	0~200 During the deceleration of the ac drive, this parameter can suppress the rise of bus voltage and avoid over-voltage faults. The larger the over excitation gain, the stronger the suppression effect, but it is easy to cause the output current to increase or the speed to fluctuate, which needs to be weighed in the application	0	
P153	VF over current stall gain	0~100 The larger the value, the stronger the ability to suppress over-current. For the load with small inertia, the over-current stall gain should be small, otherwise the dynamic response of the system will slow down. For loads with large inertia, this value should be large, otherwise the suppression effect will not be good, and overcurrent faults may occur.	10	√
P154	VF overvoltage stall	0~100	0	√

	gain	The larger the value, the stronger the ability to suppress overvoltage, but the actual deceleration time will be longer. In the absence of overvoltage, the smaller the gain setting, the better.。		
P155	Oscillation suppression gain	0~100 Only when the motor oscillates significantly, the gain needs to be appropriately increased. The larger the gain, the more obvious the suppression of oscillation	0	√
P156	Communication response delay time	0~1000ms	3	√
P163	The latest fault current	A		○
P164	The latest fault voltage	V		○
P165	The latest fault frequency	Hz		○
P166	Reserved			
P168	Accumulated power consumption display	KW.H		
P200	Running frequency	0.01Hz/0.1Hz		○
P201	Set frequency	0.01Hz/0.1Hz		○
P202	Bus voltage	1V		○
P203	Output voltage	1V		○
P204	Output current	0.1A		○
P205	Output power	0.1KW		○
P207	Input terminal decimal			○
P208	output terminal decimal			○
P209	Analogue AVI input voltage	0.01V		○

P210	Analogue ACI input value	0.1mA		○
P211	IGBT temperature	0.1℃		○
P212	Count value			○
P213	Reserved			○
P214	Motor rotate speed	RPM		○
P215	PID setting	0.00V		○
P216	PID feedback	0.00V		○
P217	Present PLC stage			
P221	FM output voltage	0.01V		
P227	U phase current	0.1A		
P228	V phase current	0.1A		
P229	W phase current	0.1A		
P230	Main setting frequency	0.01Hz/0.1Hz		○
P231	Auxiliary setting frequency	0.01Hz/0.1Hz		○
P232	AC drive overload count			○
P233	Motor overload count			○

Chapter 4 Communication Protocol

4.1 Communication Allocation

Set baud rate and parity bit through P89, P92.

4.2 Slave Address

The address of the ac drive should be set through P88, 0 is broadcast address, slave address could be set to 1~254.

4.3 Function Code 03: Present Reading the Variant

1. Readable parameter address distribution:

Function	Address	Data and meaning
Faulty status	2100H	0: No fault
		1: IGBT Short-circuits protection
		4: Over-current during Acceleration
		5: Over-current during Deceleration
		6: Over-current in constant speed operation
		7: Over-voltage during Acceleration
		8: Over-voltage during Deceleration
		9: Over-voltage in constant speed
		10: DC Bus under-voltage fault
		11: Motor over-load
		12: Ac drive over-load
		16: IGBT module's heatsink overheat
		17: External equipment fault
		19: Current detection circuit has fault or output loss phase
		20: Motor Auto-learning fault
21: EEPROM operation fault		
24: Temperature sensor fault		
40: Hardware current limit exceeded		

AC drive operation status	2101H	BIT5: 0 Standard status, 1 fault status
		BIT11: 0 forward running status, 1 reverse running status
		BIT12: 0 stop, 1 running
Monitoring parameters	2102H	Setting frequency 0.01Hz
	2103H	Output frequency 0.01Hz
	2104H	Output current 0.1A
	2105H	DC bus voltage 0.1V
	2106H	Output voltage 0.1V
	2107H	Multi-speed or PLC present segment
	210BH	Motor rotate speed RPM
	210DH	Temperature of the ac drive 0.1℃
	210EH	PID feedback value 0.01V
	210FH	PID target value 0.01V
	2111H	Analog quantity AVI value 0.1V
	2112H	Analog quantity ACI value 0.1mA
2113H	External terminal	
Function parameter	P00~P162(Corresponding hexadecimal number is 0000H~00A2H)	Read the corresponding function code parameter value

2. Examples of communication frame content

The upper machine read two data from the ac drive, and the two data is setting frequency and output frequency, the address is 2102H, 2103H, and the upper machine should send the data to the ac drive as follows;

Slave address	Function code	Parameter address high byte	Parameter address low byte	Read data high byte	Read data low byte	CRC Parity bit high byte	CRC Parity bit low byte
01	03	21	02	00	02	6F	F7

The setting frequency of the ac drive is 50.00Hz (corresponding 16 system data is 1388H). Bus voltage is 540.0v (corresponding 16 system data is 1518H).The ac drive feedback the

data to upper machine: $n=2$ is the number of variable quantity.

Slave address	Function code	Read data of byte (2*n)	The first data high byte	The first data low byte	The second data high byte	The second data low byte	CRC Parity bit high byte	CRC Parity bit low byte
01	03	04	13	88	13	88	73	CB

4.4 Function Code 06: Presents the Function Code of Writing Variable

1. The address distribution of writing parameter:

Function	Address	Data	Meaning
Communication control command	2000H	BIT0~1	00B: No function
			01B: Stop
			10B: Start
			11B: JOG(jog)start
		BIT2~3	Reserved
		BIT4~5	00B: No function
01B: Forward			
10B: Reverse			
11B: Reverse operation			
BIT6~15	Reserved		
Address of communication setting frequency	2001H	Frequency command 0.01Hz ,both reading and writing are available	
Reset command	2002H	BIT0	Reserved
		BIT1	Reset
Writing function parameter ROM	P00~P162 (Corresponding 16 systems: 0000H~00A2)	Set corresponding function code, and store in ROM, storage after power-off	
Writing function parameter RAM	P00~P162 (Corresponding 16 systems: 8000H~80A2)	Set corresponding function code, and store in RAM, without storage after power-off	

2. Examples of communication frame content

Example 1: Modify the deceleration time of the ac drive to 30.0s through the upper machine, corresponding 16 system data is 012CH, and store this setting when power-off. Dec time F0.11 responds the address of 16 systems is 000BH.

And the upper machine sends the data to the ac drive as follows;

Slave address	Function code	Parameter address high byte	Parameter address low byte	Data high byte	Data low byte	Parity bit high byte	Parity bit low byte
01	06	00	0B	01	2C	F8	45

And the ac drive feedback to the upper machine as follows;

Slave address	Function code	Parameter address high byte	Parameter address low byte	Data high byte	Data low byte	Parity bit high byte	Parity bit low byte
01	06	00	0B	01	2C	F8	45

Example 2 Modify the deceleration time of the ac drive to 30.0s through the upper machine, corresponding 16 system data is 012CH, and not store this setting when power-off. Dec time F0.11 responds the address of 16 systems is 800BH.

And the upper machine sends the data to the ac drive as follows;

Slave address	Function code	Parameter address high byte	Parameter address low byte	Data high byte	Data low byte	Parity bit high byte	Parity bit low byte
01	06	80	0B	01	2C	D1	85

And the ac drive feedback to the upper machine as follows;

Slave address	Function code	Parameter address high byte	Parameter address low byte	Data high byte	Data low byte	Parity bit high byte	Parity bit low byte
01	06	80	0B	01	2C	D1	85

Chapter 5 Troubleshooting

5.1 Fault Information and Troubleshooting Methods

Fault code	Fault categories	Possible reasons of fault	Actions
E004	Over-current during acceleration	Too short Acc time	Prolong the Acc time
		Low AC supply voltage	Check the input power supply
		Drive power capacity is too small	Select a higher power ac drive
E005	Over-current during deceleration	Too short Dec time	Prolong deceleration time
		Low AC supply voltage	Appropriate dynamic braking components
		Drive power capacity is too small	Select a higher power ac drive
E006	Over-current in constant speed operation	Sudden change of load or abnormal	Check the load or reduce the sudden change of load
		Low AC supply voltage	Check the input power supply
		Drive power is too small	Select a higher power ac drive
E007	Over-voltage during acceleration	Abnormal input voltage	Check the input power supply
		The rotating motor re-starts after the drive stops instantly.	Avoid re-start after the drive stops instantly
E008	Over-voltage during deceleration	Too short Dec time	Prolong the Dec time
		Too big load inertia	Use bigger dynamic braking kit
		Abnormal input voltage	Check the AC supply voltage
E009	Over-voltage in constant speed operation	Abnormal change of input voltage	Install input reactor
		Abnormal change of input voltage	Use suitable dynamic braking kit
E010	DC Bus under-voltage	Low AC supply voltage	Check the AC supply voltage

Fault code	Fault categories	Possible reasons of fault	Actions
E011	Motor over-load	Low AC supply voltage	Check the AC supply voltage
		Improper motor's rated current	Re-set motor's rated current
		The motor is blocked or the load sudden increase	Check the load, adjust the value of torque boost
		The drive's and motor's powers don't match	Use suitable motor
E012	AC Drive over-load	Too short Acc time	Prolong the Acc time
		The rotating motor re-start	Avoid re-start after the drive stops instantly
		Low AC supply voltage	Check the AC supply voltage
		Too heavy load	Select a higher power ac drive
E013	Communication fault	The upper machine is not working properly	Check the upper machine connection
		The communication line is abnormal	Check the communication cables
		The communication line is abnormal	Set communication parameters correctly
E014	Clear hardware lock timeout	Control board is abnormal	Seek service
		Hall sensor or hall line is abnormal	Seek service
E015	Number of automatic reset exceeds the limit	External equipment fault or the drive fault	Check the fault record for troubleshooting
E016	Inverter module overheated	Blocked air duct or damaged fan	Drain the air duct or replace the fan
		The ambient temperature is too high	Reduce ambient temperature
		Control board connection or plug-in loose	Check and re-wire

Fault code	Fault categories	Possible reasons of fault	Actions
		The auxiliary power supply is damaged, and the driving voltage is undervoltage	Seek service
		Power IGBT faulty	Seek service
		Control board is abnormal	Seek service
E017	External equipment fault	SI External fault input terminal action	Check the input of the external device
E019	Current detection circuit fault or output phase loss	Wires or connectors of control board are loose	Check the connector and re-wire
		Auxiliary power supply is damaged	Seek service
		Hall sensor is damage	Seek service
		Abnormal amplifying circuit	Seek service
E020	Motor Auto-learning faulty	Motor's and drive's capacity doesn't match each other.	Replace the drive with another model
		Improper settings of motor rated parameters	Set the parameters correctly According to the nameplate
		Large deviations between auto-learning parameters and standard parameters	Make the motor no load, re-identify
		Over time auto-learning	Check motor wiring and parameter settings
E021	EEPROM read and write fault	EEPROM damaged	Seek service
E024	Temperature sensor fault	Temperature sensor disconnection or circuit fault	Power off, and check the ac drive temperature wire loosen or not, seek service

Fault code	Fault categories	Possible reasons of fault	Actions
E040	Hardware current limit exceeds	The load is too heavy or the acceleration time is too short or the motor is blocked	Select a higher power ac drive, increase the acceleration time, and eliminate the motor blockage

5.2 Common Fault and Handling Methods

Phenomena	Possible reasons of fault	Actions
The drive doesn't display after power-on	Drive's input supply is inconsistent with the rated voltage	Check with a multi-meter and troubleshoot the issue.
	3-phase rectifier bridge blasted	Seek service
The MCCB trips after power-on	There is a ground or short circuit between the input power	Troubleshoot the issue
	Rectifier breakdown, power line and motor line connect wrongly	Seek service
The motor is standstill after the drive running	The 3-phase outputs among U, V, and W are unbalance.	Check if damaged or obstructed
	No output voltage	Check whether the motor parameters are set correctly Seek service
The drive display is normal, after power-on, the MCCB of the power trips after operating	Phases shorted between output modules	Seek service
	Short circuit or grounding between motor leads	Troubleshoot the issue
	The distance between the motor and drive is far, Occasionally trips	Install output ac reactor

Guarantee Agreement

Warranty of the company products executes in Accordance with "the quality assurance" in instructions.

1. Warranty period is 12 months from the date of purchasing the product
2. Even within 12 months, maintenance will also be charged in the

following situations:

2.1. Incorrect operation (According to the manual) or the problems are caused by unauthorized repair or transformation.

2.2. The problems are caused by exceeding the requirements of standards specifications to use the drive.

2.3 After purchase, loss is caused by falling damage or improper transportation.

2.4 The devices' aging or failure is caused by bad environment (corrosive gas or liquid).

2.5 Earthquake, fire wind disaster, lightning, abnormal voltage or other Accompanied natural disasters cause the damage.

2.6 Damage is caused during transport (note: the mode of transportation is determined by customers, the company helps to handle the transferring procedures of goods).

2.7 Unauthorized tearing up the product identification (e.g.: Nameplate, etc.); the serial number does not match the warranty card.

2.8 Failing to pay the money According purchase agreement.

2.9 Cannot objective actually describe the installation, wiring, operation, maintenance or other using situation to the company's service units.

Manufacturers: BY CHINA