

WARNING!!

DO NOT LOOK AT SUN THROUGH TELESCOPE. IT WILL CAUSE IRREVERSIBLE DAMAGE TO YOUR EYE.

www.sharpstar-optics.com

English

Instructions for use

Askar V is a newly launched product concerning our customers' needs. It comes out with a big innovation, which means it has not only two objective lenses (60mm and 80mm), but also three accessories (reducer, flattener, and extender). Users can choose and adapt accessories according to their needs in focal lengths.

Description:  
The overall appearance of the Askar V is simple and generous, the color scheme of ivory white and silver makes it cool and elegant, and every detail of the design reflects exquisite craftsmanship and quality. Askar V not only has an elegant appearance and high-quality mechanical design but also has excellent star performance and rich function configuration.

The V60 objective lens and V80 objective lens, both adopt a triplet APO design, two of which are ED glasses, which can effectively eliminate chromatic aberration and increase image clarity. The V60 native focal ratio is f/6, and the focal length is 360mm. The V80 native focal ratio is f/6.25, and the focal length is 500mm. V is equipped with three additional accessories that are adjustable to 60mm or 80mm scales through rotation. The rear end of each

accessory has M48 and M54 adapters with 2" built-in filter thread and the back focus is a standard 55mm. When using the V60 objective lens, you can rotate the accessories to 60 scales to use; when using the V80 objective lens, the accessories should be rotated to 80 scales to adapt to the different aperture sizes of the different objective lenses.

The V reducer can effectively reduce exposure time and expand the field of view to meet more of the shooting requirements. When the reducer is used with V60 objective lens, the focal length is reduced to 270mm, and the focal ratio is increased to f/4.5; when the reducer is used with V80 objective lens, the focal length is reduced to 384mm, and the focal ratio is increased to f/4.8.

The V flattener improves field curvature, edge quality and reduces aberrations. When used with the 60mm objective lens, the focal length remains 360mm and the focal ratio is f/6, while when used with the 80mm objective lens, the focal length changes to 495mm and the focal ratio becomes f/6.18.

V extender, as the highlight of the product set, fully shows our none-stop innovation spirit and fulfills a part of the market vacant. V extender being used with the objective lens at the aperture of 60mm, the focal length is 446mm and the focal ratio is f/7.43; at the aperture of 80mm, the focal length is 600mm and

the focal ratio is f/7.5.

V's focuser comes with a new scaled 360° rotator and finder base, 1.25" and 2" adapters, supporting high-quality visual observation. The multifunctional handle design makes it more portable and easier to connect to the universal finder base and accessories.

60mm mode OTA

Aperture size: 60mm  
Focal length: 360mm  
Focal ratio: f/6  
Objective lens: Triplet air-spaced APO (including two ED glasses)  
Distance from the 2" adapter to the focal plane with the focuser barrel retracted: 150mm  
Total length (without accessories): 318.5mm  
60 mode OTA weight: 2.8kg  
Rear-end adapter type: 2" adapter, 1.25" adapter

80mm mode OTA

Aperture size: 80mm  
Focal length: 500mm  
Focal ratio: f/6.25  
Objective lens: Triplet air-spaced APO (including two ED glasses)  
Distance from the 2" adapter to the focal plane with the focuser barrel retracted: 139.7mm  
Total length (without accessories): 411mm (with the dew shield contracted); 479mm (with the dew shield fully stretched)  
80 mode OTA weight: 3.4kg  
Rear-end adapter type: 2" adapter, 1.25" adapter

Full frame reducer

Weight:0.44kg  
Rear-end adapter: M54×0.75, M48×0.75 (built-in 2" filter thread)  
60mm mode:  
1.Focal length: 270mm  
2.Back focus: 55mm (from the M48 adapter)  
80mm mode:  
1.Focal length: 384mm  
2.Back focus: 55mm (from the M48 adapter)

Full frame flattener

Weight:0.48kg  
Rear-end adapter: M54×0.75, M48×0.75 (built-in 2" filter thread)  
60mm mode:  
1.Focal length: 360mm

2.Back focus: 55mm (from the M48 adapter)  
80mm mode:  
1.Focal length: 495mm  
2.Back focus: 55mm (from the M48 adapter)

Full frame extender

Weight:0.46kg  
Rear-end adapter: M54×0.75, M48×0.75 (built-in 2" filter thread)  
60mm mode:  
1.Focal length: 446mm  
2.Back focus: 55mm (from the M48 adapter)  
80mm mode:  
1.Focal length: 600mm  
2.Back focus: 55mm (from the M48 adapter)

Product Size Diagram

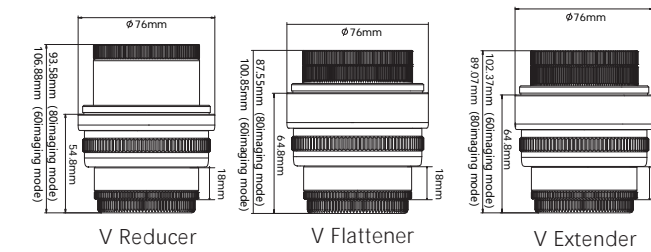
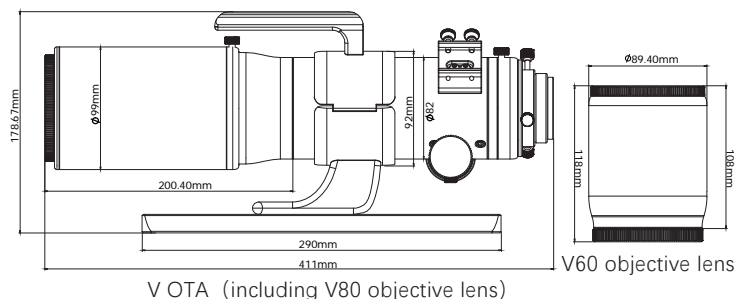

Steps to swap V80 objective lens for V60 objective lens

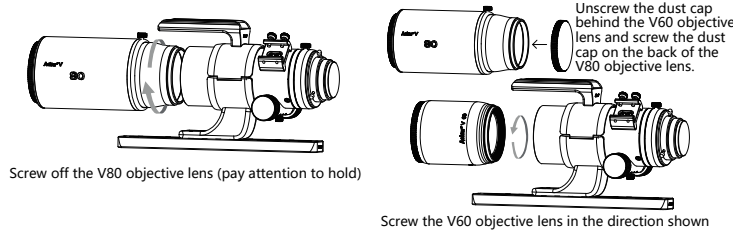

Steps to swap V60 objective lens for V80 objective lens

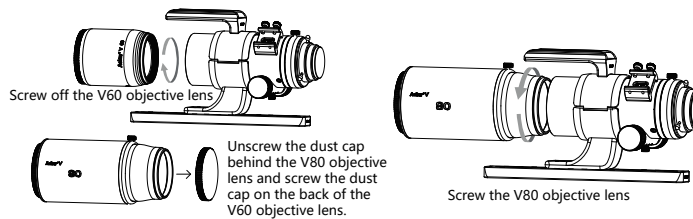

Steps to replace accessories

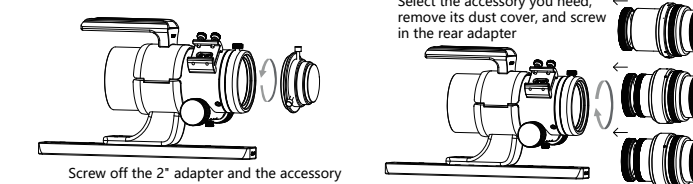

V60 shooting mode to V80 shooting mode

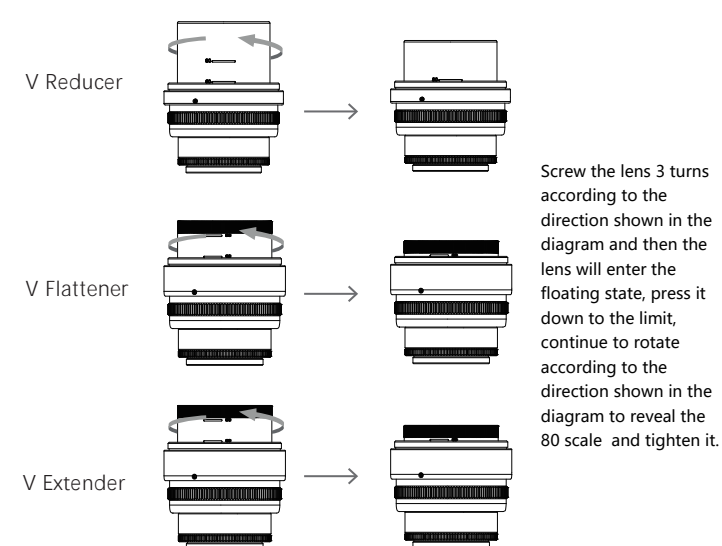

V80 shooting mode to V60 shooting mode

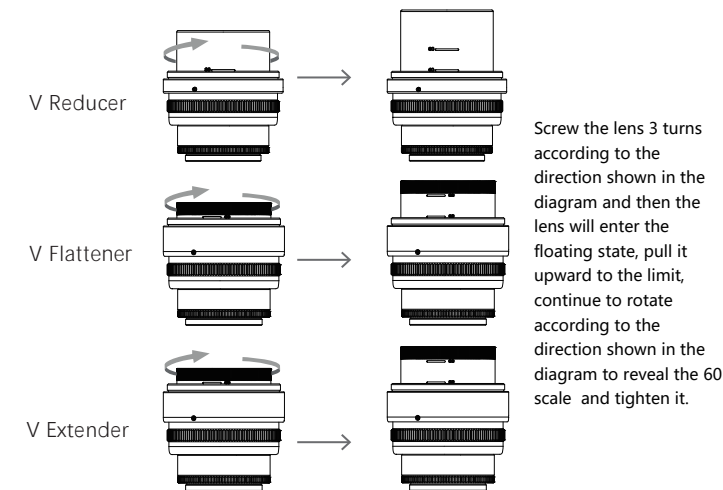

Product Parts Diagram

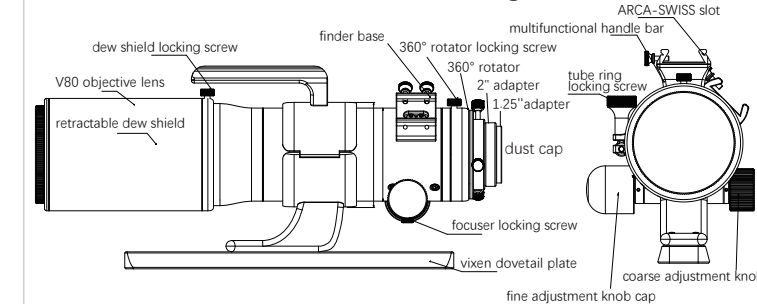

Items in V Packaging

