

Obligation Keeps Excellence

▶ International Sales Hotline
0086-731-27577393

OKE Precision Cutting Tools Co., Ltd.

Head Office Add: Chuangye Rd, Chuangye Park for SMEs, Yanling County, Zhuzhou, Hunan, China.
Branch Office Add: #8, Chuangye Rd, Lusong Area, Zhuzhou, Hunan, China.
Tel: +86 0733-22673968 Fax: +86 0731-22673961
E-mail: oke_info@oke-carbide.com info@oke-carbide.com
Web: www.oke-carbide.com

OKE reserves the final interpretation of this booklet

OKE 欧科亿 Cutting Tools Catalog

2023

OKE 欧科亿

股票代码: 688308

CUTTING TOOLS CATALOG

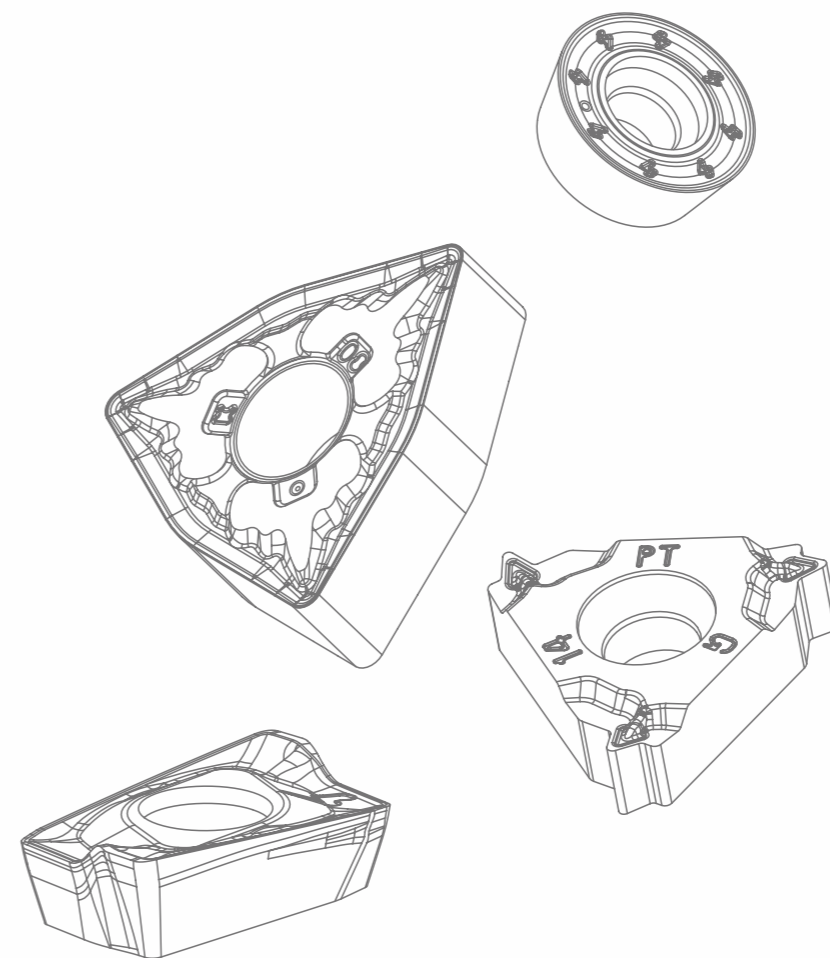

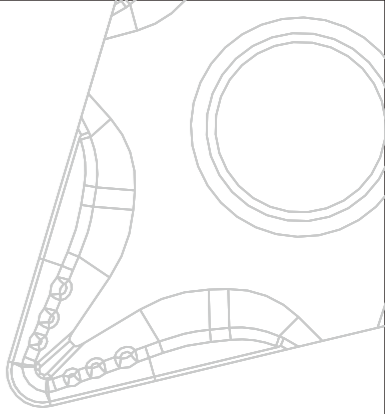

Cutting Tools

A

Turning Tools

B

Milling Tools

C

Drilling Tools

D

Solid End Mill

E

General Technical Guide

COMPANY PROFILE

OKE 欧科亿

Established In Jan 1996, OKE Precision Cutting Tools Co., Ltd. Is A High-Tech Enterprise Specializing In Independent R&D, Production And Sales Of Cemented Carbide And CNC Cutting Tool Products. On 10th Dec. 2020, OKE Was Successfully Listed And Becoming The First Listed Company On The SSE Star Market In Zhuzhou City, Also The First Listed One With Cemented Carbide Tools As Its Main Business.

The CNC Carbide Inserts Output Is Top 2 In China. After Years Of Technological Exploration, OKE Has Mastered The Key Technology System For Manufacturing Of Tungsten Cemented Carbide, CNC Carbide Insert (Tools) And Whole Process Of Integrated Application, Successfully Solved The Control Problem Of Cemented Carbide Performance Stability And Accuracy Consistency. OKE Is Able To Stably Produce Cemented Carbide Tool Products With Complex Structures Such As Ultra-Fine And Low-Cobalt, Ultra-Fine And Ultra-Thin, And Functional Gradients Etc. .The PVD Coated Inserts For Stainless Steel Processing And CVD Coated Inserts For Steel Processing Independently Developed By OKE Have Reached The International Advanced Level And Can Replace Imported Products.



The Leading CNC Cutting Tools
Integrated Supplier and Application
Service Provider in China

OKE 欧科亿



SDKT_

Tornado series square shoulder milling tools

- ✓ Wide range Cutting diameter : $\phi 40-\phi 200\text{mm}$;
- ✓ Positive rake face design gives smooth and light cutting;
- ✓ Under 80mm diameter cutter loaded inner cooling system thus improve cutting tool life time;
- ✓ High precision cutting edge design to provide ultra high perpendicularity and excellent surface quality;
- ✓ Maximum cutting depth up to 10mm.

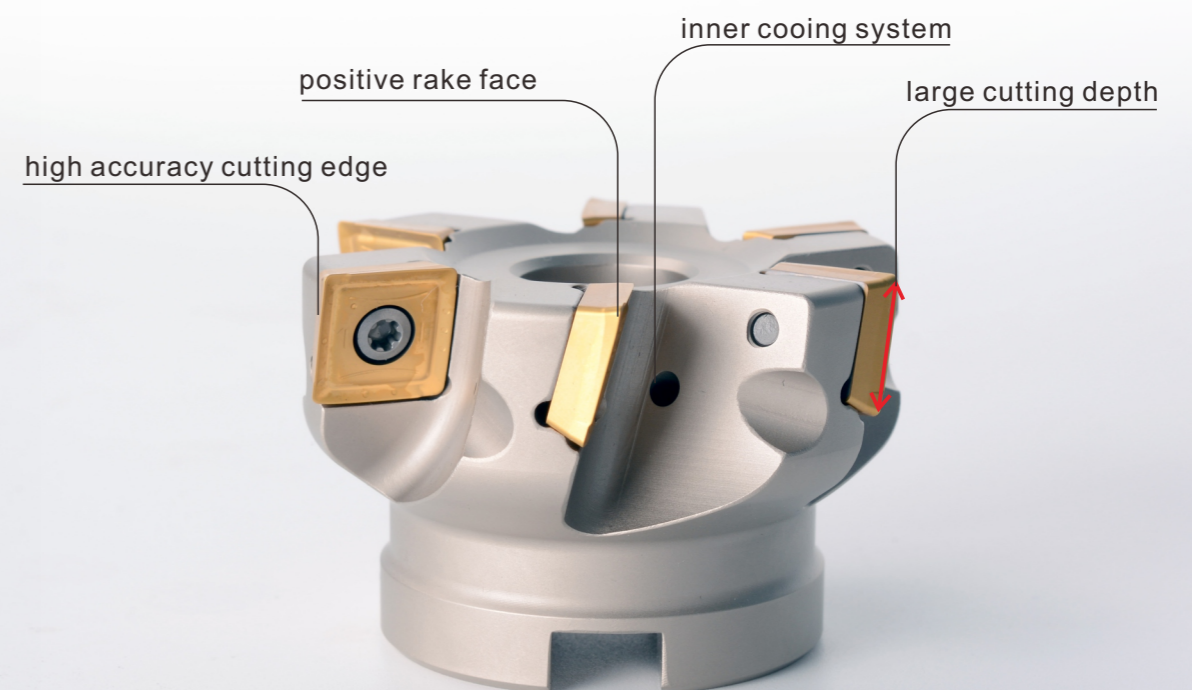



NEW

BXKT_

Beeze series multiple function square shoulder milling tools;

- ✓ Suitable for a variety of milling processing;
- ✓ Micro shape design of cutting edge with drum shape modification;
- ✓ main cutting edge structure adopts large helix angle design;
- ✓ high perpendicularity and excellent surface quality;
- ✓ High precision indexable milling head couple with carbide tool holder to solve vibration problem of long suspension cutting.

drum shape modification



large helix angle main cutting edge



Solid Carbide End Mill



OMPQ versatile end mill series



OMPX series-high performance general use carbide end mills



OMH hardened steel processing series

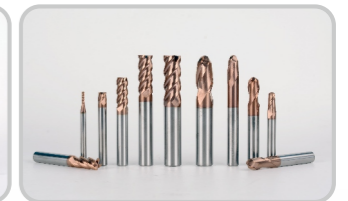

OMHH High hardness steel machining milling cutter series



Cutting Tools for Small Parts Machining

PVD stainless steel
new grade for turning
machining

OP1415

NEW

Performance is
improved by 30%

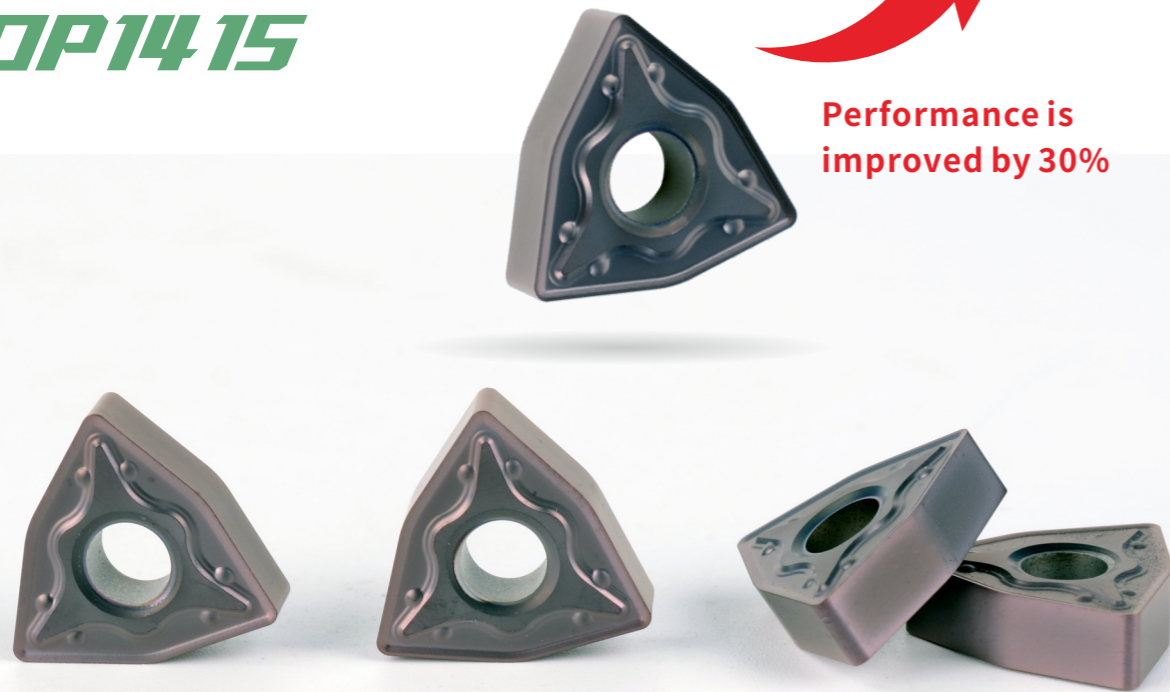

Front sweep tool

Precision small parts processing
4 types of cutting tools (front sweep, back sweep, cutting, grooving);
Stable product performance, used for automatic processing

JF chipbreaker

Better chip handling capacity, suitable for small cutting depth, large feed processing conditions
Excellent cutting effect to obtain good workpiece surface quality

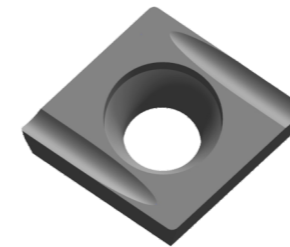

JU chipbreaker

Sharp cutting edge, small resistance, can be used for slender shaft processing
Long cutting edge, the maximum cutting depth is 4mm, high processing efficiency, can meet the demand of "one size fits all"

JY chipbreaker

Wide chipbreaker can ensure smooth cutting
Excellent chip handling capability can improve tool life and chip performance

Recommended machining parameter

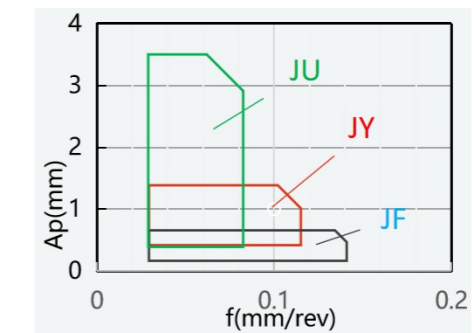

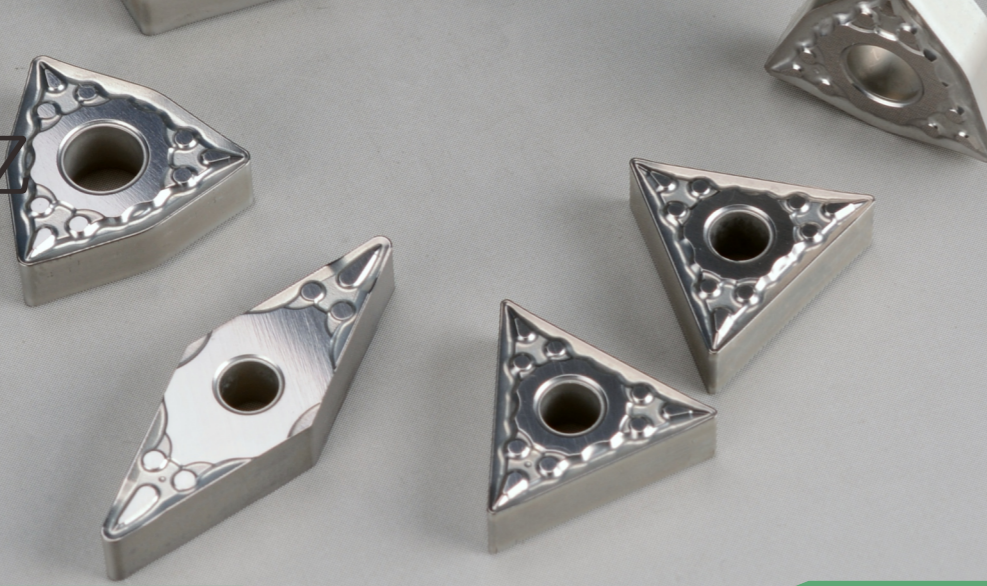

Cermet turning grade
OKE6310

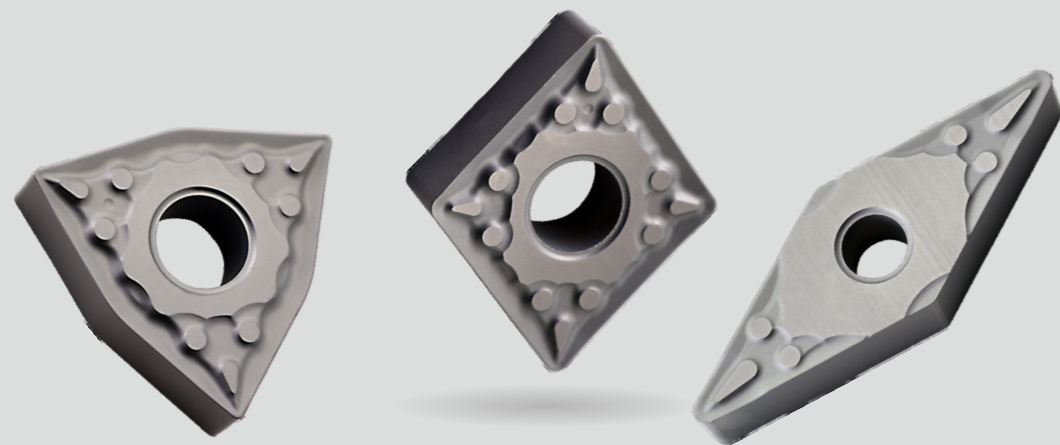

Efficient • Stable **New Generation**
CVD grade Products for Steel Turning

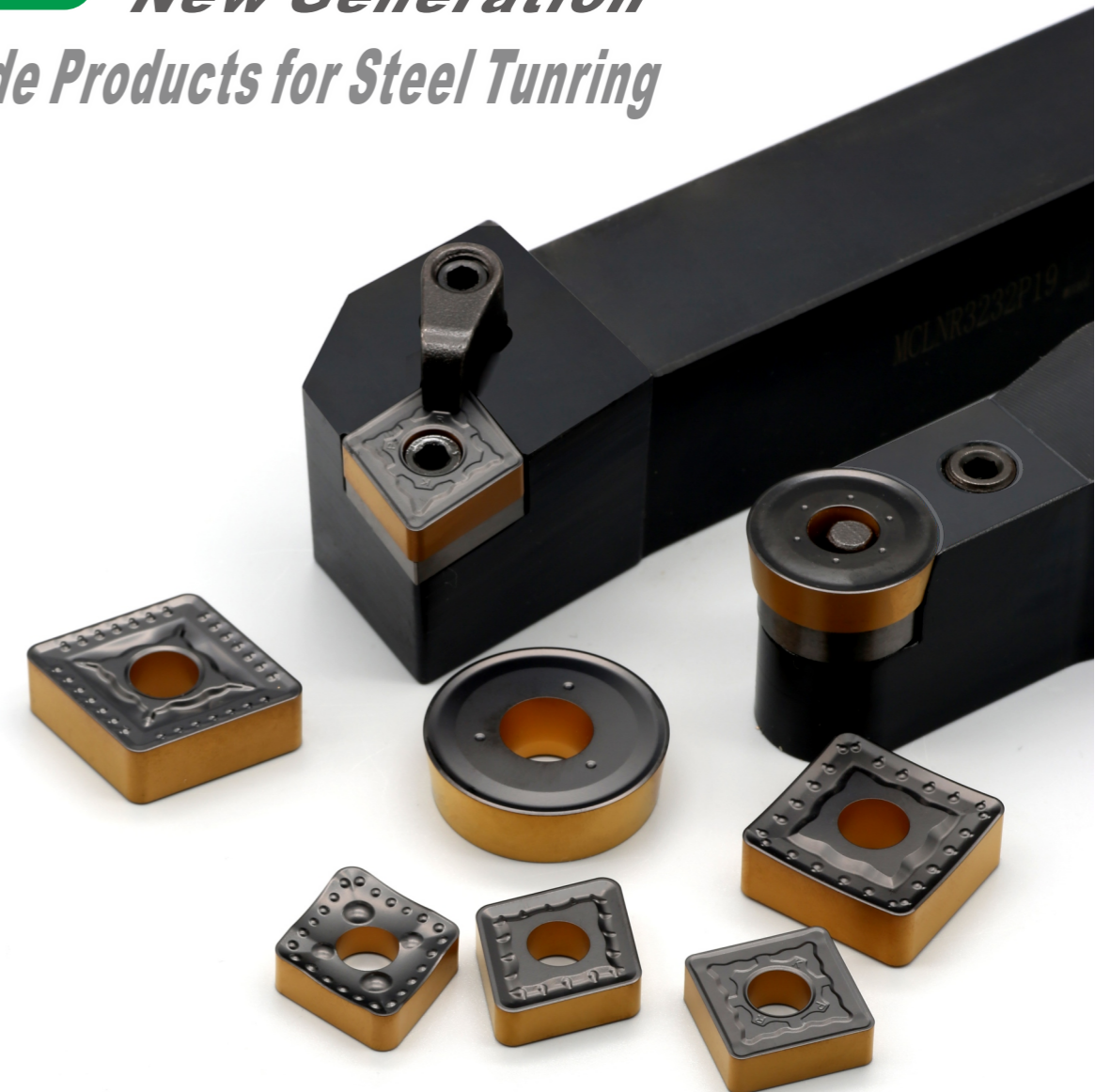

Steel

Finishing

-OPF

Special designed for steel finishing;
Unique design efficiently controls the form of chip and breaks chip;
Sharp cutting edge, smooth cutting;
Excellent surface quality.



-OTF

Special chip breaker structure makes excellent chip breaking even at small cutting depth.
Sharp cutting edge, cutting smoothly and quickly.

Semi-Finishing

-OPM

Negative chamfer designation gives blade good strength;
Double chipbreaker lands, makes bigger chip control range.



-OTM

Flat cutting edge design, good wear-resistance and breakage resistance.
Inclination angle combination structure can control the chip breaking direction efficiently.



Roughing

-OPR

Three-dimension designed with double rake angle, wide margin and negative chamfer;
Wonderful blade intensity gives a longer tool life time;
Suitable for steel roughing machining.



-OTR

Flat cutting edge with big rake angle, gives good wear-resistance.
Varying chip breaker depth design, good performance on chip breaking control.



Stainless Steel

Finishing

-OMF

Special designed rake angle and cutting edge inclination;
Sharp cutting edge, small cutting force;
Good machining surface quality.

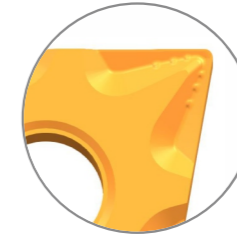

-MSF

Three-dimension designed with double rake angle;
Sharp cutting edge and lower cutting resistance;
Efficiently solved build up edge, work hardening and other machining problems.
Cutting edge inclination designation is good to control chip flow direction and obtains excellent Surface quality.



-OTF

Special chip breaker structure makes excellent chip breaking even at small cutting depth.
Sharp cutting edge, cutting smoothly and quickly.

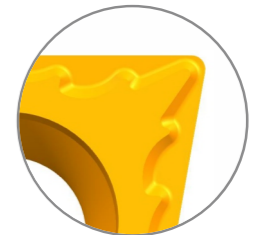

Semi-Finishing

-OMM

Special chipbreaker design to keep cutting edge sharp and safe;
Good anti impact resistance;
Excellent tool life time;



-MF

Special chipbreaker design to keep both sharp cutting edge and increased blade intensity;
Efficiently solved break chip, high cutting temperature, sticking, work hardening and other machining problems.
It has very excellent efficiency



-OTM

Flat cutting edge design, good wear-resistance and breakage resistance.
Inclination angle combination structure can control the chip breaking direction efficiently.

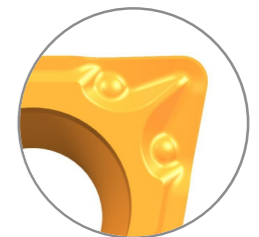

Cast Iron

Finishing To Semi-Finishing

-OKM

Wide support surface for stable clamping and preventing chipping

Sharp cutting edge, improve workpiece surface quality

Excellent chipping resistance in continuous machining

High quality surface roughness



Roughing

-OKR

Wide support surface for stable clamping and preventing chipping

Optimized edge width for high-speed, high-feed machining

Excellent chipping resistance in interrupted machining

Improve machining stability and extend tool life



High Temperature Alloy

Semi-Finishing

-SMM

Three-dimensional groove design with large rake angle;

Sharp cutting edge and low cutting force;

Processing difficulties such as high temperature processing and work hardening;

Suitable for finishing of super-alloy materials.



-OSM

Effectively control chip curling and flow;

Sharp cutting edge, smooth quick cutting;

Proper edge strength gives a longer service life



Aluminum Alloy

-NL

Finishing To Roughing

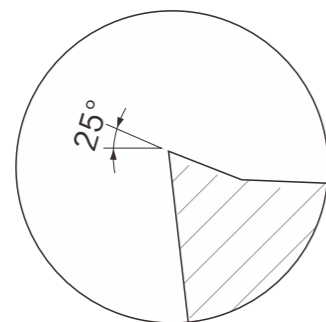
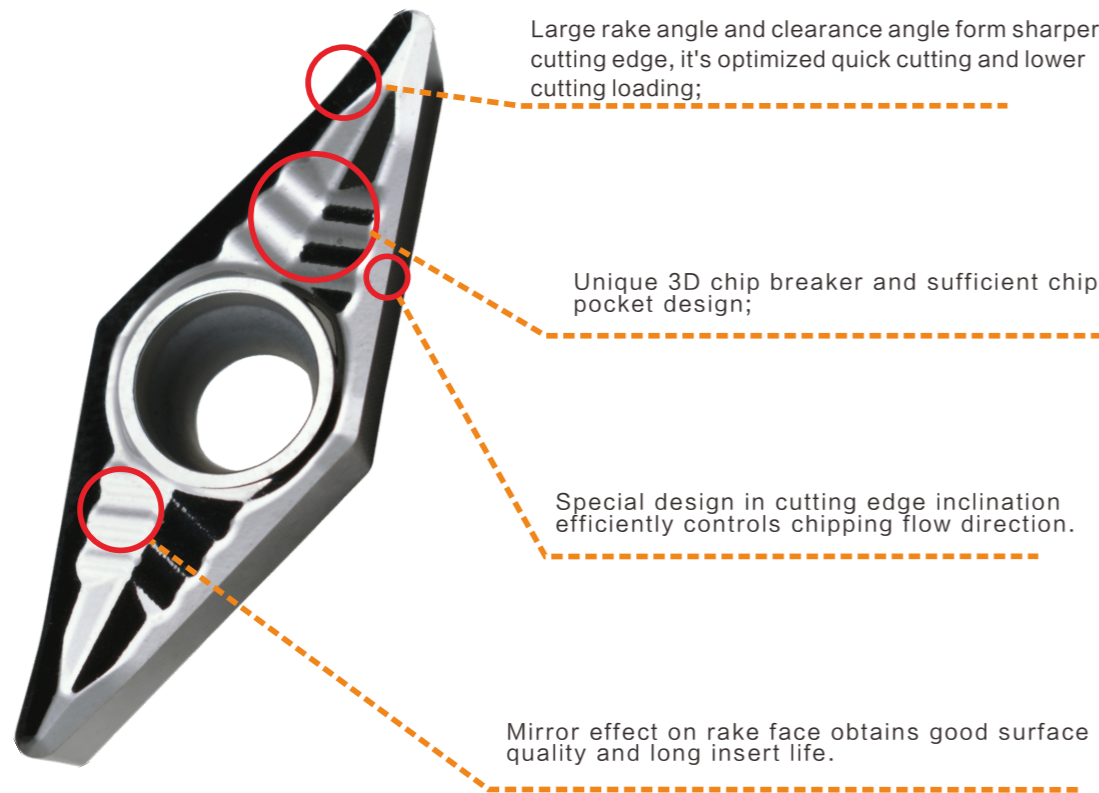

Parting and Grooving

-OC

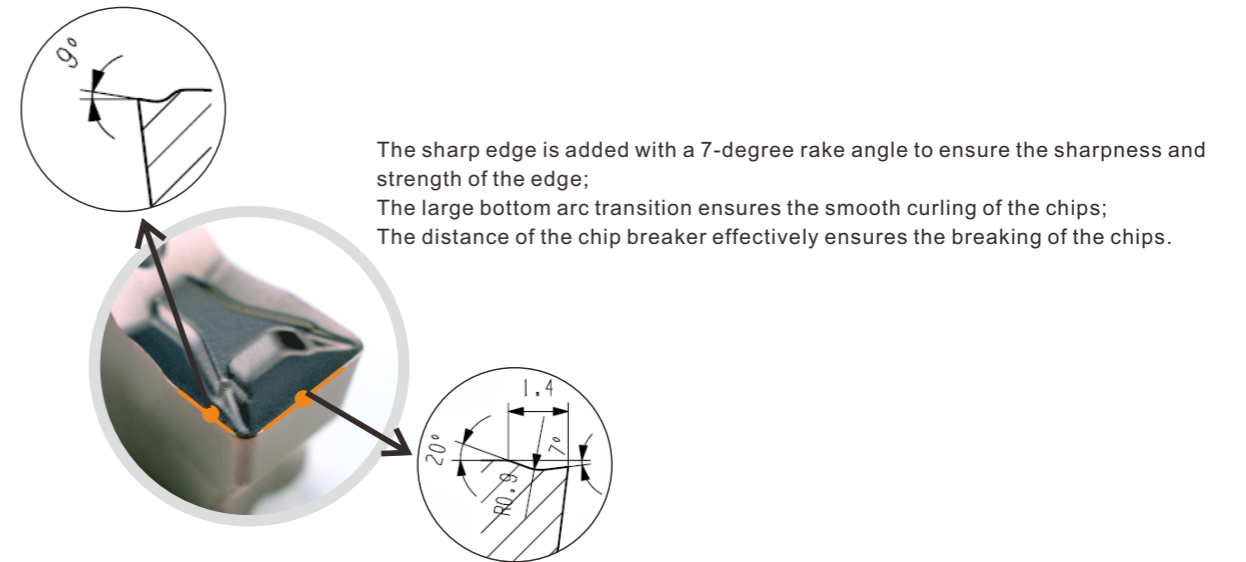

-MG

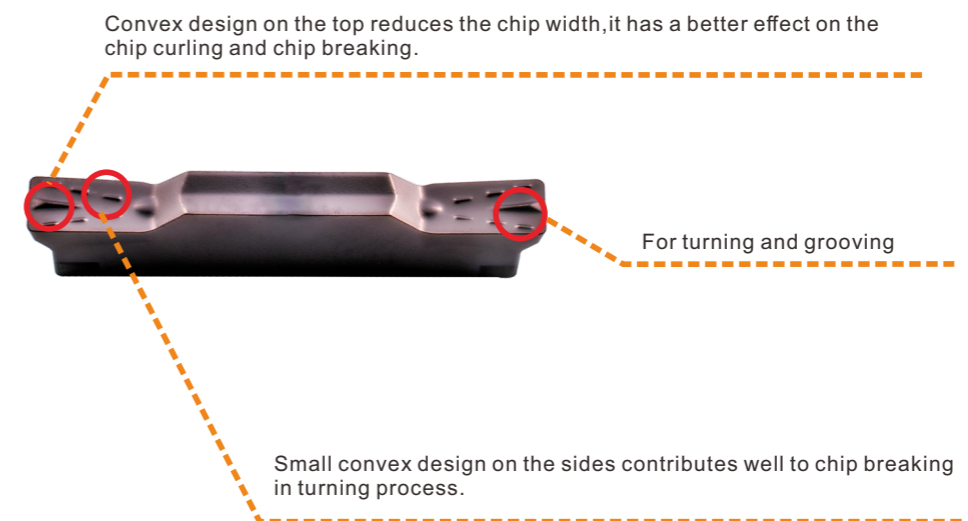

CVD

Grade	Hardness	Coating Type	Colour	Feature
OC2115	1530	CVD	Black	Low Cobalt content, and high cubic content carbide substrate combine with thick TiCN and Al ₂ O ₃ , treated by special after coating treatment, which gives insert wonderful wearing resistance. Preferred grade for semifinishing to finishing steel machining. ●
OC2125	1480	CVD	Black	Low Cobalt content, and high cubic content carbide substrate combine with thick TiCN and Al ₂ O ₃ , treated by special after coating treatment, which gives insert wonderful wearing resistance. Preferred grade for semifinishing to finishing steel machining. ●
OC2325	1480	CVD	Yellow	Medium cobalt content, and high cubic content carbide substrate combine with strong texture TiCN and Al ₂ O ₃ coating. After special treatment, it has wonderful abrasion resistance. ●
OC2325S	1480	CVD	Double color	Gradient hard alloy substrate with rich cubic phase content has better high temperature performance and plastic deformation resistance. The uniform dense and fine-grained coating has excellent wear resistance, and the special transition layer structure ensures the anti-peeling performance of the coating; The unique post-processing technology realizes a two-color marking layer and uniform compressive stress distribution, ensuring higher wear resistance and stability. It is suitable for turning of various steels and is the first choice for wear resistance. ●

CVD

Grade	Hardness	Coating Type	Colour	Feature
OC2425	1470	CVD	Double color	High cubic content gradient carbide substrate, gives good anti-deformation resistance and excellent high temperature performance. Dense and uniform ultra-fine-grained coating, providing excellent wear resistance, unique transition layer structure, to ensure the anti-peeling performance of the coating; unique post-processing technology, realizing two-color and beneficial compressive stress distribution, to achieve higher resistance Abrasiveness and stability. The substrate edge part adopts a unique "skeleton" structure, which achieves excellent cutting performance and good safety. The red hardness of the substrate is further improved by optimizing and adjusting the ratio of raw materials in the solid solution and the particle size of the raw materials. It is suitable for high-efficiency, light-interrupted machining of P10-P20 (medium and high carbon steel, low alloy steel), with a wider application range and better stability. ●
OC3210	1650	CVD	Double color	Fine-grained and high-hardened chemical coating, the substrate has good wear resistance, and achieves stability and long life in a wide range of processing fields. Gray cast iron, ductile iron machining (continuous, light interrupted conditions) Gray cast iron, ductile iron machining (small parts roughing) ●
OC3215	1580	CVD	Black	The medium-coarse substrate combine with thick TiCN and textured Al ₂ O ₃ , after special after coating treatment, it has outstanding wearing resistance. Suitable for high speed semi-finishing cast iron cutting under stable work condition. ●
OC3220	1600	CVD	Double color	MTCVD TiCN-Al ₂ O ₃ coating strengthened by fine-grained α-Al ₂ O ₃ film, the substrate is a kind of hard alloy with good toughness Gray cast iron, ductile iron machining (strong interrupted conditions) Gray cast iron, ductile iron machining (roughing, black skin conditions) ●
OC4315	1480	CVD	Gold	Medium Cobalt content, and high cubic content carbide substrate combine with thin TiCN and Al ₂ O ₃ , treated by special after coating treatment, which gives insert wonderful wearing resistance. Preferred grade for stainless steel turning at high speed. ●

PVD

Grade	Hardness	Coating Type	Colour	Feature
OP1030	1500	PVD	Gray	High Co content and ultra fine WC grain substrate, gives wonderful toughness, combines with PVD AlTiN coating, it has good strength and versatility. Suitable for steel and stainless steel milling and drilling. ● ●
OP1205	1650	PVD	Dark Purple	High Co content and ultra fine WC grain substrate, gives wonderful cutting edge strength, combines with good thermal stability silicon coating, it has very small coefficient of friction, and good nano hardness. Suitable for steel and stainless steel continue turning and threading. ● ●
OP1215	1560	PVD	Dark Purple	High Co content and fine WC grain substrate, gives wonderful cutting edge strength, combines with good thermal stability silicon coating, it has very small coefficient of friction, and good nano hardness. Good at stainless steel semi-finishing turning, parting and grooving processing. preferred grade for steel and stainless steel milling and drilling. ● ●
OP1315	1560	PVD	Gray	High Co content and fine WC grain substrate, gives wonderful cutting edge strength, combines with new AlTiN coating, it has very small coefficient of friction, high antioxidant temperature, and good nano hardness. Preferred grade for steel and stainless steel milling and drilling. ● ●

Grade	Hardness	Coating Type	Colour	Feature
OP1415	1550	PVD	Dark Purple	The coating has dense columnar crystals and small gaps between crystals, which can effectively improve the oxidation resistance and plastic deformation resistance; The lower the roughness of the coating surface, the lower the resistance and heat generated during cutting can be effectively reduced; The bonding force between the film layer and the substrate is strong, which reduces the abnormal cracking of the product and improves the service life of the tool. ●
OP1325	1580	PVD	Yellow	New material substrate has good anti wear resistance and anti impact resistance. Combining with multiple layers AlTiN coating, it has excellent adhesion between coating and substrate which improves tool life significantly. Suitable for general steel, and stainless steel milling. ● ●
OP1630	1520	PVD	Yellow	Newly upgraded coating technology, the new king of steel milling; Enhanced tip design, excellent impact resistance; Improved side, stable fit; With supporting development of steel products, the performance is better; ●
OP2202	1640	PVD	Gray	High Co content and ultra fine WC grain substrate, gives wonderful cutting edge strength, combines with PVD AlTiN coating, it has outstanding wearing resistance. Suitable for steel and cast iron slight milling. ● ●

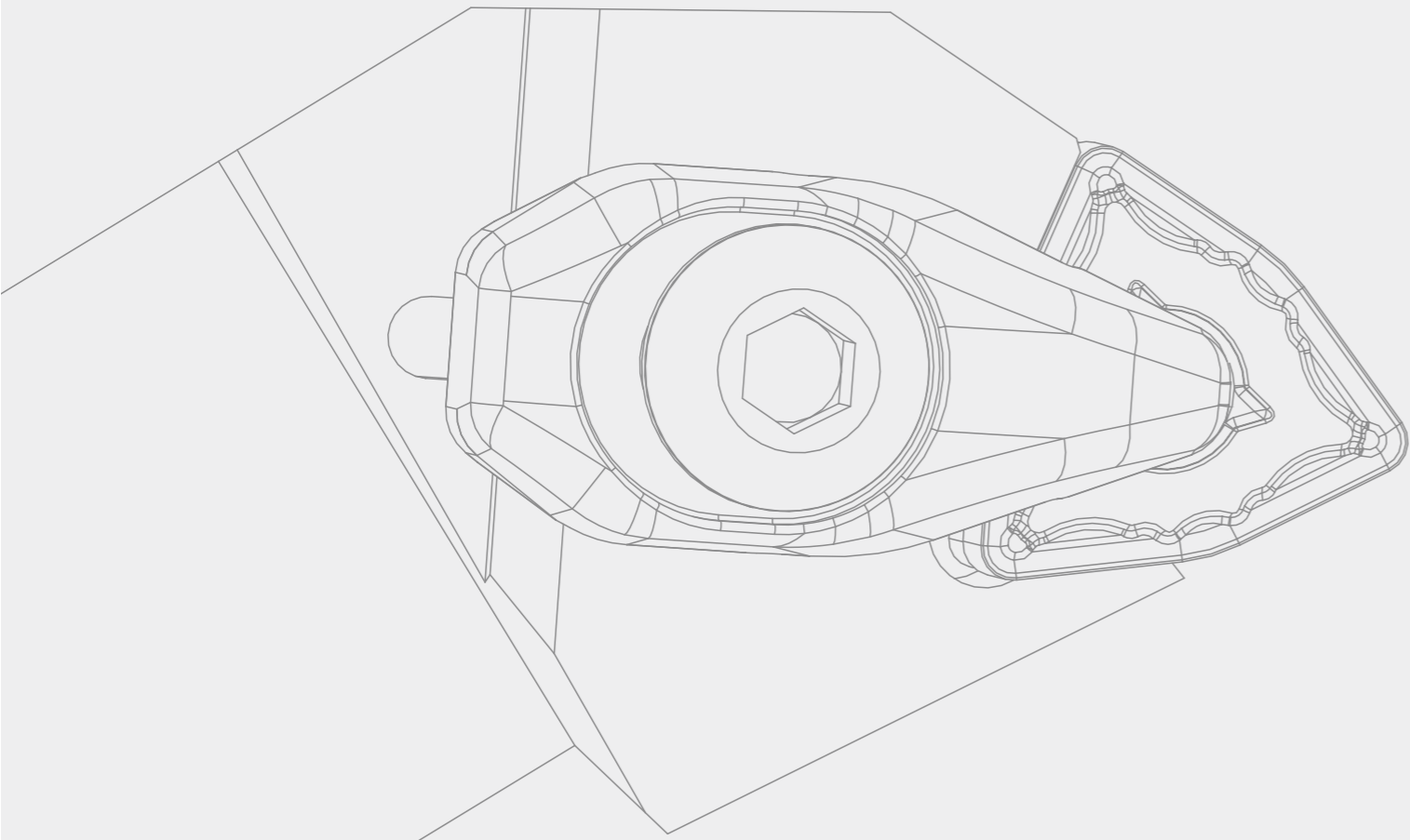

A Turning Tools

a Turning Insert 001-058

b Turning Tools 059-140

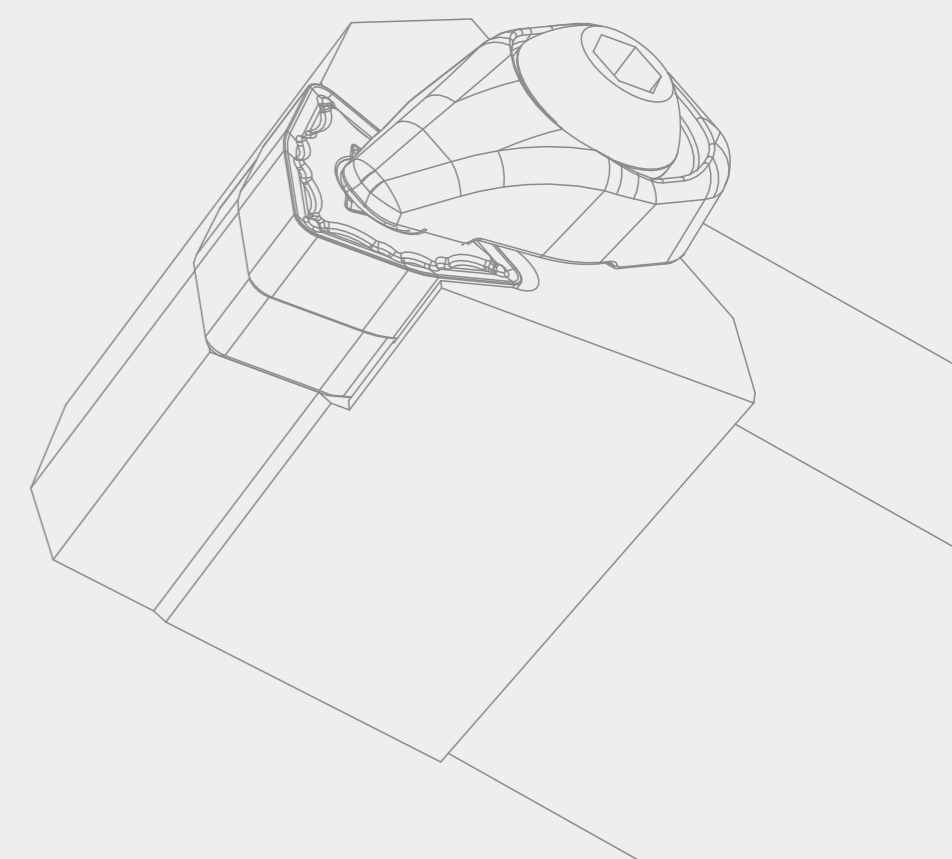

ISO Turning Insert Naming Rules

Shape

C N M G 12 04 08 — OPM

A	B	C
D	E	H
K	L	M
O	P	R
S	T	T
V	W	Z

Chip Breaker and Hole

C N M G 12 04 08 — OPM

Symbol	Center Hole	Chip Breaker	Insert Profile	Symbol	Center Hole	Chip Breaker	Insert Profile
B	(Y)	(N)		N	(N)	(N)	
H	(Y)	(S)		R	(N)	(S)	
C	(Y)	(N)		F	(N)	(D)	
J	(Y)	(D)		A	(Y)	(N)	
W	(Y)	(N)		M	(Y)	(S)	
T	(Y)	(S)		G	(Y)	(D)	
Q	(Y)	(N)		X			
U	(Y)	(D)					

Clearance Angle

C N M G 12 04 08 — OPM

A	B
C	D
E	F
G	N
P	O
	Others

Tolerance

C N M G 12 04 08 — OPM

Symbol	m(mm)	d=i.c. (mm)	s (mm)	(reference)M grade tolerance detail(according to shape, size.) Tolerance of insert nose height						
				Inscribed Circle	Regular Triangle	Square	80° Rhombus	55° Rhombus	35° Rhombus	Round
A	±0.005	±0.025	±0.025	6.35	±0.08	±0.08	±0.08	±0.11	±0.16	...
F	±0.005	±0.013	±0.025	9.525	±0.08	±0.08	±0.08	±0.11	±0.16	...
C	±0.013	±0.025	±0.025	12.7	±0.13	±0.13	±0.13	±0.15
H	±0.013	±0.013	±0.013	15.875	±0.15	±0.15	±0.15	±0.18
E	±0.025	±0.025	±0.025	19.05	±0.15	±0.15	±0.15	±0.18
G	±0.025	±0.025	±0.13	25.4	...	±0.18
J	±0.005	±0.05-±0.13	±0.025	●Tolerance of Inscribed Circle						
K	±0.013	±0.05-±0.13	±0.025	Inscribed Circle	Regular triangle	Square	80° Rhombus	55° Rhombus	35° Rhombus	Round
L	±0.025	±0.05-±0.13	±0.025	6.35	±0.05	±0.05	±0.05	±0.05	±0.05	
M	±0.08-±0.18	±0.05-±0.13	±0.13	9.525	±0.05	±0.05	±0.05	±0.05	±0.05	±0.05
N	±0.08-±0.18	±0.05-±0.13	±0.025	12.7	±0.08	±0.08	±0.08	±0.08	...	±0.08
U	±0.13-±0.38	±0.08-±0.25	±0.13	15.875	±0.1	±0.1	±0.10	±0.10	...	±0.1
				19.05	±0.1	±0.1	±0.10	±0.10	...	±0.1
				25.4	±0.13	±0.13

ISO Turning Insert Naming Rules

Cutting Edge Length

C N M G 12 04 08 — OPM

Inscribed Circle diameter(mm)	Insert Shape							
	C	D	R	S	T	V	W	K
3.97					06			
5			05					
5.56					09			
6			06					
6.35	06	07			11	11		
8			08					
9.525	09	11	09	09	16	16	06	16
10			10					
12			12					
12.7	12	15	12	12	22	22	08	
15.875	16		15	15	27			
16			19	16				
19.05	19		19	19	33			
20			20					
25	25	25	25					
25.4			25	25				
31.75			31					
32			32					

Thickness

C N M G 12 04 08 — OPM

Symbol	Thickness(mm)
00	0.79
T0	0.99
01	1.59
T1	1.98
02	2.38
T2	2.58
03	3.18
T3	3.97
04	4.76
T4	4.96
05	5.56
T5	5.95
06	6.35
T6	6.75
07	7.94
09	9.52
T9	9.72
11	11.11
12	12.7

The Height Between Insert Bottom And Nose

Corner Radius

C N M G 12 04 08 — OPM

Symbol	Corner Radius (mm)
00	
02	0.2
04	0.4
08	0.8
12	1.2
16	1.6
20	2
24	2.4
32	3.2
X	其它 Special

Diameter Dimension Round Insert

Chip Breaker

C N M G 12 04 08 — OPM

OPF	OPM	OPR	OMF	OMM
MF	MSF	OTF	OTM	OTR
OKM	OKR	OSM	SMM	NL

Inserts Overview

CNMG-OPF	CNMG-OMF	CNMG-MSF	CNMG-OPM	CNMG-OMM	CNMG-MF
					
EdgeLength	12.9	EdgeLength	12.9	EdgeLength	9.7 12.9
EdgeLength	12.9	EdgeLength	12.9	EdgeLength	12.9 16.1 19.3
EdgeLength	12.9	EdgeLength	12.9	EdgeLength	12.9 16.1
CNMG-OKM	CNMG-OSM	CNMG-SMM	CNMG-OPR	CNMG-OMR	CNMG-OKR
					
EdgeLength	12.9	EdgeLength	12.9	EdgeLength	12.9
EdgeLength	12.9	EdgeLength	12.9	EdgeLength	12.9 16.1 19.3
EdgeLength	12.9	EdgeLength	12.9	EdgeLength	12.9 16.1
CNMM-PR	CNMM-PR	CNMG	CNMA	DNMG-OPF	DNMG-OMF
					
EdgeLength	19.3	EdgeLength	25.8	EdgeLength	12.7 16.1 19.3
EdgeLength	19.3	EdgeLength	25.8	EdgeLength	12.7 16.1 19.3
EdgeLength	19.3	EdgeLength	25.8	EdgeLength	11.6 15.5
EdgeLength	19.3	EdgeLength	25.8	EdgeLength	15.5
DNMG-MSF	DNMG-OPM	DNMG-OMM	DNMG-MF	DNMG-OKM	DNMG-OSM
					
EdgeLength	11.6 15.5	EdgeLength	11.6 15.5	EdgeLength	11.6 15.5
EdgeLength	11.6 15.5	EdgeLength	11.6 15.5	EdgeLength	11.6 15.5
EdgeLength	11.6 15.5	EdgeLength	11.6 15.5	EdgeLength	15.5
EdgeLength	11.6 15.5	EdgeLength	11.6 15.5	EdgeLength	15.5
DNMG-OPR	DNMG-OKR	DNMG	DNMA	SNMG-OPF	SNMG-OMF
					
EdgeLength	15.5	EdgeLength	15.5	EdgeLength	11.6 15.5
EdgeLength	15.5	EdgeLength	15.5	EdgeLength	15.5
EdgeLength	15.5	EdgeLength	15.5	EdgeLength	12.7
EdgeLength	15.5	EdgeLength	15.5	EdgeLength	12.7
SNMG-OPM	SNMG-OMM	SNMG-MF	SNMG-OKM	SNMG-OSM	SNMG-SMM
					
EdgeLength	12.7 15.875 19.05	EdgeLength	12.7 15.875	EdgeLength	12.7
EdgeLength	12.7 15.875 19.05	EdgeLength	12.7	EdgeLength	12.7
EdgeLength	12.7 15.875 19.05	EdgeLength	12.7	EdgeLength	12.7
EdgeLength	12.7 15.875 19.05	EdgeLength	12.7	EdgeLength	12.7

Inserts Overview

SNMG-OPR	SNMM-OPR	SNMG-OKR	SNMM-PR	SNMG	SNMA
					
EdgeLength	12.7 15.875 19.05	EdgeLength	19.05	EdgeLength	12.7 15.875 19.05 25.4
EdgeLength	12.7 15.875 19.05	EdgeLength	19.05	EdgeLength	12.7 15.875 19.05 25.4
EdgeLength	12.7 15.875 19.05	EdgeLength	19.05	EdgeLength	12.7
TNMG-OPF	TNMG-OMF	TNMG-MSF	TNMG-OPM	TNMG-OMM	TNMG-MF
					
EdgeLength	16.5	EdgeLength	16.5	EdgeLength	16.5 22
EdgeLength	16.5	EdgeLength	16.5	EdgeLength	16.5 22
EdgeLength	16.5	EdgeLength	16.5	EdgeLength	16.5 22
TNMG8-OKM	TNMG-SMM	TNMG-OPR	TNMG-OMR	TNMG-OKR	TNMG
					
EdgeLength	16.5	EdgeLength	16.5	EdgeLength	16.5 22 27.5
EdgeLength	16.5	EdgeLength	16.5	EdgeLength	16.5
EdgeLength	16.5	EdgeLength	16.5	EdgeLength	16.5
EdgeLength	16.5	EdgeLength	16.5	EdgeLength	16.5 22
TNMA	VNMG-OPF	VNMG-MSF	VNMG-OPM	VNMG-OMM	VNMG-MF
					
EdgeLength	16.5 22	EdgeLength	16.6	EdgeLength	16.6
EdgeLength	16.5 22	EdgeLength	16.6	EdgeLength	16.6
EdgeLength	16.5 22	EdgeLength	16.6	EdgeLength	16.6
EdgeLength	16.5 22	EdgeLength	16.6	EdgeLength	16.6
VNMG-OKM	VNMG-SMM	VNMG-OPR	VNMG-OKR	VNMG	VNMA
					
EdgeLength	16.6	EdgeLength	16.6	EdgeLength	16.6
EdgeLength	16.6	EdgeLength	16.6	EdgeLength	16.6
EdgeLength	16.6	EdgeLength	16.6	EdgeLength	16.6
EdgeLength	16.6	EdgeLength	16.6	EdgeLength	16.6
WNMG-OPF	WNMG-OMF	WNMG-MSF	WNMG-OPM	WNMG-OMM	WNMG8-MF
					
EdgeLength	6.5	EdgeLength	6.5 8.7	EdgeLength	6.5 8.7
EdgeLength	6.5	EdgeLength	6.5 8.7	EdgeLength	6.5 8.7
EdgeLength	6.5	EdgeLength	6.5 8.7	EdgeLength	6.5 8.7
EdgeLength	6.5	EdgeLength	6.5 8.7	EdgeLength	6.5 8.7

Inserts Overview

WNMG-OKM	WNMG-SMM	WNMG-OPR	WNMG-OMR	WNMG-OKR	WNMG
					
EdgeLength 8.7	EdgeLength 8.7	EdgeLength 8.7	EdgeLength 8.7	EdgeLength 8.7	EdgeLength 8.7
WNMA	CCMT-OTF	CCMT-MSF	CCMT-OTM	CCMT-OTR	DCMT-OTF
					
EdgeLength 8.7	EdgeLength 6.4 9.7 12.9	EdgeLength 6.4 9.7 12.9	EdgeLength 6.4 9.7 12.9	EdgeLength 6.4 9.7 12.9	EdgeLength 7.8 11.6
DCMT-MSF	DCMT-OTM	DCMT-OTR	RCMXMO	RCMXMO-Q	RCMTMO
					
EdgeLength 7.8 11.6	EdgeLength 7.8 11.6	EdgeLength 11.6	EdgeLength 8.0	EdgeLength 12 16 20 25 32	EdgeLength 8.0
RCMTMO-Q	SCMT-OTF	SCMT-OTM	SCMT-OTR	TCMT-OTF	TCMT-OTM
					
EdgeLength 16	EdgeLength 9.525 12.7	EdgeLength 9.525 12.7	EdgeLength 9.525 12.7	EdgeLength 11 16.5	EdgeLength 9.6 11 16.5
TCMT-OTR	VBMT-OTF	VBMT-OTM	VBMT-OMM	VBMT-OSM	VBMT-OTR
					
EdgeLength 16.5 22	EdgeLength 16.5	EdgeLength 11 16.5	EdgeLength 16.5	EdgeLength 16.5	EdgeLength 16.5
VCMT-OTF	VCMT-OTM	VCMT-OSM	TPGH	KNUX	175.32
					
EdgeLength 11 16.5	EdgeLength 16.5	EdgeLength 16.5	EdgeLength 6.4 8.2 9.6 11	EdgeLength 16.2	EdgeLength 19.1

Inserts Overview



175.32

EdgeLength 19.1

Insert for Aluminum

CCGX-NL	DCGX-NL	RCGT-NL	SCGX-NL	TCGX-NL	VCGX-NL
					
EdgeLength 6.4 9.7 12.9	EdgeLength 7.8 11.6	EdgeLength 6.5 8.7	EdgeLength 9.525 12.7	EdgeLength 9.6 11 16.5	EdgeLength 11 16.5 22

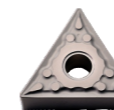
Cermet Inserts

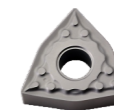



CNMG-SAL	TNMG-SAL	VNMG-SAL	WNM-SAL
			
EdgeLength 12.9	EdgeLength 16.5	EdgeLength 16.6	EdgeLength 8.7

Parting and Grooving Inserts

Q□□D-MG	Q□□W-OC
	
EdgeLength 2.5 3 4 5 6	EdgeLength 2 2.5 3 4 5

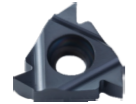
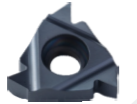
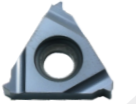
Inserts Overview

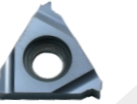
Threading Insert

60° general pitch threads	55° general pitch threads	ISO metric threads	Unified thread (American standard thread)	Whitworth threads	British standard taper pipe threads
 P47	 P48	 P49	 P50	 P51	 P52

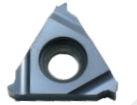
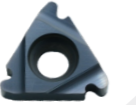
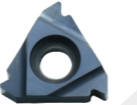
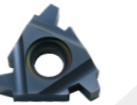
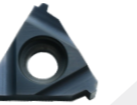
NPT American standard taper pipe threads	UNJ American standard aerospace and aviation threads	30° DIN405 round threads	Petroleum pipeline threads	30° ISO metric threading insert	29° American standard ACME threads
 P53	 P54	 P55	 P56	 P56	 P57

29° American standard STACME threads
 P58

Chipbreaker Introduction Chart

ISO Code	P	P/M	M	K	N	S
Finishing	OPF OPF Chip Breaker: Suitable for finishing ISO P material.	OTF OTF Chip Breaker: Suitable for finishing ISO P and M material.	OMF OMF Chip Breaker: Suitable for finishing ISO M material.			
			MSF MSF Chip Breaker: Suitable for finishing ISO M material.			
Semi Finishing	OPM OPM Chip Breaker: Suitable for semi-finishing ISO P material.	OTM OTM Chip Breaker: Suitable for semi-finishing ISO P and M material.	MF MF Chip Breaker: Suitable for semi-finishing ISO M material.	OKM Suitable for gray cast iron, nodular cast iron continuous/slight interrupt cutting		SMM Suitable for long time continuous semi-finishing to finishing cutting.
			OMM OMM Chip Breaker: Suitable for semi-finishing ISO M material.	General Chipbreaker: General Chip Breaker: Suitable for cast iron semi-finishing cutting.	NL NL Chip Breaker: Suitable for aluminum and aluminum alloy material.	OSM OSM Chip Breaker: Suitable for hi-temp alloy semi-finishing machining
Roughing	OPR OPR Chip Breaker: Suitable for roughing ISO P material.	OTR OTR Chip Breaker: Suitable for finishing ISO M material.		OKR Suitable for gray cast iron, nodular cast iron interrupt and roughing cutting at high feed, and high speed.		
				Flat: Flat Chip Breaker: Suitable for cast iron roughing cutting		

Grade Overview

ISO Usage	ISO Turning			Threading	Parting and Grooving			Milling			Drilling	
	Coating			Coating	Coating			Coating			Coating	
	CVD	PVD	Uncoated Carbide	PVD	CVD	PVD	Uncoated Carbide	CVD	PVD	Uncoated Carbide	CVD	PVD
Steel	01			OP1210								
	10	OC2115				OP1215		OP1215				
	20	OC2125, OC2325, OC2325S, OC2425						OP1215, OP1315, OP1325, OP1630, OP2202				
	30											
	40											
Stainless Steel	01	OC4315		OP1210								
	10		OP1215, OP1315, OP1415			OP1215					OP1215	
	20							OP1215, OP1315, OP1325				OP1030
	30											
	40											
Cast Iron	01							OP2202				OP1215
	10		OC3215, OC3220		OC4020							
	20	OC3210										
	30											
	40											
Aluminum Alloy	01											
	10			OK434								
	20											
	30											
	40											
Hi-temp Alloy	01											
	10											
	20											
	30											
	40											

Turning Insert (Negative) CN□□

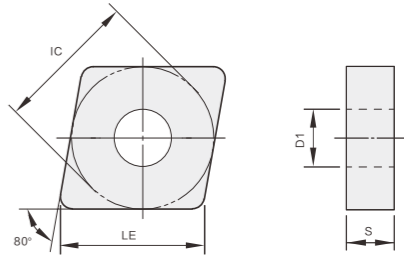

Insert Shape	Type	Dimension					RE	P				M			K		S						
		LE	IC	S	D1	RE		OC2115	OC2125	OC2325	OC2325S	OC2425	OP1215	OP1315	OP1415	OC4315	OC3210	OC3215	OC3220	OP1105	OP6115	OP6215	
	CNMG120404-OPF	12.9	12.7	4.76	5.16	0.4	●	●	▲														
	CNMG120408-OPF	12.9	12.7	4.76	5.16	0.8	●	●	▲														
	CNMG120404-OMF	12.9	12.7	4.76	5.16	0.4					●	●	▲										
	CNMG120408-OMF	12.9	12.7	4.76	5.16	0.8					●	●	▲										
	CNMG090304-MSF	9.7	9.525	3.18	3.81	0.4					●	●	▲										
	CNMG120404-MSF	12.9	12.7	4.76	5.16	0.4					●	●	▲										
	CNMG120404-OPM	12.9	12.7	4.76	5.16	0.4	●	●	▲														
	CNMG120408-OPM	12.9	12.7	4.76	5.16	0.8	●	●	▲														
	CNMG120412-OPM	12.9	12.7	4.76	5.16	1.2	●	●	▲														
	CNMG120416-OPM	12.9	12.7	4.76	5.16	1.6	●	●	▲														
	CNMG160608-OPM	16.1	15.875	6.35	6.35	0.8	●	●	▲														
	CNMG160612-OPM	16.1	15.875	6.35	6.35	1.2	●	●	▲														
	CNMG160616-OPM	16.1	15.875	6.35	6.35	1.6	●	●	▲														
	CNMG190608-OPM	19.3	19.05	6.35	7.94	0.8	●	●	▲	▲													
CNMG190612-OPM	19.3	19.05	6.35	7.94	1.2	●	●	▲	▲														
CNMG190616-OPM	19.3	19.05	6.35	7.94	1.6	●	●	▲	▲														

▲ Featured grade ● Optional grade

Turning Insert (Negative) CN□□

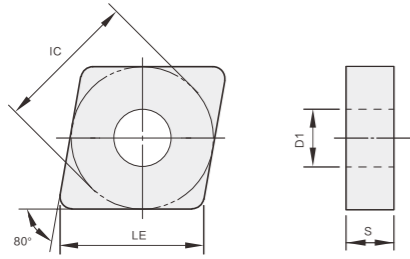

Insert Shape	Type	Dimension					P					M			K		S						
		LE	IC	S	D1	RE	OC2115	OC2125	OC2325	OC2325S	OC2425	OP1215	OP1315	OP1415	OC4315	OC3210	OC3215	OC3220	OP1105	OP6115	OP6215		
	CNMG120404-OMM	12.9	12.7	4.76	5.16	0.4						●	▲	●									
	CNMG120408-OMM	12.9	12.7	4.76	5.16	0.8						●	▲	●									
	CNMG160608-OMM	16.1	15.875	6.35	6.35	0.8						●	▲	●									
	CNMG090308-MF	9.7	9.525	3.18	3.81	0.8						●	▲	●									
	CNMG120404-MF	12.9	12.7	4.76	5.16	0.4						●	▲	●									
	CNMG120408-MF	12.9	12.7	4.76	5.16	0.8						●	▲	●									
	CNMG120412-MF	12.9	12.7	4.76	5.16	1.2						●	▲	●									
	CNMG160612-MF	16.1	15.875	6.35	6.35	1.6						●	▲	●									
	CNMG120404-OKM	12.9	12.7	4.76	5.16	0.4									▲	▲							
	CNMG120408-OKM	12.9	12.7	4.76	5.16	0.8									▲	▲							
	CNMG120412-OKM	12.9	12.7	4.76	5.16	1.2									▲	▲							
	CNMG120408-OSM	12.9	12.7	4.76	5.16	0.8														●			
	CNMG120412-OSM	12.9	12.7	4.76	5.16	1.2														●			
	CNMG120408-SMM	12.9	12.7	4.76	5.16	0.8														▲	▲		
	CNMG120404-SMM	12.9	12.7	4.76	5.16	0.4														▲	▲		

Semi Finishing

Turning Insert (Negative) CN□□

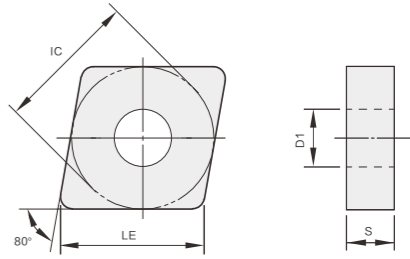

Insert Shape	Type	Dimension					P					M			K		S					
		LE	IC	S	D1	RE	OC2115	OC2125	OC2325	OC2325S	OC2425	OP1215	OP1315	OP1415	OC4315	OC3210	OC3215	OC3220	OP1105	OP6115	OP6215	
	CNMG120408-OPR	12.9	12.7	4.76	5.16	0.8	●	●	▲													
	CNMG120412-OPR	12.9	12.7	4.76	5.16	1.2	●	●	▲													
	CNMG120416-OPR	12.9	12.7	4.76	5.16	1.6	●	●	▲													
	CNMG160608-OPR	16.1	15.875	6.35	6.35	0.8	●	●	▲													
	CNMG160612-OPR	16.1	15.875	6.35	6.35	1.2	●	●	▲													
	CNMG160616-OPR	16.1	15.875	6.35	6.35	1.6	●	●	▲													
	CNMG190608-OPR	19.3	19.05	6.35	7.94	0.8	●	●	▲	▲												
	CNMG190612-OPR	19.3	19.05	6.35	7.94	1.2	●	●	▲	▲												
	CNMG190616-OPR	19.3	19.05	6.35	7.94	1.6	●	●	▲	▲												
	CNMG120408-OMR	12.9	12.7	4.76	5.16	0.8						●	▲	●								
	CNMG120412-OMR	12.9	12.7	4.76	5.16	1.2						●	▲	●								
	CNMG120408-OKR	12.9	12.7	4.76	5.16	0.8														▲	▲	
	CNMG120412-OKR	12.9	12.7	4.76	5.16	1.2														▲	▲	
	CNMG120416-OKR	12.9	12.7	4.76	5.16	1.6														▲	▲	
	CNMG160612-OKR	16.1	15.8	6.35	6.35	1.2														▲	▲	
	CNMM190616-PR	19.3	19.05	6.35	7.94	1.6	●	●	▲													
	CNMM250924-PR	25.8	25.4	9.72	9.12	2.4								▲								
	CNMM250724-PR	25.8	25.4	7.94	9.12	2.4								▲								

Roughing

Heavy Duty Machining

▲ Featured grade ● Optional grade

Turning Insert (Negative) CN□□

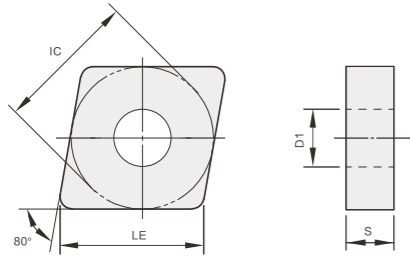

Insert Shape	Type	Dimension					P				M				K		S					
		LE	IC	S	D1	RE	OC2115	OC2125	OC2325	OC2325S	OC2425	OP1215	OP1315	OP1415	OC4315	OC3210	OC3215	OC3220	OP1105	OP6115	OP6215	
	CNMG120404	12.9	12.7	4.76	5.16	0.4	●	●	▲							▲						
	CNMG120408	12.9	12.7	4.76	5.16	0.8	●	●	▲							▲						
	CNMG120412	12.9	12.7	4.76	5.16	1.2	●	●	▲							▲						
	CNMG160608	16.1	15.875	6.35	6.35	0.8	●	●	▲							▲						
	CNMG160612	16.1	15.875	6.35	6.35	1.2	●	●	▲							▲						
	CNMG160616	16.1	15.875	6.35	6.35	1.6	●	●	▲							▲						
	CNMG190608	19.3	19.05	6.35	7.94	0.8	●	●	▲							▲						
	CNMG190612	19.3	19.05	6.35	7.94	1.2	●	●	▲							▲						
	CNMG190616	19.3	19.05	6.35	7.94	1.6	●	●	▲							▲						
	CNMA120404	12.9	12.7	4.76	5.16	0.4										▲						
	CNMA120408	12.9	12.7	4.76	5.16	0.8										▲						
	CNMA120412	12.9	12.7	4.76	5.16	1.2										▲						
	CNMA120416	12.9	12.7	4.76	5.16	1.6										▲						
	CNMA160608	16.1	15.875	6.35	6.35	0.8										▲						
	CNMA160612	16.1	15.875	6.35	6.35	1.2										▲						
	CNMA160616	16.1	15.875	6.35	6.35	1.6										▲						
	CNMA190612	19.3	19.05	6.35	7.94	1.2										▲						
	CNMA190616	19.3	19.05	6.35	7.94	1.6										▲						

Turning Insert (Negative) DN□□

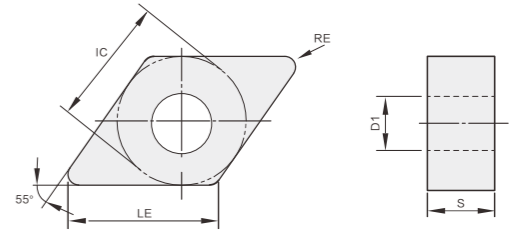

Insert Shape	Type	Dimension					P				M				K		S					
		LE	IC	S	D1	RE	OC2115	OC2125	OC2325	OC2325S	OC2425	OP1215	OP1315	OP1415	OC4315	OC3210	OC3215	OC3220	OP1105	OP6115	OP6215	
	DNMG110404-OPF	11.6	9.525	4.76	3.81	0.4	●	●	▲													
	DNMG110408-OPF	11.6	9.525	4.76	3.81	0.8	●	●	▲													
	DNMG150404-OPF	15.5	12.7	4.76	5.16	0.4	●	●	▲													
	DNMG150408-OPF	15.5	12.7	4.76	5.16	0.8	●	●	▲													
	DNMG150604-OPF	15.5	12.7	6.35	5.16	0.4	●	●	▲													
	DNMG150608-OPF	15.5	12.7	6.35	5.16	0.8	●	●	▲													
	DNMG150604-OMF	15.5	12.7	6.35	5.16	0.4					●	▲	●									
	DNMG150608-OMF	15.5	12.7	6.35	5.16	0.8					●	▲	●									
	DNMG110404-MSF	11.6	9.525	4.76	3.81	0.4					●	▲	●									
	DNMG150404-MSF	15.5	12.7	4.76	5.16	0.4					●	▲	●									
	DNMG110404-OPM	11.6	9.525	4.76	3.81	0.4	●		▲													
	DNMG110408-OPM	11.6	9.525	4.76	3.81	0.8	●		▲													
	DNMG110412-OPM	11.6	9.525	4.76	3.81	1.2	●		▲													
	DNMG150404-OPM	15.5	12.7	4.76	5.16	0.4	●		▲													
	DNMG150408-OPM	15.5	12.7	4.76	5.16	0.8	●		▲													
	DNMG150412-OPM	15.5	12.7	4.76	5.16	1.2	●		▲													
	DNMG150604-OPM	15.5	12.7	6.35	5.16	0.4	●		▲													
	DNMG150608-OPM	15.5	12.7	6.35	5.16	0.8	●		▲													
	DNMG150612-OPM	15.5	12.7	6.35	5.16	1.2	●		▲													
	DNMG110404-OMM	11.6	9.525	4.76	3.81	0.4					●	▲	●									
	DNMG110408-OMM	11.6	9.525	4.76	3.81	0.8					●	▲	●									
	DNMG150404-OMM	15.5	12.7	4.76	5.16	0.4					●	▲	●									
	DNMG150408-OMM	15.5	12.7	4.76	5.16	0.8					●	▲	●									
	DNMG150604-OMM	15.5	12.7	6.35	5.16	0.4					●	▲	●									
	DNMG150608-OMM	15.5	12.7	6.35	5.16	0.8					●	▲	●									
	DNMG150612-OMM	15.5	12.7	6.35	5.16	1.2					●	▲	●									
	DNMG110408-MF	11.6	9.525	4.76	3.81	0.8					●	▲	●									
	DNMG150408-MF	15.5	12.7	4.76	5.16	0.8					●	▲	●									
DNMG150608-MF	15.5	12.7	6.35	5.16	0.8					●	▲	●										

Turning Insert (Negative) DN□□

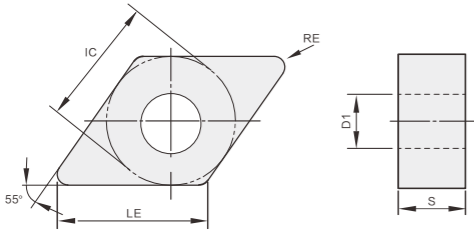

Insert Shape	Type	Dimension					P					M				K			S			
		LE	IC	S	D1	RE	OC2115	OC2125	OC2325	OC2325S	OC2425	OP1215	OP1315	OP1415	OC4315	OC3210	OC3215	OC3220	OP1105	OP6115	OP6215	
	DNMG150404-OKM	15.5	12.7	4.76	5.16	0.4												▲	▲			
	DNMG150408-OKM	15.5	12.7	4.76	5.16	0.8												▲	▲			
	DNMG150604-OKM	15.5	12.7	6.35	5.16	0.4												▲	▲			
	DNMG150608-OKM	15.5	12.7	6.35	5.16	0.8												▲	▲			
	DNMG150612-OKM	15.5	12.7	6.35	5.16	1.2												▲	▲			
	DNMG150608-OSM	15.5	12.7	6.35	5.16	0.8														●		
	DNMG150408-OPR	15.5	12.7	4.76	5.16	0.8	●	●	▲													
	DNMG150412-OPR	15.5	12.7	4.76	5.16	1.2	●	●	▲													
	DNMG150608-OPR	15.5	12.7	6.35	5.16	0.8	●	●	▲													
	DNMG150612-OPR	15.5	12.7	6.35	5.16	1.2	●	●	▲													
	DNMG150616-OPR	15.5	12.7	6.35	5.16	1.6	●	●	▲													
	DNMG150408-OKR	15.5	12.7	4.76	5.16	0.8											▲	▲				
	DNMG150412-OKR	15.5	12.7	4.76	5.16	1.2											▲	▲				
	DNMG150608-OKR	15.5	12.7	6.35	5.16	0.8											▲	▲				
	DNMG150612-OKR	15.5	12.7	6.35	5.16	1.2											▲	▲				
	DNMG110408	11.6	9.525	4.76	3.81	0.8	●	●	▲									▲				
	DNMG150404	15.5	12.7	4.76	5.16	0.4	●	●	▲									▲				
	DNMG150408	15.5	12.7	6.35	5.16	0.8	●	●	▲									▲				
	DNMG150412	15.5	12.7	6.35	5.16	1.2	●	●	▲									▲				
	DNMG150608	15.5	12.7	6.35	5.16	0.8	●	●	▲									▲				
DNMG150612	15.5	12.7	6.35	5.16	1.2	●	●	▲									▲					
	DNMA150404	15.5	12.7	4.76	5.16	0.4												▲				
	DNMA150408	15.5	12.7	4.76	5.16	0.8												▲				
	DNMA150604	15.5	12.7	6.35	5.16	0.4												▲				
	DNMA150608	15.5	12.7	6.35	5.16	0.8												▲				
	DNMA150612	15.5	12.7	6.35	5.16	1.2												▲				

Turning Insert (Negative) SN□□

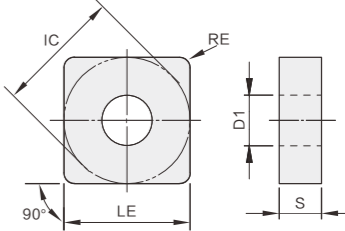

Insert Shape	Type	Dimension					P					M				K			S			
		LE	IC	S	D1	RE	OC2115	OC2125	OC2325	OC2325S	OC2425	OP1215	OP1315	OP1415	OC4315	OC3210	OC3215	OC3220	OP1105	OP6115	OP6215	
	SNMG120404-OPF	12.7	12.7	4.76	5.16	0.4	●	●	▲													
	SNMG120408-OPF	12.7	12.7	4.76	5.16	0.8	●	●	▲													
	SNMG120408-OMF	12.7	12.7	4.76	5.16	0.8												●	▲	●		
	SNMG120404-OPM	12.7	12.7	4.76	5.16	0.4	●		▲													
	SNMG120408-OPM	12.7	12.7	4.76	5.16	0.8	●		▲													
	SNMG120412-OPM	12.7	12.7	4.76	5.16	1.2	●		▲													
	SNMG150608-OPM	15.875	15.875	6.35	6.35	0.8	●		▲													
	SNMG150612-OPM	15.875	15.875	6.35	6.35	1.2	●		▲													
	SNMG120404-OMM	12.7	12.7	4.76	5.16	0.4												●	▲	●		
	SNMG120408-OMM	12.7	12.7	4.76	5.16	0.8												●	▲	●		
	SNMG120412-OMM	12.7	12.7	4.76	5.16	1.2												●	▲	●		
	SNMG150608-OMM	15.875	15.875	6.35	6.35	0.8												●	▲	●		
	SNMG120408-MF	12.7	12.7	4.76	5.16	0.8												●	▲	●		

▲ Featured grade ● Optional grade

Turning Insert (Negative) SN□□

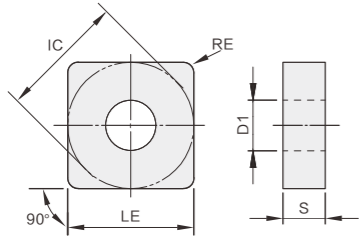

Insert Shape	Type	Dimension					P					M			K		S						
		LE	IC	S	D1	RE	OC2115	OC2125	OC2325	OC2325S	OC2425	OP1215	OP1315	OP1415	OC4315	OC3210	OC3215	OC3220	OP1105	OP6115	OP6215		
	SNMG120404-OKM	12.7	12.7	4.76	5.16	0.4											▲	▲					
	SNMG120408-OKM	12.7	12.7	4.76	5.16	0.8											▲	▲					
	SNMG120412-OKM	12.7	12.7	4.76	5.16	1.2											▲	▲					
	SNMG120408-OSM	12.7	12.7	4.76	5.16	0.8															●		
	SNMG120408-SMM	12.7	12.7	4.76	5.16	0.8											▲	▲					
	SNMG120408-OPR	12.7	12.7	4.76	5.16	0.8	●	●	▲														
	SNMG120412-OPR	12.7	12.7	4.76	5.16	1.2	●	●	▲														
	SNMG150608-OPR	15.875	15.875	6.35	6.35	0.8	●	●	▲														
	SNMG150612-OPR	15.875	15.875	6.35	6.35	1.2	●	●	▲														
	SNMG150616-OPR	15.875	15.875	6.35	6.35	1.6	●	●	▲														
	SNMG190612-OPR	19.05	19.05	6.35	7.94	1.2	●	●	▲														
	SNMG190616-OPR	19.05	19.05	6.35	7.94	1.6	●	●	▲														
	SNMM190624-OPR	19.05	19.05	6.35	7.94	2.4	●	●	▲														
	SNMG120408-OKR	12.7	12.7	4.76	5.16	0.8											▲	▲					
	SNMG120412-OKR	12.7	12.7	4.76	5.16	1.2											▲	▲					
	SNMG120416-OKR	12.7	12.7	4.76	5.16	1.6											▲	▲					
	SNMG150616-OKR	15.875	15.875	6.35	6.35	1.6											▲	▲					
	SNMG190612-OKR	19.05	19.05	6.35	7.94	1.2											▲	▲					

Turning Insert (Negative) SN□□

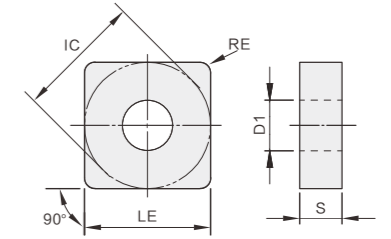

Insert Shape	Type	Dimension					P					M			K		S					
		LE	IC	S	D1	RE	OC2115	OC2125	OC2325	OC2325S	OC2425	OP1215	OP1315	OP1415	OC4315	OC3210	OC3215	OC3220	OP1105	OP6115	OP6215	
	SNMM250724-PR	25.4	25.4	9.525	9.12	2.4					▲											
	SNMM250924-PR	25.4	25.4	9.525	9.12	2.4					▲											
	SNMG120404	12.7	12.7	4.76	5.16	0.4	●	●	▲									▲				
	SNMG120408	12.7	12.7	4.76	5.16	0.8	●	●	▲									▲				
	SNMG120412	12.7	12.7	4.76	5.16	1.2	●	●	▲									▲				
	SNMG120416	12.7	12.7	4.76	5.16	1.6	●	●	▲									▲				
	SNMG150608	15.875	15.875	6.35	6.35	0.8	●	●	▲									▲				
	SNMG150612	15.875	15.875	6.35	6.35	1.2	●	●	▲									▲				
	SNMG190612	19.05	19.05	6.35	7.94	1.2	●	●	▲									▲				
	SNMG190616	19.05	19.05	6.35	7.94	1.6	●	●	▲									▲				
	SNMG250724	25.4	25.4	7.94	9.12	2.4	●	●	▲									▲				
	SNMG250924	25.4	25.4	9.525	9.12	2.4	●	●	▲									▲				
	SNMA120408	12.7	12.7	4.76	5.16	0.8												▲				
	SNMA120412	12.7	12.7	4.76	5.16	1.2												▲				
	SNMA120416	12.7	12.7	4.76	5.16	1.6												▲				

▲ 主推牌号 ● 可选牌号 ▲ Featured grade ● Optional grade

Turning Insert (Negative) TN□□

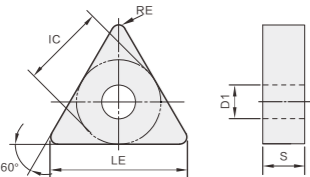

Insert Shape	Type	Dimension					P					M			K		S					
		LE	IC	S	D1	RE	OC2115	OC2125	OC2325	OC2325S	OC2425	OP1215	OP1315	OP1415	OC4315	OC3210	OC3215	OC3220	OP1105	OP6115	OP6215	
	TNMG160404-OPF	16.5	9.525	4.76	3.81	0.4	●	●	▲													
	TNMG160408-OPF	16.5	9.525	4.76	3.81	0.8	●	●	▲													
	TNMG160404-OMF	16.5	9.525	4.76	3.81	0.4					●	▲	●									
	TNMG160408-OMF	16.5	9.525	4.76	3.81	0.8					●	▲	●									
	TNMG160404-MSF	16.5	9.525	4.76	3.81	0.4					●	▲	●									
	TNMG160408-MSF	16.5	9.525	4.76	3.81	0.8					●	▲	●									

Finishing

Turning Insert (Negative) TN□□

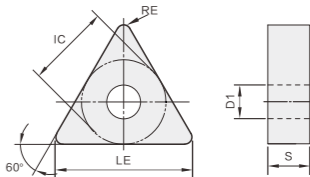

Insert Shape	Type	Dimension					P					M			K		S					
		LE	IC	S	D1	RE	OC2115	OC2125	OC2325	OC2325S	OC2425	OP1215	OP1315	OP1415	OC4315	OC3210	OC3215	OC3220	OP1105	OP6115	OP6215	
	TNMG160404-OPM	16.5	9.525	4.76	3.81	0.4	●		▲													
	TNMG160408-OPM	16.5	9.525	4.76	3.81	0.8	●		▲													
	TNMG160412-OPM	16.5	9.525	4.76	3.81	1.2	●		▲													
	TNMG220404-OPM	22	12.7	4.76	5.16	0.4	●		▲													
	TNMG220408-OPM	22	12.7	4.76	5.16	0.8	●		▲													
	TNMG220412-OPM	22	12.7	4.76	5.16	1.2	●		▲													
	TNMG220416-OPM	22	12.7	4.76	5.16	1.6	●		▲													
	TNMG160404-OMM	16.5	9.525	4.76	3.81	0.4					●	▲	●									
	TNMG160408-OMM	16.5	9.525	4.76	3.81	0.8					●	▲	●									
	TNMG220404-OMM	22	12.7	4.76	5.16	0.4					●	▲	●									
	TNMG220408-OMM	22	12.7	4.76	5.16	0.8					●	▲	●									
	TNMG220412-OMM	22	12.7	4.76	5.16	1.2					●	▲	●									
	TNMG160404-MF	16.5	9.525	4.76	3.81	0.4					●	▲	●									
	TNMG160408-MF	16.5	9.525	4.76	3.81	0.8					●	▲	●									
	TNMG160412-MF	16.5	9.525	4.76	3.81	1.2					●	▲	●									
	TNMG220404-MF	22	12.7	4.76	5.16	0.4					●	▲	●									
	TNMG220408-MF	22	12.7	4.76	5.16	0.8					●	▲	●									
	TNMG220412-MF	22	12.7	4.76	5.16	1.2					●	▲	●									
	TNMG160404-OKM	16.5	9.525	4.76	3.81	0.4												▲	▲			
	TNMG160408-OKM	16.5	9.525	4.76	3.81	0.8												▲	▲			
	TNMG160412-OKM	16.5	9.525	4.76	3.81	1.2												▲	▲			
	TNMG160408-SMM	16.5	9.525	4.76	3.81	0.8															▲	▲

Semi Finishing

▲Featured grade ●Optional grade

Turning Insert (Negative) TN□□

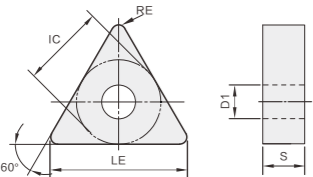

Insert Shape	Type	Dimension					P					M			K		S					
		LE	IC	S	D1	RE	OC2115	OC2125	OC2325	OC2325S	OC2425	OP1215	OP1315	OP1415	OC4315	OC3210	OC3215	OC3220	OP1105	OP6115	OP6215	
	TNMG160408-OPR	16.5	9.525	4.76	3.81	0.8	●	●	▲													
	TNMG160412-OPR	16.5	9.525	4.76	3.81	1.2	●	●	▲													
	TNMG220408-OPR	22	12.7	4.76	5.16	0.8	●	●	▲													
	TNMG220412-OPR	22	12.7	4.76	5.16	1.2	●	●	▲													
	TNMG220416-OPR	22	12.7	4.76	5.16	1.6	●	●	▲													
	TNMG270612-OPR	27.5	15.875	6.35	6.35	1.2	●	●	▲													
	TNMG160408-OMR	16.5	9.525	4.76	3.81	0.8					●	▲	●									
	TNMG160408-OKR	16.5	9.525	4.76	3.81	0.8									▲	▲						
	TNMG160412-OKR	16.5	9.525	4.76	3.81	1.2									▲	▲						

Turning Insert (Negative) TN□□

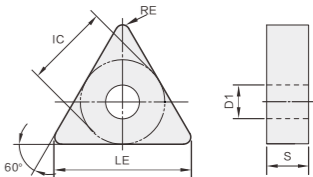

Insert Shape	Type	Dimension					P					M			K		S					
		LE	IC	S	D1	RE	OC2115	OC2125	OC2325	OC2325S	OC2425	OP1215	OP1315	OP1415	OC4315	OC3210	OC3215	OC3220	OP1105	OP6115	OP6215	
	TNMG160404	16.5	9.525	4.76	3.81	0.8	●	●	▲										▲			
	TNMG160408	16.5	9.525	4.76	3.81	1.2	●	●	▲										▲			
	TNMG160412	22	12.7	4.76	5.16	0.4	●	●	▲										▲			
	TNMG220408	22	12.7	4.76	5.16	0.8	●	●	▲										▲			
	TNMG220412	22	12.7	4.76	5.16	1.2	●	●	▲										▲			
	TNMG220416	22	12.7	4.76	5.16	1.6	●	●	▲										▲			
	TNMA160404	16.5	9.525	4.76	3.81	0.4													▲			
	TNMA160408	16.5	9.525	4.76	3.81	0.8													▲			
	TNMA160412	16.5	9.525	4.76	3.81	1.2													▲			
	TNMA220408	22	12.7	4.76	5.16	0.8													▲			
	TNMA220412	22	12.7	4.76	5.16	1.2													▲			

▲ Featured grade ● Optional grade

Turning Insert (Negative) VN□□

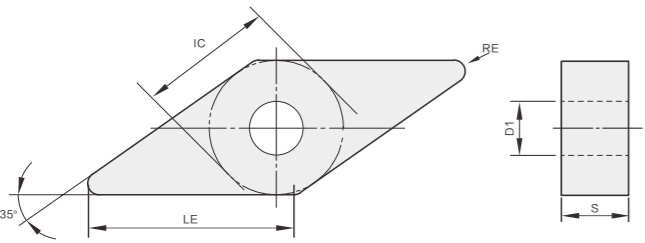

Insert Shape	Type	Dimension					P					M			K		S					
		LE	IC	S	D1	RE	OC2115	OC2125	OC2325	OC2325S	OC2425	OP1215	OP1315	OP1415	OC4315	OC3210	OC3215	OC3220	OP1105	OP6115	OP6215	
	VNMG160404-OPF	16.6	9.525	4.76	3.81	0.4	●	●	▲													
	VNMG160408-OPF	16.6	9.525	4.76	3.81	0.8	●	●	▲													
	VNMG160404-MSF	16.6	9.525	4.76	3.81	0.4					●	▲	●									
	VNMG160404-OPM	16.6	9.525	4.76	3.81	0.4	●		▲													
	VNMG160408-OPM	16.6	9.525	4.76	3.81	0.8	●		▲													
	VNMG160412-OPM	16.6	9.525	4.76	3.81	1.2	●		▲													
	VNMG160404-OMM	16.6	9.525	4.76	3.81	0.4					●	▲	●									
	VNMG160408-OMM	16.6	9.525	4.76	3.81	0.8					●	▲	●									
	VNMG160408-MF	16.6	9.525	4.76	3.81	0.8					●	▲	●									

Turning Insert (Negative) VN□□

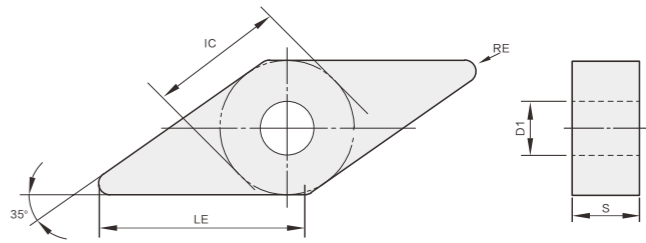

Insert Shape	Type	Dimension					P					M			K		S						
		LE	IC	S	D1	RE	OC2115	OC2125	OC2325	OC2325S	OC2425	OP1215	OP1315	OP1415	OC4315	OC3210	OC3215	OC3220	OP1105	OP6115	OP6215		
	VNMG160404-OKM	16.6	9.525	4.76	3.81	0.4														▲	▲		
	VNMG160408-OKM																				▲	▲	
	VNMG160408-SMM	16.6	9.525	4.76	3.81	0.8																▲	▲

▲ Featured grade ● Optional grade

Turning Insert (Negative) VN□□

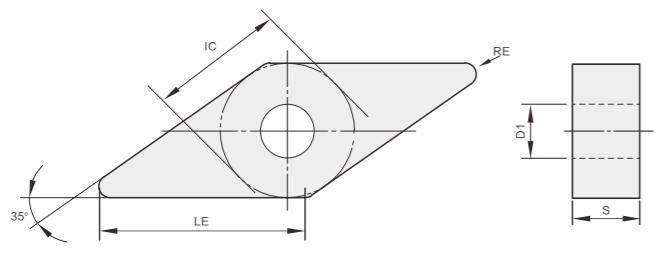

Insert Shape	Type	Dimension					P					M			K		S					
		LE	IC	S	D1	RE	OC2115	OC2125	OC2325	OC2325S	OC2425	OP1215	OP1315	OP1415	OC4315	OC3210	OC3215	OC3220	OP1105	OP6115	OP6215	
	VNMG160408-OPR	16.6	9.525	4.76	3.81	0.4	●	●	▲													
	VNMG160412-OPR	16.6	9.525	4.76	3.81	0.8	●	●	▲													
	VNMG160408-OKR	16.6	9.525	4.76	3.81	0.4									▲		▲					
	VNMG160412-OKR	16.6	9.525	4.76	3.81	0.8									▲		▲					
	VNMG160404	16.6	9.525	4.76	3.81	0.4	●	●	▲								▲					
	VNMG160408	16.6	9.525	4.76	3.81	0.8	●	●	▲								▲					
	VNMG160412	16.6	9.525	4.76	3.81	1.2	●	●	▲								▲					
	VNMA160408	16.6	9.525	4.76	3.81	0.8											▲					

Turning Insert (Negative) WN□□

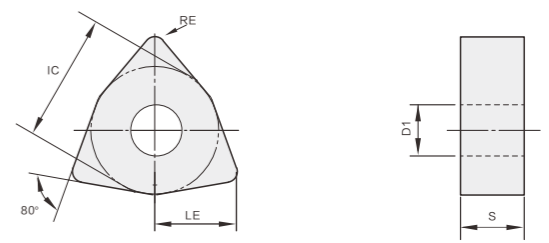

Insert Shape	Type	Dimension					P					M			K		S					
		LE	IC	S	D1	RE	OC2115	OC2125	OC2325	OC2325S	OC2425	OP1215	OP1315	OP1415	OC4315	OC3210	OC3215	OC3220	OP1105	OP6115	OP6215	
	WNMG060404-OPF	6.5	9.525	4.76	3.81	0.4	●	●	▲													
	WNMG060408-OPF	6.5	9.525	4.76	3.81	0.8	●	●	▲													
	WNMG060408-OMF	6.5	9.525	4.76	3.81	0.8						●	▲	●								
	WNMG080404-OMF	8.7	12.7	4.76	5.16	0.4						●	▲	●								
	WNMG080408-OMF	8.7	12.7	4.76	5.16	0.8						●	▲	●								
	WNMG060304-MSF	6.5	9.525	3.18	3.81	0.4						●	▲	●								
	WNMG060404-MSF	6.5	9.525	4.76	3.81	0.4						●	▲	●								
	WNMG080404-MSF	8.7	12.7	4.76	5.16	0.4						●	▲	●								
	WNMG060408-OPM	6.5	9.525	4.76	3.81	0.8	●		▲													
	WNMG080404-OPM	8.7	12.7	4.76	5.16	0.4	●		▲													
	WNMG080408-OPM	8.7	12.7	4.76	5.16	0.8	●		▲													
	WNMG080412-OPM	8.7	12.7	4.76	5.16	1.2	●		▲													
	WNMG060408-OMM	6.5	9.525	4.76	3.81	0.8						●	▲	●								
	WNMG060412-OMM	6.5	9.525	4.76	3.81	1.2						●	▲	●								
	WNMG080404-OMM	8.7	12.7	4.76	5.16	0.4						●	▲	●								
	WNMG080408-OMM	8.7	12.7	4.76	5.16	0.8						●	▲	●								
	WNMG060408-MF	6.5	9.525	4.76	3.81	0.8						●	▲	●								
	WNMG080408-MF	8.7	12.7	4.76	5.16	0.8						●	▲	●								
	WNMG080412-MF	8.7	12.7	4.76	5.16	1.2						●	▲	●								

▲ Featured grade ● Optional grade

Turning Insert (Negative) WN□□

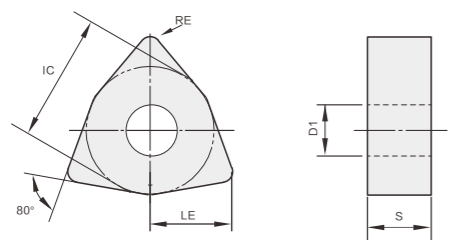

Insert Shape	Type	Dimension					P					M			K		S					
		LE	IC	S	D1	RE	OC2115	OC2125	OC2325	OC2325S	OC2425	OP1215	OP1315	OP1415	OC4315	OC3210	OC3215	OC3220	OP1105	OP6115	OP6215	
	WNMG080404-OKM	8.7	12.7	4.76	5.16	0.4										▲	▲					
	WNMG080408-OKM	8.7	12.7	4.76	5.16	0.8										▲	▲					
	WNMG080412-OKM	8.7	12.7	4.76	5.16	1.2										▲	▲					
	WNMG080408-SMM	8.7	12.7	4.76	5.16	0.8												▲			▲	
	WNMG080408-OPR	8.7	12.7	4.76	5.16	0.8	●	●	▲													
	WNMG080412-OPR	8.7	12.7	4.76	5.16	1.2	●	●	▲													
	WNMG080408-OMR	8.7	12.7	4.76	5.16	0.8					●	▲	●									
	WNMG080412-OMR	8.7	12.7	4.76	5.16	1.2					●	▲	●									
	WNMG080408-OKR	8.7	12.7	4.76	5.16	0.8										▲	▲					
	WNMG080412-OKR	8.7	12.7	4.76	5.16	1.2										▲	▲					
	WNMG080404	8.7	12.7	4.76	5.16	0.4	●	●	▲							▲						
	WNMG080408	8.7	12.7	4.76	5.16	0.8	●	●	▲							▲						
	WNMG080412	8.7	12.7	4.76	5.16	1.2	●	●	▲							▲						
	WNMA080408	8.7	12.7	4.76	5.16	0.8										▲						
	WNMA080412	8.7	12.7	4.76	5.16	1.2										▲						

Turning Insert (Positive) CC□□

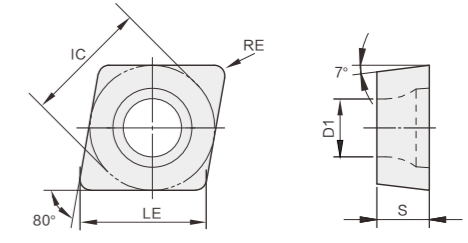

Insert Shape	Type	Dimension					P					M			K		S					
		LE	IC	S	D1	RE	OC2115	OC2125	OC2325	OC2325S	OC2425	OP1215	OP1315	OP1415	OC4315	OC3210	OC3215	OC3220	OP1105	OP6115	OP6215	
	CCMT060202-OTF	6.4	6.35	2.38	2.8	0.2	▲					●	▲	●								
	CCMT060204-OTF	6.4	6.35	2.38	2.8	0.4	▲					●	▲	●								
	CCMT09T304-OTF	9.7	9.525	3.97	4.4	0.4	▲					●	▲	●								
	CCMT09T308-OTF	9.7	9.525	3.97	4.4	0.8	▲					●	▲	●								
	CCMT120404-OTF	12.9	12.7	4.76	5.5	0.4	▲					●	▲	●								
	CCMT120408-OTF	12.9	12.7	4.76	5.5	0.8	▲					●	▲	●								
	CCMT060202-MSF	6.4	6.35	2.38	2.8	0.2						●	▲	●								
	CCMT060204-MSF	6.4	6.35	2.38	2.8	0.4						●	▲	●								
	CCMT09T302-MSF	9.7	9.525	3.97	4.4	0.2						●	▲	●								
	CCMT09T304-MSF	9.7	9.525	3.97	4.4	0.4						●	▲	●								
	CCMT09T308-MSF	12.9	12.7	4.76	5.5	0.8						●	▲	●								
	CCMT120404-MSF	12.9	12.7	4.76	5.5	0.4						●	▲	●								
	CCMT060204-OTM	6.4	6.35	2.38	2.8	0.4	●	●	▲			●	▲	●								
	CCMT060208-OTM	6.4	6.35	2.38	2.8	0.8	●	●	▲			●	▲	●								
	CCMT09T304-OTM	9.7	9.525	3.97	4.4	0.4	●	●	▲			●	▲	●								
	CCMT09T308-OTM	9.7	9.525	3.97	4.4	0.8	●	●	▲			●	▲	●								
	CCMT120404-OTM	12.9	12.7	4.76	5.5	0.4	●	●	▲			●	▲	●								
	CCMT120408-OTM	12.9	12.7	4.76	5.5	0.8	●	●	▲			●	▲	●								
	CCMT060208-OTR	6.4	6.35	2.38	2.8	0.8	●	●	▲									▲				
	CCMT09T304-OTR	9.7	9.525	3.97	4.4	0.4	●	●	▲									▲				
	CCMT09T308-OTR	9.7	9.525	3.97	4.4	0.8	●	●	▲									▲				
	CCMT120408-OTR	12.9	12.7	4.76	5.5	0.8	●	●	▲									▲				

▲ Featured grade ● Optional grade

Turning Insert (Positive) DC□□

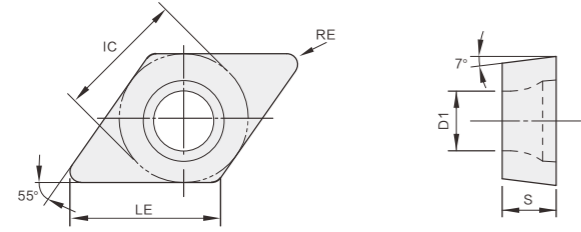

Insert Shape	Type	Dimension					P					M			K		S						
		LE	IC	S	D1	RE	OC2115	OC2125	OC2325	OC2325S	OC2425	OP1215	OP1315	OP1415	OC4315	OC3210	OC3215	OC3220	OP1105	OP6115	OP6215		
	DCMT070204-OTF	7.8	6.35	2.38	2.8	0.4	▲					●	▲	●									
	DCMT11T302-OTF	11.6	9.525	3.97	4.4	0.2	▲					●	▲	●									
	DCMT11T304-OTF	11.6	9.525	3.97	4.4	0.4	▲					●	▲	●									
	DCMT070204-MSF	7.8	6.35	2.38	2.8	0.4					●	▲	●										
	DCMT11T304-MSF	11.6	9.525	3.97	4.4	0.4					●	▲	●										
	DCMT070204-OTM	7.8	6.35	2.38	2.8	0.4	●	●	●	▲	●	▲	●										
	DCMT070208-OTM	7.8	6.35	2.38	2.8	0.8	●	●	●	▲	●	▲	●										
	DCMT11T304-OTM	11.6	9.525	3.97	4.4	0.4	●	●	●	▲	●	▲	●										
	DCMT11T308-OTM	11.6	9.525	3.97	4.4	0.8	●	●	●		●	▲	●										
	DCMT11T304-OTR	11.6	9.525	3.97	4.4	0.4	●	●	●	▲	●	▲	●										
	DCMT11T308-OTR	11.6	9.525	3.97	4.4	0.8	●	●	●	▲	●	▲	●										

Turning Insert (Positive) RC□□

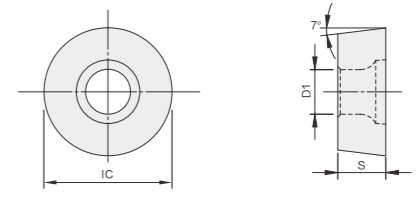

Insert Shape	Type	Dimension					P					M			K		S						
		LE	IC	S	D1	RE	OC2115	OC2125	OC2325	OC2325S	OC2425	OP1215	OP1315	OP1415	OC4315	OC3210	OC3215	OC3220	OP1105	OP6115	OP6215		
	RCMX0803MO	8.0	8.0	3.18	3.4		▲	●															
	RCMX1003MO	10	10	3.18	3.6		▲	●															
	RCMX1204MO-Q	12	12	4.76	4.4		▲	●															
	RCMX1606MO-Q	16	16	6.35	5.5		▲	●															
	RCMX2006MO-Q	20	20	6.35	6.5		▲	●															
	RCMX2507MO-Q	25	25	7.94	7.2		▲	●															
	RCMX3209MO-Q	32	32	9.52	9.5		▲	●															
	RCMT0803MO	8.0	8.0	3.18	3.4		▲	●															
	RCMT1606MO-Q	16	16	6.35	5.5		▲	●															

▲ Featured grade ● Optional grade

Turning Insert (Positive) SC□□

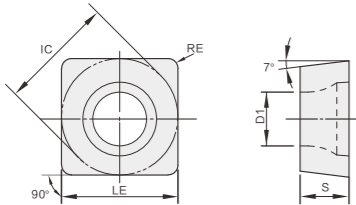

Insert Shape	Type	Dimension					P					M			K		S					
		LE	IC	S	D1	RE	OC2115	OC2125	OC2325	OC2325S	OC2425	OP1215	OP1315	OP1415	OC4315	OC3210	OC3215	OC3220	OP1105	OP6115	OP6215	
	Finishing																					
	SCMT09T304-OTF	9.525	9.525	3.97	4.4	0.4	●					●	▲	●								
	SCMT09T308-OTF	9.525	9.525	3.97	4.4	0.8	●					●	▲	●								
SCMT120404-OTF	12.7	12.7	4.76	5.5	0.4	●					●	▲	●									
	Semi Finishing																					
	SCMT09T304-OTM	9.525	9.525	3.97	4.4	0.4	●	●	●	▲		●	▲	●								
	SCMT09T308-OTM	9.525	9.525	3.97	4.4	0.8	●	●	●	▲		●	▲	●								
	SCMT120404-OTM	12.7	12.7	4.76	5.5	0.4	●	●	●	▲		●	▲	●								
	SCMT120408-OTM	12.7	12.7	4.76	5.5	0.8	●	●	●	▲		●	▲	●								
SCMT120412-OTM	12.7	12.7	4.76	5.5	1.2	●	●	●	▲		●	▲	●									
	Roughing																					
	SCMT09T304-OTR	9.525	9.525	3.97	4.4	0.4	●	●	●	▲							▲					
	SCMT09T308-OTR	9.525	9.525	3.97	4.4	0.8	●	●	●	▲							▲					
	SCMT120404-OTR	12.7	12.7	4.76	5.5	0.4	●	●	●	▲							▲					
	SCMT120408-OTR	12.7	12.7	4.76	5.5	0.8	●	●	●	▲							▲					
SCMT120412-OTR	12.7	12.7	4.76	5.5	1.2	●	●	●	▲							▲						

Turning Insert (Positive) TC□□

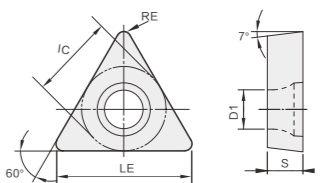

Insert Shape	Type	Dimension					P					M			K		S					
		LE	IC	S	D1	RE	OC2115	OC2125	OC2325	OC2325S	OC2425	OP1215	OP1315	OP1415	OC4315	OC3210	OC3215	OC3220	OP1105	OP6115	OP6215	
	Finishing																					
	TCMT110202-OTF	11	6.35	2.38	2.8	0.2	▲					●	▲	●								
	TCMT110204-OTF	11	6.35	2.38	2.8	0.4	▲					●	▲	●								
	TCMT16T304-OTF	16.5	9.525	3.97	4.4	0.4	▲					●	▲	●								
	TCMT16T308-OTF	16.5	9.525	3.97	4.4	0.8	▲					●	▲	●								
	Semi Finishing																					
	TCMT090204-OTM	9.6	5.56	2.38	2.5	0.4	●	●	●	▲		●	▲	●								
	TCMT090208-OTM	9.6	5.56	2.38	2.5	0.8	●	●	●	▲		●	▲	●								
	TCMT110204-OTM	11	6.35	2.38	2.8	0.4	●	●	●	▲		●	▲	●								
	TCMT110208-OTM	11	6.35	2.38	2.8	0.8	●	●	●	▲		●	▲	●								
	TCMT16T304-OTM	16.5	9.525	3.97	4.4	0.4	●	●	●	▲		●	▲	●								
	TCMT16T308-OTM	16.5	9.525	3.97	4.4	0.8	●	●	●	▲		●	▲	●								
TCMT16T312-OTM	16.5	9.525	3.97	4.4	1.2	●	●	●	▲		●	▲	●									
	Roughing																					
	TCMT16T308-OTR	16.5	9.525	3.97	4.4	0.8	●	●	●	▲								▲				
TCMT220408-OTR	22	12.7	4.76	5.5	0.8	●	●	●	▲									▲				

▲ Featured grade ● Optional grade

Turning Insert (Positive) VB□□

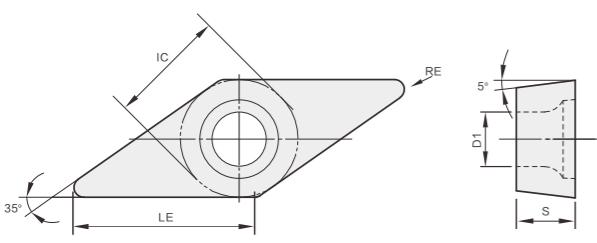

Insert Shape	Type	Dimension					P					M			K			S					
		LE	IC	S	D1	RE	OC2115	OC2125	OC2325	OC2325S	OC2425	OP1215	OP1315	OP1415	OC4315	OC3210	OC3215	OC3220	OP1105	OP6115	OP6215		
	VBMT160404-OTF	16.5	9.525	4.76	4.4	0.4	▲					●	▲	●									
	VBMT160408-OTF	16.5	9.525	4.76	4.4	0.8	▲					●	▲	●									
	VBMT110304-OTM	11	6.35	3.18	2.8	0.4	●	●	●	▲		●	▲	●									
	VBMT160404-OTM	16.5	9.525	4.76	4.4	0.4	●	●	●	▲		●	▲	●									
	VBMT160408-OTM	16.5	9.525	4.76	4.4	0.8	●	●	●	▲		●	▲	●									
	VBMT160412-OTM	16.5	9.525	4.76	4.4	1.2	●	●	●	▲		●	▲	●									
	VBMT160404-OMM	16.5	9.525	4.76	4.4	0.4						●	▲	●									
	VBMT160404-OSM	16.5	9.525	4.76	4.4	0.4														●	▲	▲	
	VBMT160408-OSM	16.5	9.525	4.76	4.4	0.8														●	▲	▲	
	VBMT160404-OTR	16.5	9.525	4.76	4.4	0.4	●	●	●	▲							▲						
	VBMT160408-OTR	16.5	9.525	4.76	4.4	0.8	●	●	●	▲							▲						

Turning Insert (Positive) VC□□

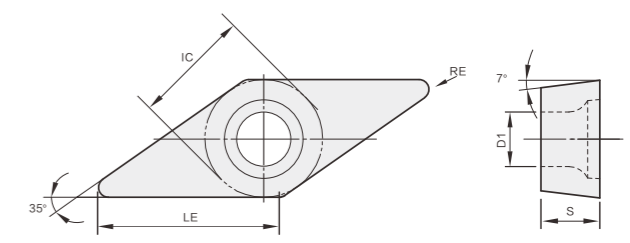

Insert Shape	Type	Dimension					P					M			K			S					
		LE	IC	S	D1	RE	OC2115	OC2125	OC2325	OC2325S	OC2425	OP1215	OP1315	OP1415	OC4315	OC3210	OC3215	OC3220	OP1105	OP6115	OP6215		
	VCMT110302-OTF	11	6.35	3.18	2.8	0.2	▲					●	▲	●									
	VCMT110304-OTF	11	6.35	3.18	2.8	0.4	▲					●	▲	●									
	VCMT160404-OTF	16.5	9.525	4.76	4.4	0.4	▲					●	▲	●									
	VCMT160404-OTM	16.5	9.525	4.76	4.4	0.4	▲					●	▲	●									
	VCMT160408-OTM	16.5	9.525	4.76	4.4	0.8	▲					●	▲	●									
	VCMT160408-OSM	16.5	9.525	4.76	4.4	0.8															●	▲	▲

▲Featured grade ●Optional grade

Turning Insert (Positive) TB□□ TP□□

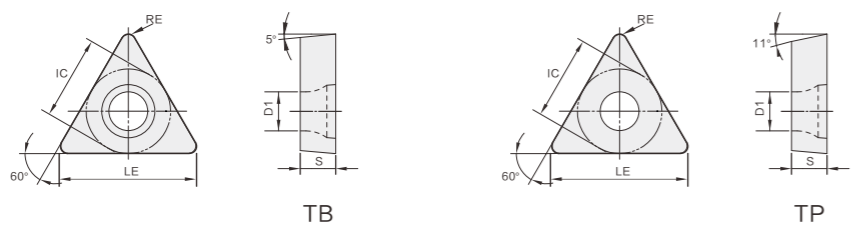

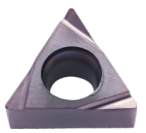
Insert Shape	Type	Dimension					P					M			K		S						
		LE	IC	S	D1	RE	OC2115	OC2125	OC2325	OC2325S	OC2425	OP1205H	OP1215	OP1315	OP1415	OC4315	OC3210	OC3215	OC3220	OP1105	OP6115	OP6215	
	TBGH060202L	6.4	3.97	2.38	2.3	0.2						▲											
	TPGH080202L	8.2	4.76	2.38	2.4	0.2						▲											
	TPGH080204L	8.2	4.76	2.38	2.4	0.4						▲											
	TPGH090202L	9.6	5.56	2.38	2.8	0.2						▲											
	TPGH090204L	9.6	5.56	2.38	2.8	0.4						▲											
	TPGH110302L	11	6.35	3.18	3.18	0.2						▲											
	TPGH110304L	11	6.35	3.18	3.18	0.4						▲											

Turning Insert (Positive) KN□□

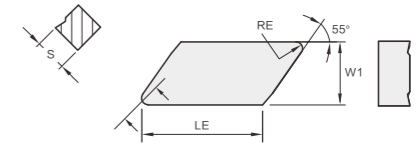

Insert Shape	Type	Dimension					P					M			K		S					
		LE	W1	S	D1	RE	OC2115	OC2125	OC2325	OC2325S	OC2425	OP1215	OP1315	OP1415	OC4315	OC3210	OC3215	OC3220	OP1105	OP6115	OP6215	
	KNUX160405L11	16.2	9.525	4.76	2.2	0.5	▲	●														
	KNUX160405R11	16.2	9.525	4.76	2.2	0.5	▲	●														

▲Featured grade ●Optional grade

Train Wheel Hub Machining

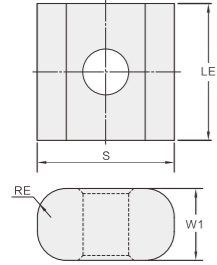

Insert Shape	Type	Dimension					P					M				K		
		LE	W1	S	D1	RE	OC2115	OC2125	OC2325	OC2325S	OC2425	OP1215	OP1315	OP1415	OC4315	OC3210	OC3215	OC3220
	175.32-191940-22	19.1	10	19.1	6.35	4.0				▲								
	175.32-191940-28	19.1	10	19.1	6.35	4.0				▲								

Heavy Duty Machining

Insert for Aluminum Cutting CC□□ DC□□ RC□□

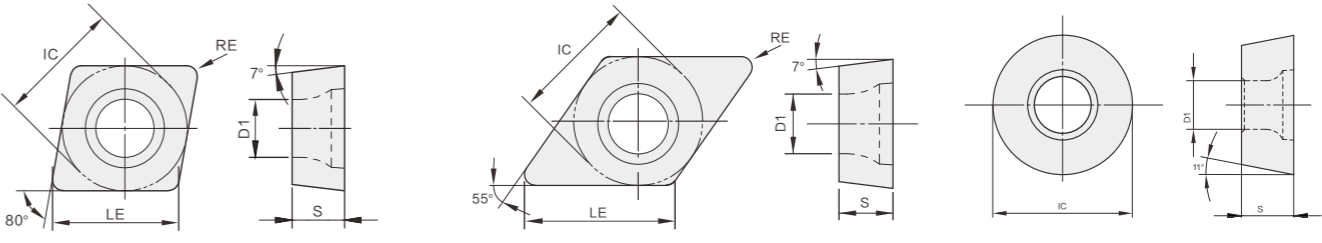

Insert Shape	Type	Dimension					N
		LE	IC	S	D1	RE	
	CCGX060202-NL	6.4	6.35	2.38	2.8	0.2	▲
	CCGX060204-NL	6.4	6.35	2.38	2.8	0.4	▲
	CCGX09T302-NL	9.7	9.525	3.97	4.4	0.2	▲
	CCGX09T304-NL	9.7	9.525	3.97	4.4	0.4	▲
	CCGX09T308-NL	9.7	9.525	3.97	4.4	0.8	▲
	CCGX120404-NL	12.9	12.7	4.76	5.5	0.4	▲
	CCGX120408-NL	12.9	12.7	4.76	5.5	0.8	▲
	DCGX070202-NL	7.8	6.35	2.38	2.8	0.2	▲
	DCGX070204-NL	7.8	6.35	2.38	2.8	0.4	▲
	DCGX11T302-NL	11.6	9.525	3.97	4.4	0.2	▲
	DCGX11T304-NL	11.6	9.525	3.97	4.4	0.4	▲
	DCGX11T308-NL	11.6	9.525	3.97	4.4	0.8	▲
	RCGT1204MO-NL	12	12	4.76	4.4	/	▲

Finishing

▲Featured grade ●Optional grade

Insert for Aluminum Cutting

SC□□ TC□□ VC□□

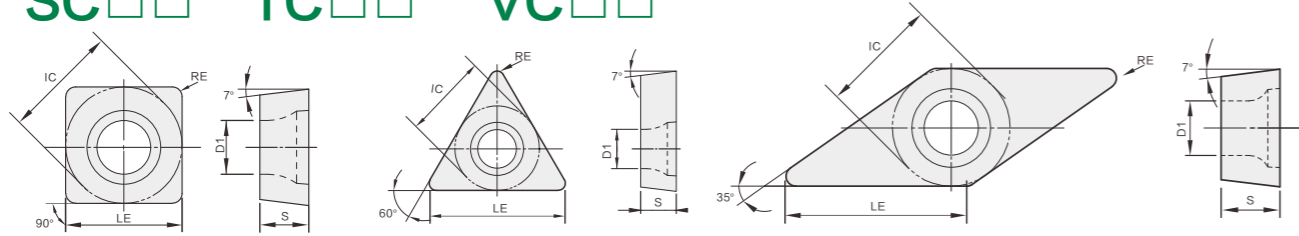

Insert Shape	Type	Dimension					N
		LE	IC	S	D1	RE	
	SCGX09T304-NL	9.525	9.525	3.97	4.4	0.4	▲
	SCGX09T308-NL	9.525	9.525	3.97	4.4	0.8	▲
	SCGX120408-NL	12.7	12.7	4.76	5.5	0.8	▲
	TCGX090204-NL	9.6	5.56	2.38	2.5	0.4	▲
	TCGX110202-NL	11	6.35	2.38	2.8	0.2	▲
	TCGX110204-NL	11	6.35	2.38	2.8	0.4	▲
	TCGX16T304-NL	16.5	9.525	3.97	4.4	0.4	▲
	TCGX16T308-NL	16.5	9.525	3.97	4.4	0.8	▲
	VCGX110302-NL	11	6.35	3.18	2.8	0.2	▲
	VCGX110304-NL	11	6.35	3.18	2.8	0.4	▲
	VCGX160402-NL	16.5	9.525	4.76	4.4	0.2	▲
	VCGX160404-NL	16.5	9.525	4.76	4.4	0.4	▲
	VCGX160408-NL	16.5	9.525	4.76	4.4	0.8	▲
	VCGX160412-NL	16.5	9.525	4.76	4.4	1.2	▲
	VCGX220530-NL	22	12.7	5.56	5.5	3	▲

Cermet Inserts

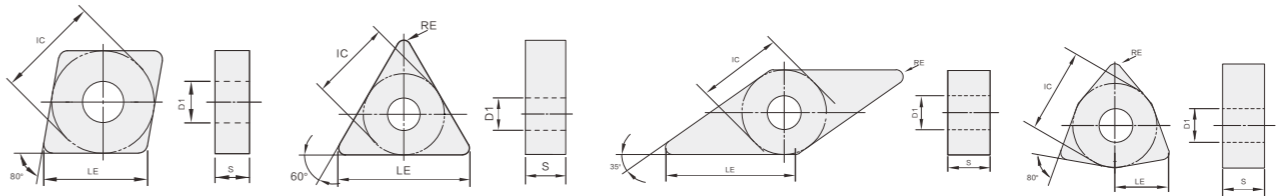

Insert Shape	Type	Dimension					Grade	
		LE	IC	S	D1	RE	OKE6220	OKE6210
	CNMG120408-SAL	12.9	12.9	4.76	5.16	0.8	▲	▲
	TNMG160404-SAL	16.5	9.525	4.76	3.81	0.4	▲	▲
	TNMG160408-SAL	16.5	9.525	4.76	3.81	0.8	▲	▲
	VNMG160408-SAL	16.6	9.525	4.76	3.81	0.8	▲	▲
	WNMG080404-SAL	8.7	12.7	4.76	5.16	0.4	▲	▲
	WNMG080408-SAL	8.7	12.7	4.76	5.16	0.8	▲	▲

Parting and Grooving Insert Naming Rule

Application Code

QC H V 03 02 R 05 —MP

Symbol	Application Code
QC	Grooving
QD	Part off
QR	Profile
QT	Parting & Grooving

Tools Holder Type

QC H V 03 02 R 05 —MP

Symbol	Width (mm)	Handle.
E	2	E
F	2.5	F E
G	3	G F E
H	4	H
J	5	J H
K	6	K J H
L	8	L

Corner Radius

QC H V 03 02 R 05 —MP

Symbol	Corner Radius
02	R0.2
03	R0.3
04	R0.4
05	R0.5
08	R0.8

Cutting Direction

QC H V 03 02 R 05 —MP

Symbol	Width (mm)
R	Right
L	Left
N	Neutral

Parting and Grooving Insert Naming Rule

Edge Number

QC H V 03 02 R 05 —MP

Symbol	Edge Number
W/D	2
V/S	1

Cutting Edge Width

QT H D 05 04 N —MG

Symbol	Width (mm)
05	5
06	6

Insert Angle

QC H V 03 02 R 05 —MP

Symbol	Angle
05	5°
07	7°

Chip Breaker

QC H V 03 02 R 05 —MG

MG	OC
	

Parting and Grooving Insert QT□□

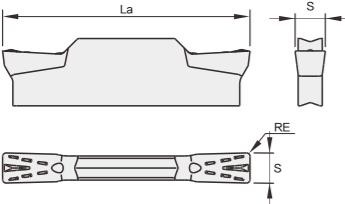

Insert Shape	Type	Dimension			Grade	
		S ₀ ^{+0.1}	RE	La _{MAX}	OC4020	OP1215
	QTED02503N-MG	2.5	0.3	20.5	●	●
	QTFD0303N-MG	3	0.3	20.5	●	●
	QTGD0404N-MG	4	0.4	25.5	●	●
	QTHD0504N-MG	5	0.4	25.5	●	●
	QTKD0608N-MG	6	0.8	25.5	●	●

Parting and Grooving Insert QT□□

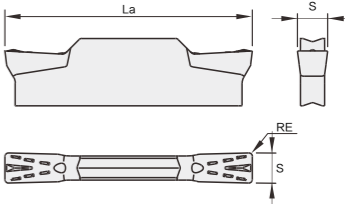

Insert Shape	Type	Dimension			Grade	
		S ₀ ^{+0.1}	RE	La _{MAX}	OC4020	OP1215
	QCFW0202N-OC	2	0.2	16	●	●
	QCFW02502N-OC	2.5	0.2	18.5	●	●
	QCGW0304N-OC	3	0.4	21	●	●
	QCHW0404N-OC	4	0.4	21	●	●
	QCJW0508N-OC	5	0.8	26	●	●

▲Featured grade ●Optional grade

Threading Turning Insert Naming Rules

Cutting Direction

R/L/T 16 01 G A 60 M

RT	LT
right hand	left hand

Number of Teeth

R/L/T 16 01 G A 60 M

01	N
Single-teeth	N-teeth

Pitch Width

R/L/T 16 01 G A 60 M

	A	AG	G	N	Q		
mm	0.5-1.5	1.0-3.0	1.75-3.0	3.5-5.0	5.5-6.0		
TPI	48-16	26-10	14-8	7-5	4.5-4		

Insert Size

R/L/T 16 01 G A 60 M

L(mm)	IC(mm)	L(mm)	IC(mm)
6	3.97	16	9.525
8	4.76	22	12.7
11	6.35	27	15.875

Insert Type

R/L/T 16 01 G A 60 M

Symbol	Type
G	External threading
L	Internal threading

Threading Turning insert Naming Rules

Thread Profile

R/L/T 16 01 G A 60 M

Symbol	Thread Profile
55	55° general pitch thread
60	60° general pitch thread
ISO	ISO metric thread
UN	Unified thread (American standard thread)
W	Whitworth thread
BSPT	British standard taper pipe thread
NPT	NPT American standard taper pipe thread
UNJ	UNJ American standard aerospace and aviation thread
RD	30° DIN405 round thread
APIRD	Petroleum pipeline thread
TR	Trapeze30° 103 30° ISO metric thread
ACME	29° American standard ACME thread
STACME	29° American standard STACME thread

Production Method

R/L/T 16 01 G A 60 M

A	M
Full pressing	Fullground

Threading Insert

60° General Pitch Thread

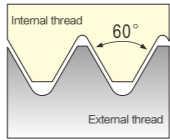
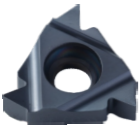

- ▶ Application for insert
 - ▶ Standard
 - ▶ Tolerance grade
- it is suitable for all machining

External thread		
Ground type	Applicative pitch	
	mm	TPI
R/LT0601G-A60M	0.5-1.25	48-16
R/LT1601G-A60M	0.5-1.5	48-16
R/LT1601G-AG60M	0.5-1.5	26-8
R/LT1601G-G60M	0.5-3.0	14-8
R/LT2201G-N60M	0.5-1.5	7-5
R/LT2701G-Q60M	0.5-3.0	4.5-4

Internal thread		
Ground type	Applicative pitch	
	mm	TPI
R/LT0601L-A60M	0.5-1.25	48-20
R/LT0801L-A60M	0.5-1.5	48-16
R/LT1101L-A60M	0.5-1.5	48-16
R/LT1101L-AG60M	1.0-2.5	26-9
R/LT1601L-A60M	0.5-1.5	48-16
R/LT1601L-AG60M	1.0-3.0	26-8
R/LT1601L-G60M	1.75-3.0	14-8
R/LT2201L-N60M	3.5-5.0	7-5
R/LT2701L-Q60-M	5.5-6.0	4.5-4

Threading Insert

55° General Pitch Thread

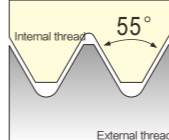
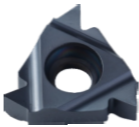

- ▶ Application for insert
 - ▶ Standard
 - ▶ Tolerance grade
- it is suitable for all machining

External thread		
Ground type	Applicative pitch	
	mm	TPI
R/LT1101G-A55M	0.5-1.5	48-16
R/LT1601G-A55M	0.5-1.5	48-16
R/LT1601G-AG55M	1.0-3.0	26-8
R/LT1601G-G55M	1.75-3.0	14-8
R/LT2201G-N55M	3.5-5.0	7-5
R/LT2701G-Q55M	5.5-6.0	4.5-4

Internal thread		
Ground type	Applicative pitch	
	mm	TPI
R/LT0601L-A55M	0.5-1.25	48-20
R/LT0801L-A55M	0.5-1.5	48-16
R/LT1101L-A55M	0.5-1.5	48-16
R/LT1101L-AG55M	1.0-2.5	26-9
R/LT1601L-A55M	0.5-1.5	48-16
R/LT1601L-AG55M	1.0-3.0	26-8
R/LT1601L-G55M	1.75-3.0	14-8
R/LT2201L-N55M	3.5-5.0	7-5
R/LT2701L-Q55M	5.5-6.0	4.5-4

Threading Insert

ISO Metric Thread

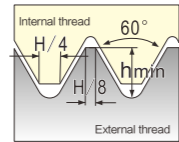
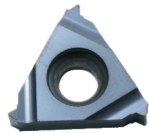

► Application for insert

It is suitable for all machining

► Standard
MR262(DIN13)

► Tolerance grade
6g/6H

External thread				Internal thread			
Ground type	A type	Applicative pitch		Ground type	A type	Applicative pitch	
		mm	TPI			mm	TPI
				R/LT0601L-050ISOM		0.5	0.29
				R/LT0601L-075ISOM		0.75	0.43
				R/LT0601L-100ISOM		1.00	0.58
				R/LT0601L-125ISOM		1.25	0.72
				R/LT0801L-050ISOM		0.5	0.29
				R/LT0801L-075ISOM		0.75	0.43
				R/LT0801L-100ISOM		1.00	0.58
				R/LT0801L-125ISOM		1.25	0.72
				R/LT0801L-150ISOM		1.50	0.87
				R/LT0801L-175ISOM		1.75	1.01
R/LT1101G-050ISOM		0.50	0.31	R/LT1101L-050ISOM		0.50	0.29
R/LT1101G-075ISOM		0.75	0.46	R/LT1101L-075ISOM		0.75	0.43
R/LT1101G-080ISOM		0.8	0.49	R/LT1101L-080ISOM		0.8	0.46
R/LT1101G-100ISOM		1.00	0.61	R/LT1101L-100ISOM		1.00	0.58
R/LT1101G-125ISOM		1.25	0.77	R/LT1101L-125ISOM		1.25	0.72
R/LT1101G-150ISOM		1.50	0.92	R/LT1101L-150ISOM		1.50	0.87
R/LT1101G-175ISOM		1.75	1.07	R/LT1101L-175ISOM		1.75	1.01
R/LT1101G-200ISOM		2.00	1.23	R/LT1101L-200ISOM		2.00	1.15
R/LT1601G-050ISOM		0.50	0.31	R/LT1601L-050ISOM		0.50	0.29
R/LT1601G-075ISOM		0.75	0.46	R/LT1601L-075ISOM		0.75	0.43
R/LT1601G-080ISOM		0.80	0.49	R/LT1601L-080ISOM		0.80	0.46
R/LT1601G-100ISOM		1.00	0.61	R/LT1601L-100ISOM		1.00	0.58
R/LT1601G-125ISOM		1.25	0.77	R/LT1601L-125ISOM		1.25	0.72
R/LT1601G-150ISOM	RT1601G-150ISOA	1.50	0.92	R/LT1601L-150ISOM	RT1601L-150ISOA	1.50	0.87
R/LT1601G-175ISOM		1.75	1.07	R/LT1601L-175ISOM		1.75	1.01
R/LT1601G-200ISOM	RT1601G-200ISOA	2.00	1.23	R/LT1601L-200ISOM	RT1601L-200ISOA	2.00	1.15
R/LT1601G-250ISOM	RT1601G-250ISOA	2.50	1.53	R/LT1601L-250ISOM	RT1601L-250ISOA	2.50	1.44
R/LT1601G-300ISOM	RT1601G-300ISOA	3.00	1.84	R/LT1601L-300ISOM	RT1601L-300ISOA	3.00	1.73
R/LT1601G-350ISOM		3.50	2.15	R/LT1601L-350ISOM		3.50	2.02
R/LT2201G-350ISOM		3.50	2.15	R/LT2201L-350ISOM		3.50	2.02
R/LT2201G-400ISOM		4.00	2.45	R/LT2201L-400ISOM		4.00	2.31
R/LT2201G-450ISOM		4.5	2.76	R/LT2201L-450ISOM		4.5	2.60
R/LT2201G-500ISOM		5.00	3.07	R/LT2201L-500ISOM		5.00	2.89
R/LT2701G-550ISOM		5.50	3.37	R/LT2701L-550ISOM		5.50	3.17
R/LT2701G-600ISOM		6.00	3.68	R/LT2701L-600ISOM		6.00	3.46

Threading Insert

Unified Thread (American Standard Thread)

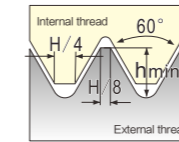
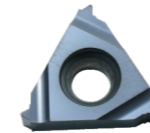

► Application for insert

It is suitable for all machining

► Standard
ANSI B1.1:74

► Tolerance grade
2A/2B

External thread			Internal thread		
Ground type	Applicative pitch		Ground type	Applicative pitch	
	mm	TPI		mm	TPI
			R/LT0601L-28UNM	28	0.52
			R/LT0601L-24UNM	24	0.61
			R/LT0601L-20UNM	20	0.73
			R/LT0601L-18UNM	18	0.81
			R/LT0801L-28UNM	28	0.52
			R/LT0801L-24UNM	24	0.61
			R/LT0801L-20UNM	20	0.73
			R/LT0801L-18UNM	18	0.81
			R/LT0801L-16UNM	16	0.92
R/LT1101G-28UNM	28	0.56	R/LT1101L-28UNM	28	0.52
R/LT1101G-24UNM	24	0.65	R/LT1101L-24UNM	24	0.61
R/LT1101G-20UNM	20	0.78	R/LT1101L-20UNM	20	0.73
R/LT1101G-18UNM	18	0.87	R/LT1101L-18UNM	18	0.81
R/LT1101G-16UNM	16	0.97	R/LT1101L-16UNM	16	0.92
R/LT1101G-14UNM	14	1.11	R/LT1101L-14UNM	14	1.05
R/LT1101G-12UNM	12	1.30	R/LT1101L-12UNM	12	1.22
R/LT1601G-48UNM	48	0.30	R/LT1601L-48UNM	48	0.31
R/LT1601G-40UNM	40	0.39	R/LT1601L-40UNM	40	0.37
R/LT1601G-32UNM	32	0.49	R/LT1601L-32UNM	32	0.46
R/LT1601G-28UNM	28	0.56	R/LT1601L-28UNM	28	0.52
R/LT1601G-24UNM	24	0.65	R/LT1601L-24UNM	24	0.61
R/LT1601G-20UNM	20	0.78	R/LT1601L-20UNM	20	0.73
R/LT1601G-18UNM	18	0.87	R/LT1601L-18UNM	18	0.81
R/LT1601G-16UNM	16	0.97	R/LT1601L-16UNM	16	0.92
R/LT1601G-14UNM	14	1.11	R/LT1601L-14UNM	14	1.05
R/LT1601G-12UNM	12	1.30	R/LT1601L-12UNM	12	1.22
R/LT1601G-11UNM	11	1.42	R/LT1601L-11UNM	11	1.28
R/LT1601G-10UNM	10	1.56	R/LT1601L-10UNM	10	1.47
R/LT1601G-9UNM	9	1.73	R/LT1601L-9UNM	9	1.63
R/LT1601G-8UNM	8	1.95	R/LT1601L-8UNM	8	1.83
R/LT2201G-7UNM	7	2.22	R/LT2201L-7UNM	7	2.09
R/LT2201G-6UNM	6	2.60	R/LT2201L-6UNM	6	2.44
R/LT2201G-5UNM	5	3.12	R/LT2201L-5UNM	5	2.93
R/LT2701G-4.5UNM	4.5	3.46	R/LT2701L-4.5UNM	4.5	3.26
R/LT2701G-4UNM	4	3.89	R/LT2701L-4UNM	4	3.67

Threading Insert

Whitworth Thread

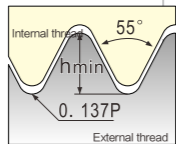
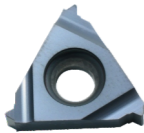

Application for insert
It is suitable for all machining

- Standard
B.S.84:1956,
DIN259,ISO228/1:1982
- Tolerance grade
Medium class A

External thread				Internal thread			
Ground type	A type	Applicative pitch		Ground type	A type	Applicative pitch	
		mm	TPI			mm	TPI
				R/LT0601L-28WM		28	0.58
				R/LT0601L-24WM		24	0.68
				R/LT0601L-20WM		20	0.51
				R/LT0601L-19WM		19	0.90
				R/LT0801L-28WM		28	0.58
				R/LT0801L-24WM		24	0.68
				R/LT0801L-20WM		20	0.81
				R/LT0801L-19WM		19	0.90
				R/LT0801L-16WM		16	1.02
R/LT1101G-28WM		28	0.58	R/LT1101L-28WM		28	0.58
R/LT1101G-24WM		24	0.68	R/LT1101L-24WM		24	0.68
R/LT1101G-20WM		20	0.81	R/LT1101L-20WM		20	0.81
R/LT1101G-19WM		19	0.90	R/LT1101L-19WM		19	0.90
R/LT1101G-16WM		16	1.02	R/LT1101L-16WM		16	1.02
R/LT1101G-14WM		14	1.16	R/LT1101L-14WM		14	1.16
R/LT1101G-11WM		11	1.48	R/LT1101L-11WM		11	1.48
R/LT1601G-48WM		48	0.34	R/LT1601L-48WM		48	0.34
R/LT1601G-40WM		40	0.41	R/LT1601L-40WM		40	0.41
R/LT1601G-32WM		32	0.51	R/LT1601L-32WM		32	0.51
R/LT1601G-28WM		28	0.58	R/LT1601L-28WM		28	0.58
R/LT1601G-26WM		26	0.63	R/LT1601L-26WM		26	0.63
R/LT1601G-24WM		24	0.68	R/LT1601L-24WM		24	0.68
R/LT1601G-20WM		20	0.81	R/LT1601L-20WM		20	0.81
R/LT1601G-19WM		19	0.90	R/LT1601L-19WM		19	0.90
R/LT1601G-16WM		16	1.02	R/LT1601L-16WM		16	1.02
R/LT1601G-14WM	RT1601G-14WA	14	1.16	R/LT1601L-14WM	RT1601L-14WA	14	1.16
R/LT1601G-12WM		12	1.36	R/LT1601L-12WM		12	1.36
R/LT1601G-11WM	RT1601G-11WA	11	1.48	R/LT1601L-11WM	RT1601L-11WA	11	1.48
R/LT1601G-10WM		10	1.63	R/LT1601L-10WM		10	1.63
R/LT1601G-9WM		9	1.81	R/LT1601L-9WM		9	1.81
R/LT1601G-8WM		8	2.03	R/LT1601L-8WM		8	2.03
R/LT2201G-7WM		7	2.41	R/LT2201L-7WM		7	2.41
R/LT2201G-6WM		6	2.71	R/LT2201L-6WM		6	2.71
R/LT2201G-5WM		5	3.25	R/LT2201L-5WM		5	3.25
R/LT2701G-4.5WM		4.5	3.61	R/LT2701L-4.5WM		4.5	3.61
R/LT2701G-4WM		4	4.07	R/LT2701L-4WM		4	4.07

Threading Insert

British Standard Taper Pipe Thread

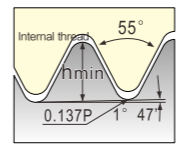
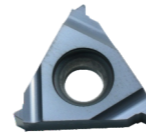

Application for insert
It is suitable for all machining

- Standard
B.S.21:1985
- Tolerance grade

External thread				Internal thread			
Ground type	Full pressed	Applicative pitch		Ground type	Full pressed	Applicative pitch	
		mm	TPI			mm	TPI
				R/LT0601L-28BSPTM		28	0.58
				R/LT0801L-28BSPTM		28	0.58
				R/LT0801L-19BSPTM		19	0.86
				R/LT1101L-19BSPTM		19	0.86
				R/LT1101L-14BSPTM		14	1.16
				R/LT1101L-11BSPTM		11	1.48
R/LT1601G-28BSPTM		28	0.58	R/LT1601L-28BSPTM		28	0.58
R/LT1601G-19BSPTM		19	0.86	R/LT1601L-19BSPTM		19	0.86
R/LT1601G-14BSPTM	RT1601G-14BSPTA	14	1.16	R/LT1601L-14BSPTM	RT1601L-14BSPTA	14	1.16
R/LT1601G-11BSPTM	RT1601G-11BSPTA	11	1.48	R/LT1601L-11BSPTM	RT1601L-11BSPTA	11	1.48

Threading Insert

NPT American Standard Taper Pipe Thread

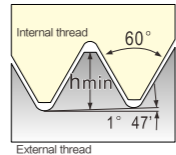
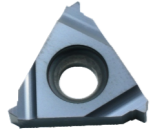

▶ Application for insert

It is suitable for all machining

- ▶ Standard
USAS B2. 1:1968
- ▶ Tolerance grade

External thread			Internal thread		
Ground type	Applicative pitch		Ground type	Applicative pitch	
	mm	TPI		mm	TPI
			R/LT0601L-27NPTM	27	0.66
			R/LT0801L-27NPTM	27	0.66
			R/LT0801L-18NPTM	18	1.01
			R/LT1101L-18NPTM	18	1.01
			R/LT1101L-14NPTM	14	1.33
R/LT1601G-27NPTM	27	0.66			
R/LT1601G-18NPTM	18	1.01	R/LT1601L-18NPTM	18	1.01
R/LT1601G-14NPTM	14	1.33	R/LT1601L-14NPTM	14	1.33
R/LT1601G-11.5NPTM	11.5	1.64	R/LT1601L-11.5NPTM	11.5	1.64
R/LT1601G-8NPTM	8	2.42	R/LT1601L-8NPTM	8	2.42

Threading Insert

UNJ American Standard Aerospace and Aviation Thread

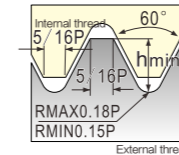
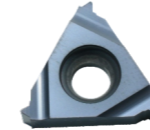

▶ Application for insert

It is suitable for all machining

- ▶ Standard
MIL-D-8879C
- ▶ Tolerance grade
3A/3B

External thread			Internal thread		
Ground type	Applicative pitch		Ground type	Applicative pitch	
	mm	TPI		mm	TPI
			R/LT0601L-18UNJM	18	0.74
			R/LT0801L-16UNJM	16	0.83
			R/LT0801L-14UNJM	14	0.95
			R/LT1101L-12UNJM	12	1.11
R/LT1601G-40UNJM	40	0.37			
R/LT1601G-36UNJM	36	0.41			
R/LT1601G-32UNJM	32	0.46			
R/LT1601G-28UNJM	28	0.52			
R/LT1601G-24UNJM	24	0.61			
R/LT1601G-20UNJM	20	0.73			
R/LT1601G-18UNJM	18	0.81			
R/LT1601G-16UNJM	16	0.92			
R/LT1601G-14UNJM	14	1.05			
R/LT1601G-12UNJM	12	1.22			
R/LT1601G-10UNJM	10	1.47	R/LT1601L-10UNJM	10	1.33
R/LT1601G-8UNJM	8	1.83	R/LT1601L-8UNJM	8	1.66
R/LT2201G-7UNJM	7	2.09	R/LT2201L-7UNJM	7	1.90
R/LT2201G-6UNJM	6	2.44	R/LT2201L-6UNJM	6	2.21
R/LT2201G-5UNJM	5	2.93	R/LT2201L-5UNJM	5	2.66
R/LT2701G-4.5UNJM	4.5	3.26	R/LT2701L-4.5UNJM	4.5	2.95
R/LT2701G-4UNJM	4	3.67	R/LT2701L-4UNJM	4	3.32

Threading Insert

30° DIN405 Round Thread

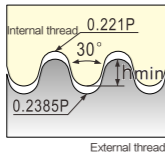
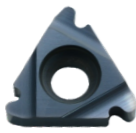

► Application for insert

It is suitable for all machining

► Standard
DIN405

► Tolerance grade
7h/7H

External thread		
Ground type	Applicative pitch	
	mm	TPI
R/LT1601G-10RDM	10	1.27
R/LT1601G-8RDM	8	1.59
R/LT1601G-6RDM	6	2.12
R/LT2201G-6RDM	6	2.12
R/LT2201G-4RDM	4	3.18

Internal thread		
Ground type	Applicative pitch	
	mm	TPI
R/LT1601L-10RDM	10	1.27
R/LT1601L-8RDM	8	1.59
R/LT1601L-6RDM	6	2.12
R/LT2201L-6RDM	6	2.12
R/LT2201L-4RDM	4	3.18

Threading Insert

30° ISO Metric Thread

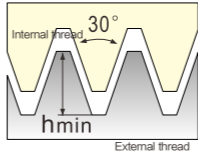
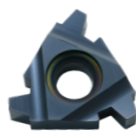

► Application for insert

It is suitable for all machining

► Standard
DIN103

► Tolerance grade
7e/7H

External thread		
Ground type	Applicative pitch	
	mm	TPI
R/LT1601G-1.5TRM	1.5	0.90
R/LT1601G-2TRM	2	1.25
R/LT1601G-3TRM	3	1.75
R/LT2201G-4TRM	4	2.25
R/LT2201G-5TRM	5	2.75
R/LT2701G-6TRM	6	3.50
R/LT2701G-7TRM	7	4.00

Internal thread		
Ground type	Applicative pitch	
	mm	TPI
R/LT1601L-1.5TRM	1.5	0.90
R/LT1601L-2TRM	2	1.25
R/LT1601L-3TRM	3	1.75
R/LT2201L-4TRM	4	2.25
R/LT2201L-5TRM	5	2.75
R/LT2701L-6TRM	6	3.50
R/LT2701L-7TRM	7	4.00

Petroleum Pipeline Threading insert

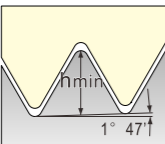
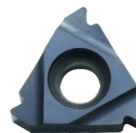

► Application for insert

It is suitable for all machining

► Standard
STD.5B.1979

► Tolerance grade

external thread		
ground type	applicative pitch	
	mm	TPI
R/LT1601G-10APIRDM	10	1.41
R/LT1601G-8APIRDM	8	1.81

internal thread		
ground type	applicative pitch	
	mm	TPI
R/LT1601L-10APIRDM	10	1.41
R/LT1601L-8APIRDM	8	1.81

Threading Insert

29° American ACME Thread

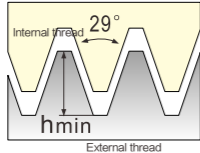
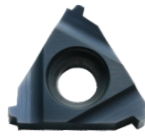

► Application for insert

It is suitable for all machining

► Standard
ANSI B1.5:1988

► Tolerance grade
3G

External thread		
Ground type	Applicative pitch	
	mm	TPI
R/LT1601G-12ACMEM	12	1.19
R/LT1601G-10ACMEM	10	1.52
R/LT1601G-8ACMEM	8	1.84
R/LT2201G-6ACMEM	6	2.37
R/LT2201G-5ACMEM	5	2.79
R/LT2701G-4ACMEM	4	3.43

Internal thread		
Ground type	Applicative pitch	
	mm	TPI
R/LT1601L-8ACMEM	8	1.84
R/LT2201L-6ACMEM	6	2.37
R/LT2201L-5ACMEM	5	2.79
R/LT2701L-4ACMEM	4	3.43

Threading Insert

29° American STACME Thread

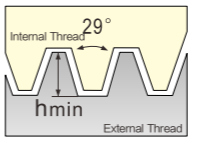
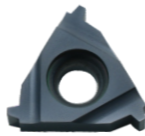

► Application for insert

It is suitable for all machining

► Standard
ANSI B1.8:1988



► Tolerance grade
2G



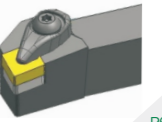
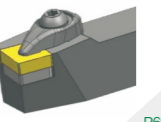
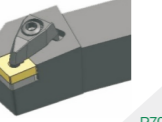
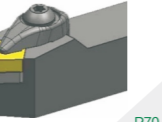
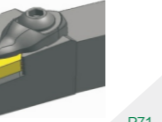

External thread		
Ground type	Applicative pitch	
	mm	TPI
R/LT1601G-12STACMEM	12	0.76
R/LT1601G-10STACMEM	10	1.02
R/LT1601G-8STACMEM	8	1.21
R/LT2201G-6STACMEM	6	1.52
R/LT2201G-5STACMEM	5	1.78
R/LT2701G-4STACMEM	4	2.16
R/LT2701G-3STACMEM	3	2.79

Internal thread		
Ground type	Applicative pitch	
	mm	TPI
R/LT2201L-5STACMEM	5	1.78
R/LT2701L-4STACMEM	4	2.16
R/LT2701L-3STACMEM	3	2.79

External Turning Tools List

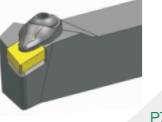
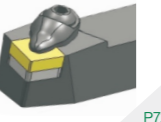
Wedge Clamping

DCLNR/L	DCBNR/L	DCKNR/L	DCMNN	DDJNR/L	DDPNN
 P69	 P69	 P70	 P70	 P71	 P71

DDQNR/L	DSBNR/L	DSDNN	DSSNR/L	DSKNR/L	DTGNR/L
 P72	 P72	 P73	 P73	 P74	 P74

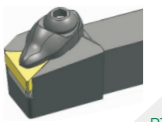
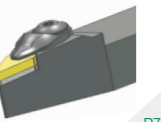
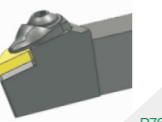
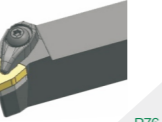





DTFNR/L	DVVNN	DVJNR/L	DWLR/L
 P75	 P75	 P76	 P76

External Turning Tools List

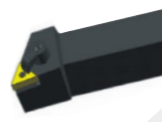
Top and Hole Clamping

MCLNR/L	MCBNR/L	MCKNR/L	MDJNR/L	MDQNR/L	MSBNR/L
 P77	 P77	 P78	 P78	 P79	 P80







MSRNR/L	MSKNR/L	MSDNN	MSSNR/L	MTGNR/L	MTJNR/L
 P80	 P81	 P81	 P82	 P82	 P83







MTJNR/L(B)	MTFNR/L	MTQNR/L	MTENN	MVJNR/L	MVVNN
 P83	 P84	 P84	 P85	 P85	 P86

MVUNR/L	MVQNR/L	MWLR/L	MRGNR/L	MRDNN
 P86	 P87	 P87	 P88	 P88

External Turning Tools List

Hole Clamping

PCBNR/L	PCLNR/L	PDJNR/L	PDNNR/L	PSBNR/L	PSDNN
 P89	 P89	 P90	 P90	 P91	 P91





PSKNR/L	PSSNR/L	PRDCN	PRGCR/L	PTGNR/L	PTFNR/L
 P92	 P92	 P93	 P93	 P94	 P95



PTTNR/L	PWLNLR/L
 P95	 P96

External Turning Tools List

Screw On

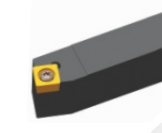
SCACR/L	SCLCR/L	SDACR/L	SDJCR/L	SDNCN	SVJCR/L
 P97	 P97	 P98	 P98	 P99	 P99

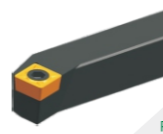
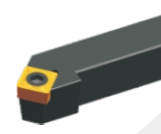
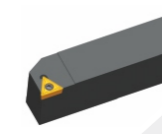
SVJBR/L	SVABR/L	SVACR/L	SVVBN	SVVCN	SSBCR/L
 P100	 P100	 P101	 P101	 P102	 P102

SSDCN	SSKCR/L	SSSCR/L	STACR/L	STFCR/L	STGCR/L
 P103	 P103	 P104	 P104	 P105	 P105

STTCR/L	SWACR/L	SRDCN	SRGCR/L	SRACR/L
 P106	 P106	 P107	 P107	 P108

Internal Turning Tools List

Top and Hole Clamping

MCKNR/L	MCLNR/L	MDQNR/L	MDUNR/L	MDZNR/L	MSKNR/L
 P111	 P111	 P112	 P112	 P113	 P113

MVQNR/L	MVUNR/L	MVWNR/L	MVXNR/L	MWLNR/L	MTFNR/L
 P114	 P114	 P115	 P115	 P116	 P116

MTQNR/L	MTJNR/L	MTUNR/L	MTWNR/L
 P117	 P117	 P118	 P118

Hole Clamping

PCLNR/L	PDSNR/L	PDUNR/L	PSKNR/L	PTFNR/L	PWLNR/L
 P119	 P119	 P120	 P120	 P121	 P121

Internal Turning Tools List

Screw On

SCLCR/L	SCLCR/L-H	SCKCR/L	SDQCR/L	SDXCR/L	SDWCR/L
 P122	 P122	 P123	 P123	 P124	 P124

SDUCR/L	SDZCR/L	SSKCR/L	SSSCR/L	STFCR/L	STWCR/L
 P125	 P125	 P126	 P126	 P127	 P127

STFPR/L	STUCR/L	SVQCR/L	SVQBR/L	SVUCR/L	SVWCR/L
 P128	 P128	 P129	 P129	 P130	 P130

SVXCR/L	SVZCR/L
 P131	 P132

External Turning Tools List

External Parting and Grooving Tools

QEED1616R/L10

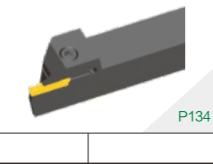

Turning and Face Grooving Tools

QFFD2525R/L10-48H

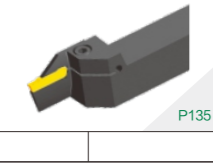

QFFD2525R/L10-48L

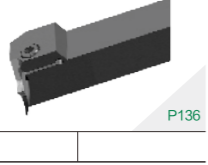

ZQ Part Off Cutting Tools

ZQ1616R03

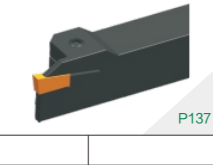

B

C

D

E

External Turning Tools List

External Parting Blade

SPB326-S



External Threading Turning Tools

SWR/L1010H11

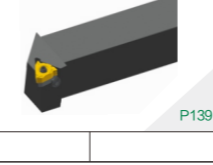

Internal Threading Turning Tools

SNR/L1010K11

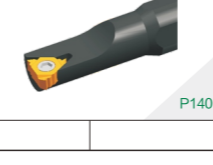

B

C





D

E

External Turning Tools Naming Rule







Clamping System

M C L N R 25 25 M 12

P  hole clamping	S  Screw on
M  Top and hole clamping	C  Top clamping
D  Top clamping	

Insert Shape

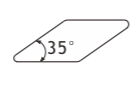
M C L N R 25 25 M 12

C  80°	D  55°	R 
S  90°	T  60°	V  35°
W  80°		





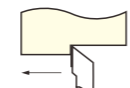
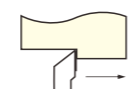
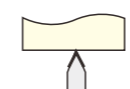



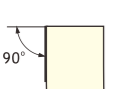

Cutting Direction

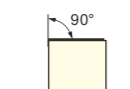
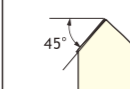
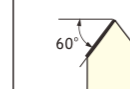
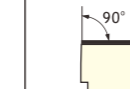
M C L N R
25 25 M 12

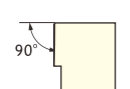
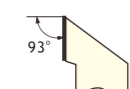
R 
L 
N 

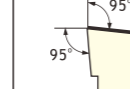
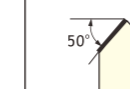
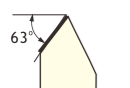
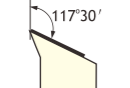
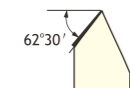
Holder Style and Leading Angle

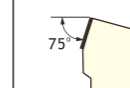
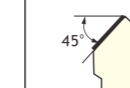
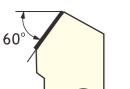
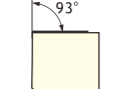
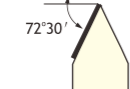
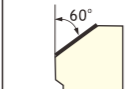
M C L N R 25 25 M 12

A  90°	B  75°	C  90°	D  45°	E  60°	F  90°
H  107°30'	G  90°	J  93°	K  75°	L  95°	M  50°
N  63°	O  117°30'	P  62°30'	Q  107°30'	R  75°	S  45°
T  60°	U  93°	V  72°30'	W  60°	X  120°	

Insert Clearance Angle

M C L N R
25 25 M 12

N	0°
B	5°
C	7°
P	11°
D	15°
E	20°

External Turning Tools Naming Rule

Tools-tip Height

M C L N R 25 25 M 12

		12	16	20	25	32	40	50
HF	12	16	20	25	32	40	50	

Integers to be preceded by 0 eg:h=8 indicated by 08

Shank Width

M C L N R 25 25 M 12

		12	16	20	25	32	40	50
B	12	16	20	25	32	40	50	

Integers to be preceded by 0 eg:h=8 indicated by 08







Tool Length

M C L N R 25 25 M 12

Code	D	E	F	G	H	K	M	P
Length	60	70	80	90	100	125	150	170
Code	Q	R	S	T	U	V	W	
Length	180	200	250	300	350	400	450	





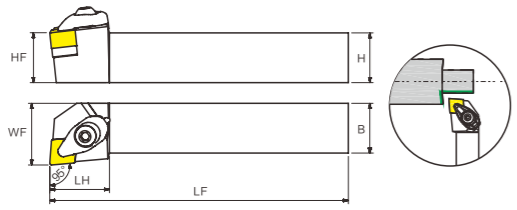

Cutting Edge Length

M C L N R 25 25 M 12

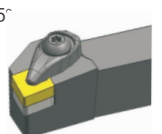



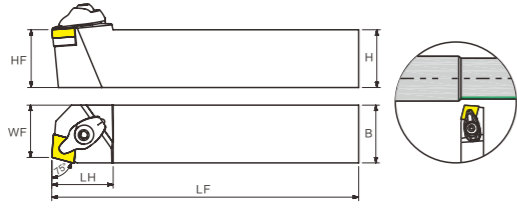

	C	D	R	S	T	V	W
Cutting Tool Shape							
Inscribed Circle	Cutting Edge Length						
5.556					09		
6.350	06	07			11		
9.525	09	11	09	09	16	16	06
12.700	12	15	12	12	22	22	08
15.875	16	19	15	15	27		
19.050	19		19	19	33		
25.400	25		25	25	44		

D Type External Turning Tool Holder

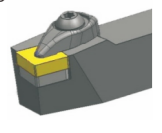







DCLNR/L	Type	Dimension						Adaptable Inserts	Shim	Wrench	Clamp	Clamping Screw	Screw
		H	B	LF	HF	WF	LH						
 95°	DCLNR/L 2020K12	20	20	125	20	27	32	 CN□□1204□□	 MC1204	 S4 S3	 DCL2612	 DM0625	 DSP0612
	DCLNR/L 2525M12	25	25	150	25	32	30						
	DCLNR/L 3232P12	32	32	170	32	39	30						

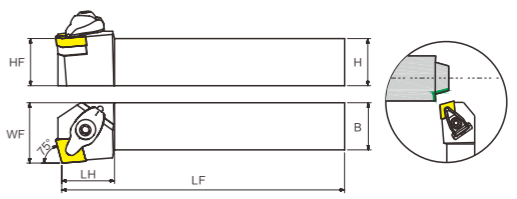

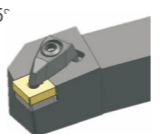



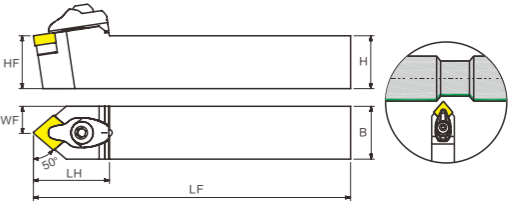

DCBNR/L	Type	Dimension						Adaptable Inserts	Shim	Wrench	Clamp	Clamping Screw	Screw
		H	B	LF	HF	WF	LH						
 75°	DCBNR/L 2020K12	20	20	125	20	17	34	 CN□□1204□□	 MC1204	 S4 S3	 DCL2612	 DM0625	 DSP0612
	DCBNR/L 2525M12	25	25	150	25	22	36						
	DCBNR/L 3232P12	32	32	170	32	29	34						

D Type External Turning Tool Holder

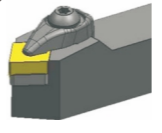

DCKNR/L	Type	Dimension						Adaptable Inserts	Shim	Wrench	Clamp	Clamping Screw	Screw
		H	B	LF	HF	WF	LH						
 75°	DCKNR/L 2020K12	20	20	125	20	26	28	 CN□□1204□□	 MC1204	 S4 S3	 DCL2612	 DM0625	 DSP0612
	DCKNR/L 2525M12	25	25	150	25	32	28						
	DCKNR/L 3232P12	32	32	170	32	39	28						



DCMNN	Type	Dimension						Adaptable Inserts	Shim	Wrench	Clamp	Clamping Screw	Screw
		H	B	LF	HF	WF	LH						
 50°	DCMNN 2020K12	20	20	125	20	10	36	 CN□□1204□□	 MC1204	 S4 S3	 DCL2612	 DM0625	 DSP0612
	DCMNN 2525M12	25	25	150	25	12.5	36						
	DCMNN 3232P12	32	32	170	32	16	36						

D Type External Turning Tool Holder

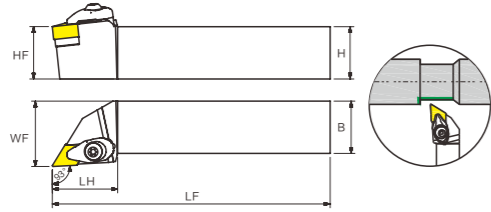

DDJNR/L	Type	Dimension						Adaptable Inserts	Shim	Wrench	Clamp	Clamping Screw	Screw	
		H	B	LF	HF	WF	LH							
	93°	DDJNR/L2020K11	20	20	125	20	25	32	DN□□1104□□	MD1103	S3	DCL2211	DM0520	DSP0510
	DDJNR/L2525M11	25	25	150	25	30	32							
	DDJNR/L2020K1504	20	20	125	20	25	40	DN□□1504□□	MD1504	S4 S3	DCL2612	DM0625	DSP0612	
	DDJNR/L2525M1504	25	25	150	25	31	40							
	DDJNR/L3232P1504	32	32	170	32	39	40	DN□□1506□□						
	DDJNR/L2020K1506	20	20	125	20	25	40							
	DDJNR/L2525M1506	25	25	150	25	31	40							
	DDJNR/L3232P1506	32	32	170	32	39	40							

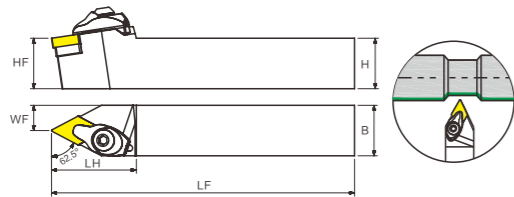

DDPNN	Type	Dimension						Adaptable Inserts	Shim	Wrench	Clamp	Clamping Screw	Screw	
		H	B	LF	HF	WF	LH							
	62.5°	DDPNN2020K11	20	20	125	20	10	32	DN□□1104□□	MD1103	S3	DCL2211	DM0520	DSP0510
	DDPNN2525M11	25	25	150	25	12.5	36							
	DDPNN2020K1504	20	20	125	20	10	36	DN□□1504□□	MD1504	S4 S3	DCL2612	DM0625	DSP0612	
	DDPNN2525M1504	25	25	150	25	12.5	36							
	DDPNN3232P1504	32	32	170	32	16	36	DN□□1506□□						
	DDPNN2020K1506	20	20	125	20	10	36							
	DDPNN2525M1506	25	25	150	25	12.5	36							
	DDPNN3232P1506	32	32	170	32	16	36							

D Type External Turning Tool Holder

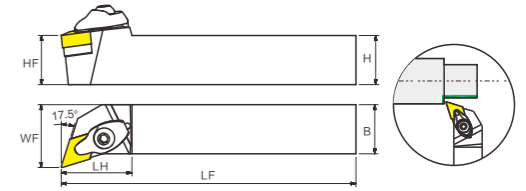

DDQNR/L	Type	Dimension						Adaptable Inserts	Shim	Wrench	Clamp	Clamping Screw	Screw	
		H	B	LF	HF	WF	LH							
	107.5°	DDQNR/L2020K11	20	20	125	20	25	28	DN□□1104□□	MD1103	S4 S3	DCL2211	DM0520	DSP0510
	DDQNR/L2525M11	25	25	150	25	31	28							
	DDQNR/L2020K1504	20	20	125	20	26	36	DN□□1504□□	MD1504	S4 S3	DCL2612	DM0625	DSP0612	
	DDQNR/L2525M1504	25	25	150	25	32	36							
	DDQNR/L3232P1504	32	32	170	32	38	36	DN□□1506□□						
	DDQNR/L2020K1506	20	20	125	20	26	36							
	DDQNR/L2525M1506	25	25	150	25	32	36							
	DDQNR/L3232P1506	32	32	170	32	38	36							

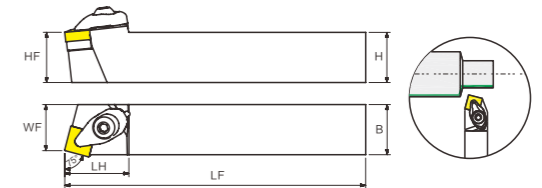

DSBNR/L	Type	Dimension						Adaptable Inserts	Shim	Wrench	Clamp	Clamping Screw	Screw	
		H	B	LF	HF	WF	LH							
	75°	DSBNR/L 2020K12	20	20	125	20	18	34	SN□□1204□□	MS1204	S3 S4	DCL2612	DM0625	DSP0612
	DSBNR/L 2525M12	25	25	150	25	23	32							
	DSBNR/L 3232P12	32	32	170	32	30	33							

D Type External Turning Tool Holder

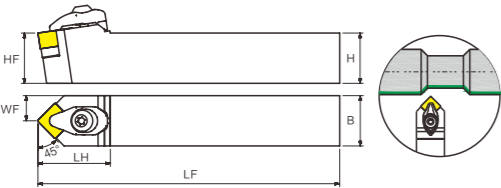

DSDNN	Type	Dimension						Adaptable Inserts	Shim	Wrench	Clamp	Clamping Screw	Screw
		H	B	LF	HF	WF	LH						
	DSDNN 2020K12	20	20	125	20	10	36						
	DSDNN 2525M12	25	25	150	25	12.5	36						
	DSDNN 3232P12	32	32	170	32	12.5	36						

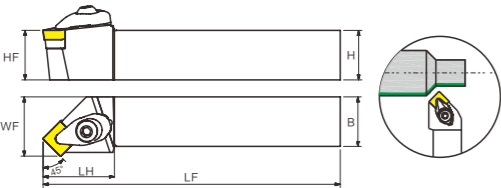

DSSNR/L	Type	Dimension						Adaptable Inserts	Shim	Wrench	Clamp	Clamping Screw	Screw
		H	B	LF	HF	WF	LH						
	DSSNR/L 2020K12	20	20	125	20	25	36						
	DSSNR/L 2525M12	25	25	150	25	30	36						
	DSSNR/L 3232P12	32	32	170	32	38	36						

D Type External Turning Tool Holder

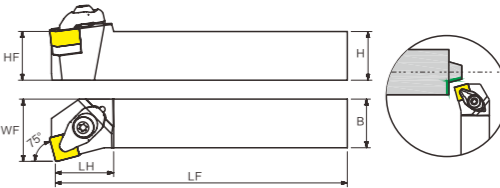



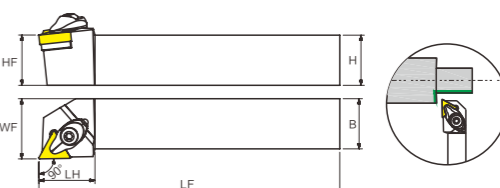



DSKNR/L	Type	Dimension						Adaptable Inserts	Shim	Wrench	Clamp	Clamping Screw	Screw
		H	B	LF	HF	WF	LH						
	DSKNR/L 2020K12	20	20	125	20	26	28						
	DSKNR/L 2525M12	25	25	150	25	36	28						
	DSKNR/L 3232P12	32	32	170	32	38	32						

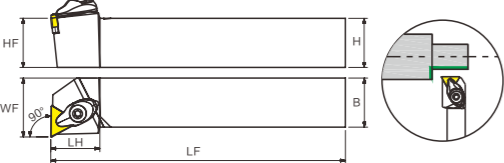

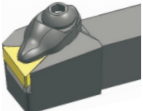



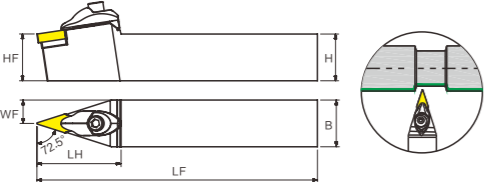

DTGNR	Type	Dimension						Adaptable Inserts	Shim	Wrench	Clamp	Clamping Screw	Screw
		H	B	LF	HF	WF	LH						
	DTGNR 2020K16	20	20	125	20	24	28						
	DTGNR 2525M16	25	25	150	25	30	28						
	DTGNR 3225P16	32	25	170	32	30	28						
	DTGNR 3232P16	32	32	170	32	38	32						

D Type External Turning Tool Holder

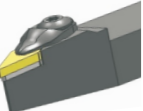







DTFNR/L	Type	Dimension						Adaptable Inserts	Shim	Wrench	Clamp	Clamping Screw	Screw
		H	B	LF	HF	WF	LH						
	DTFNR/L 2020K16	20	20	125	20	25	28						
	DTFNR/L 2525M16	25	25	150	25	30	26						
	DTFNR/L 3225P16	32	25	170	32	30	26						
	DTFNR/L 3232P16	32	32	170	32	38	26						

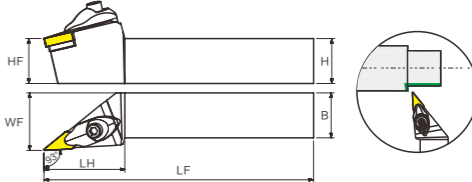

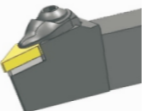







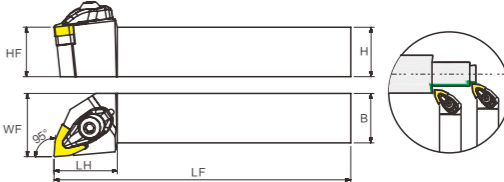





DVVNN	Type	Dimension						Adaptable Inserts	Shim	Wrench	Clamp	Clamping Screw	Screw
		H	B	LF	HF	WF	LH						
	DVVNN2020K16	20	20	125	20	10	45						
	DVVNN2525M16	25	25	150	25	12.5	45						
	DVVNN3225P16	32	25	170	32	12.5	45						
	DVVNN3232P16	32	32	170	32	16	45						

D Type External Turning Tool Holder



DVJNR/L	Type	Dimension						Adaptable Inserts	Shim	Wrench	Clamp	Clamping Screw	Screw
		H	B	LF	HF	WF	LH						
	DVJNR/L 2020K16	20	20	125	20	26	45						
	DVJNR/L 2525M16	25	25	150	25	32	45						
	DVJNR/L 3225P16	32	25	170	32	32	45						
	DVJNR/L 3232P16	32	32	170	32	40	45						



DWLNR/L	Type	Dimension						Adaptable Inserts	Shim	Wrench	Clamp	Clamping Screw	Screw						
		H	B	LF	HF	WF	LH												
	DWLNR/L 2020K08	20	20	125	20	25	32												
	DWLNR/L 2525M08	25	25	150	25	32	31												
	DWLNR/L 3225P08	32	25	170	32	32	31												
	DWLNR/L 3232P08	32	32	170	32	39	31												
	DWLNR/L 2020K06	20	20	125	20	25	25												
	DWLNR/L 2525M06	25	25	150	25	30	25												

M Type External Turning Tool Holder

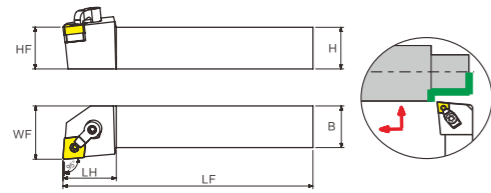

MCLNR/L	Type	Dimension						Adaptable Inserts	Clamping Screw	Shim	Wrench	Clamp	Screw
		H	B	LF	HF	WF	LH						
95°	MCLNR/L1616H12	16	16	100	16	21	30	CN□□1204□□	WS061025	MC1204	S3	MCL1814	MSP617
	MCLNR/L2020K12	20	20	125	20	25	28						
	MCLNR/L2525M12	25	25	150	25	32	32						
	MCLNR/L3225P12	32	25	170	32	32	32	WS081030	MC1604	S3	MCL2114	MSP821	
	MCLNR/L3232P12	32	32	170	32	39	32						
	MCLNR/L2525M16	25	25	150	25	32	38	CN□□1606□□	WS061030	MC1604	S3	MCL2114	MSP821
	MCLNR/L3225P16	32	25	170	32	33	38						
	MCLNR/L3232P16	32	32	170	32	40	38						
	MCLNR/L3232P19	32	32	170	32	40	43	CN□□1906□□	WS081030	MC1904	S4	MCL2217	MSP1021
	MCLNR/L4040R19	40	40	200	40	50	43						

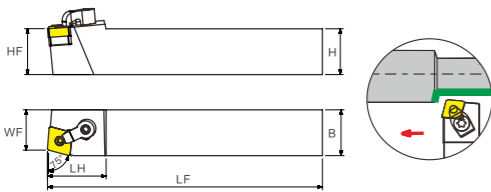

MCBNR/L	Type	Dimension						Adaptable Inserts	Clamping Screw	Shim	Wrench	Clamp	Screw
		H	B	LF	HF	WF	LH						
75°	MCBNR/L2020K12	20	20	125	20	17	32	CN□□1204□□	WS061025	MC1204	S3	MCL1814	MSP617
	MCBNR/L2525M12	25	25	150	25	22	32						
	MCBNR/L3225P12	32	25	170	32	22	32		WS061030				
	MCBNR/L2525M16	25	25	150	25	22	36						
	MCBNR/L3225P16	32	25	170	32	22	35	CN□□1606□□	WS061030	MC1604	S3	MCL2114	MSP822
	MCBNR/L3232P16	32	32	170	32	27	35						
	MCBNR/L3232P19	32	32	170	32	27	40						
	MCBNR/L4040R19	40	40	200	40	35	40						

M Type External Turning Tool Holder

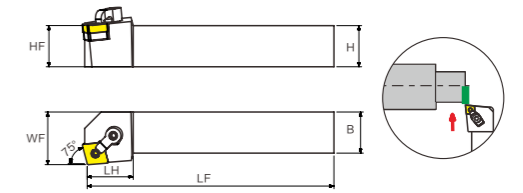

MCKNR/L	Type	Dimension						Adaptable Inserts	Clamping Screw	Shim	Wrench	Clamp	Screw
		H	B	LF	HF	WF	LH						
75°	MCKNR/L2020K12	20	20	125	20	25	28	CN□□1204□□	WS061025	MC1204	S3	MCL1814	MSP617
	MCKNR/L2525M12	25	25	150	25	32	28						
	MCKNR/L3225P12	32	25	170	32	32	28		WS061030				
	MCKNR/L2525M16	25	25	150	25	32	30						
	MCKNR/L3225P16	32	25	170	32	32	30	CN□□1606□□	WS061030	MC1604	S3	MCL2114	MSP821
	MCKNR/L3232P16	32	32	170	32	38	30						
	MCKNR/L3232P19	32	32	170	32	40	36						
	MCKNR/L4040R19	40	40	200	40	48	36						

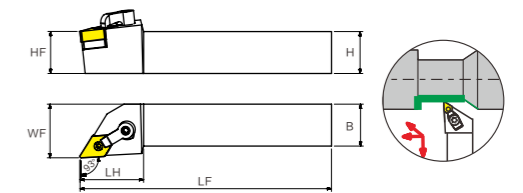

MDJNR/L	Type	Dimension						Adaptable Inserts	Clamping Screw	Shim	Wrench	Clamp	Screw
		H	B	LF	HF	WF	LH						
93°	MDJNR/L1616H11	16	16	100	16	20	30	DN□□1104□□	WS061025	MD1103	S2 S3	MCL1814	MSP513
	MDJNR/L2020K11	20	20	125	20	25	32						
	MDJNR/L2525M11	25	25	150	25	32	32		WS061030				
	MDJNR/L3225P11	32	25	170	32	32	32						
	MDJNR/L2020K1504/06	20	20	125	20	25	36	DN□□1504□□ DN□□1506□□	WS061030	MD1504	S3	MCL2114	04:MSP617 06:MSP619
	MDJNR/L2525M1504/06	25	25	150	25	32	38						
	MDJNR/L3225P1504/06	32	25	170	32	32	38						
	MDJNR/L3232P1504/06	32	32	170	32	40	38	DN□□1506□□	WS061030	MD1504	S3	MCL2114	04:MSP617 06:MSP619
	MDJNR/L4040R15	40	40	200	40	48	40						

M Type External Turning Tool Holder

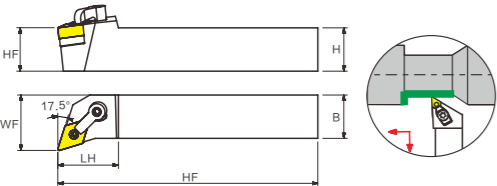

MDQNR/L	Type	Dimension						Adaptable Inserts	Clamping Screw	Shim	Wrench	Clamp	Screw
		H	B	LF	HF	WF	LH						
107.5°	MDQNR/L1616H11	16	16	100	16	21	30	DN□□1104□□	WS061025	MD1103	S2 S3	MCL1814	MSP513
	MDQNR/L2020K11	20	20	125	20	25	32		WS061030				
	MDQNR/L2525M11	25	25	150	25	30	30	DN□□1504□□	WS061025	MD1504	S3	MCL2114	04:MSP617
	MDQNR/L3225P11	32	25	170	32	30	30		WS061030				06:MSP619
	MDQNR/L2020K1504/06	20	20	125	20	27	36	DN□□1506□□	WS061030	S4 S5	MCL3220	MSP1229	
	MDQNR/L2525M1504/06	25	25	150	25	32	35		WS101035				
	MDQNR/L3225P1504/06	32	25	170	32	32	35	SN□□2509□□	WS101035	MS2508	S4 S5	MCL3220	MSP1229
	MDQNR/L3232P1504/06	32	32	170	32	40	35						

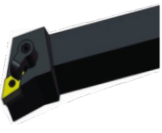

M Type External Turning Tool Holder

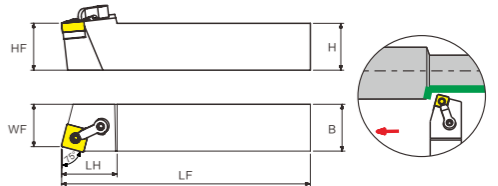

MSBNR/L	Type	Dimension						Adaptable Inserts	Clamping Screw	Shim	Wrench	Clamp	Screw
		H	B	LF	HF	WF	LH						
75°	MSBNR/L2020K12	20	20	125	20	17	34	SN□□1204□□	WS061025	MS1204	S3	MCL1814	MSP617
	MSBNR/L2525M12	25	25	150	25	22	32		WS061030				
	MSBNR/L3225P12	32	25	170	32	22	32	SN□□1506□□	WS061030	MS1504	S3	MCL2114	MSP821
	MSBNR/L2525M15	25	25	150	25	22	38		WS081030				
	MSBNR/L3232P15	32	32	170	32	29	38	SN□□1906□□	WS081030	MS1904	S4	MCL2217	MSP1021
	MSBNR/L3232P19	32	32	170	32	27	45						
	MSBNR/L4040R19	40	40	200	40	35	45	SN□□2509□□	WS101035	MS2508	S4 S5	MCL3220	MSP1229
	MSBNR/L4040S25	40	40	250	40	34	60						

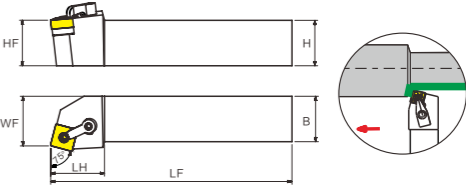

MSRNR/L	Type	Dimension						Adaptable Inserts	Clamping Screw	Shim	Wrench	Clamp	Screw
		H	B	LF	HF	WF	LH						
75°	MSRNR/L2020K12	20	20	125	20	22	32	SN□□1204□□	WS061025	MS1204	S3	MCL1814	MSP617
	MSRNR/L2525M12	25	25	150	25	27	32		WS061030				
	MSRNR/L3225P12	32	25	170	32	27	32	SN□□1506□□	WS061030	MS1504	S3	MCL2114	MSP821
	MSRNR/L2525M15	25	25	150	25	27	38		WS081030				
	MSRNR/L3232P15	32	32	170	32	35	38	SN□□1906□□	WS081030	MS1904	S4	MCL2217	MSP1021
	MSRNR/L3232P19	32	32	170	32	35	45						
	MSRNR/L4040R19	40	40	200	40	43	45	SN□□2509□□	WS101035	MS2508	S4 S5	MCL3220	MSP1229
	MSRNR/L4040S25	40	40	250	40	43	55						

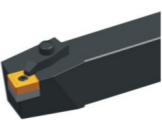

M Type External Turning Tool Holder

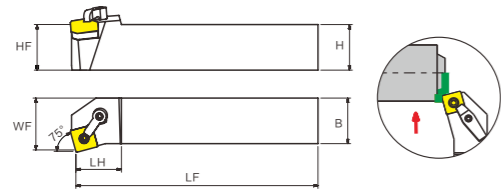

MSKNR/L	Type	Dimension						Adaptable Inserts	Clamping Screw	Shim	Wrench	Clamp	Screw
		H	B	LF	HF	WF	LH						
	MSKNR/L2020K12	20	20	125	20	25	28	SN□□1204□□	WS061025	MS1204	S3	MCL1814	MSP617
	MSKNR/L2525M12	25	25	150	25	32	27		WS061030				
	MSKNR/L3225P12	32	25	170	32	32	27	SN□□1506□□	WS061030	MS1504	S3	MCL2114	MSP821
	MSKNR/L2525M15	25	25	150	25	32	32						
	MSKNR/L3232P15	32	32	170	32	38	32	SN□□1906□□	WS081030	MS1904	S4	MCL2217	MSP1021
	MSKNR/L3232P19	32	32	170	32	38	36						
	MSKNR/L4040R19	40	40	200	40	50	40	SN□□2509□□	WS101035	MS2508	S4 S5	MCL3220	MSP1229
	MSKNR/L4040S25	40	40	250	40	50	45						

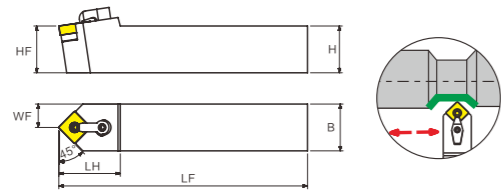

MSDNN	Type	Dimension						Adaptable Inserts	Clamping Screw	Shim	Wrench	Clamp	Screw
		H	B	LF	HF	WF	LH						
	MSDNN2020K12	20	20	125	20	10	34	SN□□1204□□	WS061025	MS1204	S3	MCL1814	MSP617
	MSDNN2525M12	25	25	150	25	12.5	34		WS061030				
	MSDNN3225P12	32	25	170	32	12.5	34	SN□□1506□□	WS061030	MS1504	S3	MCL2114	MSP821
	MSDNN2525M15	25	25	150	25	12.5	42						
	MSDNN3225P15	32	32	170	32	16	42	SN□□1906□□	WS081030	MS1904	S4	MCL2217	MSP1021
	MSDNN3232P19	32	32	170	32	16	45						
	MSDNN4040R19	40	40	200	40	20	50	SN□□2509□□	WS101035	MS2508	S4 S5	MCL3220	MSP1229
	MSDNN4040S25	40	40	250	40	20	60						

M Type External Turning Tool Holder

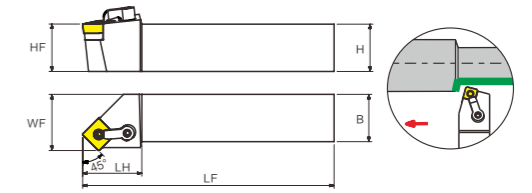

MSSNR/L	Type	Dimension						Adaptable Inserts	Clamping Screw	Shim	Wrench	Clamp	Screw
		H	B	LF	HF	WF	LH						
	MSSNR/L2020K12	20	20	125	20	25	36	SN□□1204□□	WS061025	MS1204	S3	MCL1814	MSP617
	MSSNR/L2525M12	25	25	150	25	30	36		WS061030				
	MSSNR/L3225P12	32	25	170	32	30	33	SN□□1506□□	WS061030	MS1504	S3	MCL2114	MSP821
	MSSNR/L3232P12	32	32	170	32	38	35						
	MSSNR/L2525M15	25	25	150	25	30	40	SN□□1906□□	WS081030	MS1904	S4	MCL2217	MSP1021
	MSSNR/L3232P15	32	32	170	32	38	40						
	MSSNR/L3232P19	32	32	170	32	38	45	SN□□2509□□	WS101035	MS2508	S4 S5	MCL3220	MSP1229
	MSSNR/L4040R19	40	40	200	40	46	45						
	MSSNR/L4040S25	40	40	250	40	50	60						

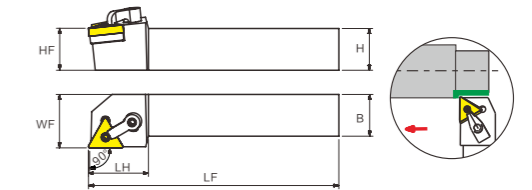

MTGNR/L	Type	Dimension						Adaptable Inserts	Clamping Screw	Shim	Wrench	Clamp	Screw
		H	B	LF	HF	WF	LH						
	MTGNR/L2020K16	20	20	125	20	25	32	TN□□1604□□	WS061025	MT1603	S2 S3	MCL1814	MSP513
	MTGNR/L2525M16	25	25	150	25	32	30		WS061030				
	MTGNR/L3225P16	32	25	170	32	32	30	TN□□2204□□	WS061030	MT2204	S3	MCL2114	MSP617
	MTGNR/L2525M22	25	25	150	25	32	36						
	MTGNR/L3225P22	32	25	170	32	32	36	SN□□2204□□	WS061030	MT2204	S3	MCL2114	MSP617
	MTGNR/L3232P22	32	32	170	32	38	36						

M Type External Turning Tool Holder

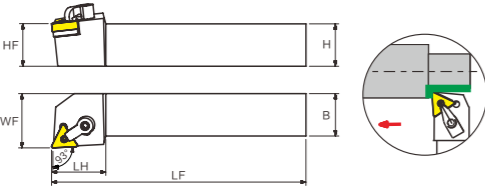

MTJNR/L	Type	Dimension						Adaptable Inserts	Clamping Screw	Shim	Wrench	Clamp	Screw
		H	B	LF	HF	WF	LH						
93°	MTJNR/L1616H16	16	16	100	16	20	28	TN□□1604□□	WS061025	MT1603	S2 S3	MCL1814	MSP513
	MTJNR/L2020K16	20	20	125	20	25	32		WS061030				
	MTJNR/L2525M16	25	25	150	25	32	32						
	MTJNR/L3225P16	32	25	170	32	32	32						
	MTJNR/L3232P16	32	32	170	32	32	32						
	MTJNR/L2525M22	25	25	150	25	32	36	TN□□2204□□	WS061030	MT2204	S3	MCL2114	MSP617
	MTJNR/L3225P22	32	25	170	32	32	36						
	MTJNR/L3232P22	32	32	170	32	38	36						

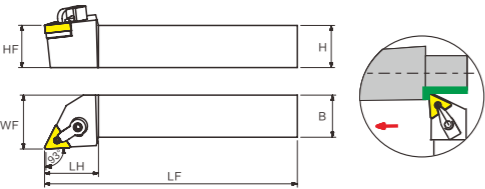

MTJNR/L(B)	Type	Dimension						Adaptable Inserts	Clamping Screw	Shim	Wrench	Clamp	Screw
		H	B	LF	HF	WF	LH						
93°	MTJNR/L1616H16(B)	16	16	100	16	20	28	TN□□1604□□	WS061025	MT1603	S2 S3	MCL1814	MSP513
	MTJNR/L2020K16(B)	20	20	125	20	25	32		WS061030				
	MTJNR/L2525M16(B)	25	25	150	25	32	32						
	MTJNR/L3225P16(B)	32	25	170	32	32	32						
	MTJNR/L3232P16(B)	32	32	170	32	32	32						
	MTJNR/L2525M22(B)	25	25	150	25	32	36	TN□□2204□□	WS061030	MT2204	S3	MCL2114	MSP617
	MTJNR/L3225P22(B)	32	25	170	32	32	36						
	MTJNR/L3232P22(B)	32	32	170	32	38	36						

M Type External Turning Tool Holder

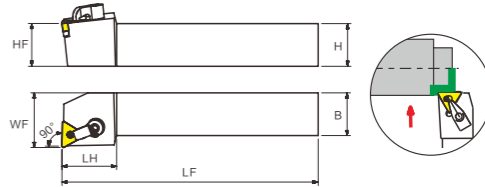

MTFNR/L	Type	Dimension						Adaptable Inserts	Clamping Screw	Shim	Wrench	Clamp	Screw	
		H	B	LF	HF	WF	LH							
90°	MTFNR/L1616H16	16	16	100	16	21	28	TN□□1604□□	WS061025	MT1603	S2 S3	MCL1814	MSP513	
	MTFNR/L2020K16	20	20	125	20	25	30							WS061030
	MTFNR/L2525M16	25	25	150	25	32	32							
	MTFNR/L3225P16	32	25	170	32	32	32							
	MTFNR/L3232P16	32	32	170	32	38	32							
	MTFNR/L2525M22	25	25	150	25	32	36	TN□□2204□□	WS061030	MT2204	S3	MCL2114	MSP617	
	MTFNR/L3225P22	32	25	170	32	32	36							
	MTFNR/L3232P22	32	32	170	32	38	36							

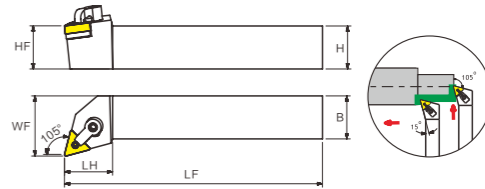

MTQNR/L	Type	Dimension						Adaptable Inserts	Clamping Screw	Shim	Wrench	Clamp	Screw
		H	B	LF	HF	WF	LH						
105°	MTQNR/L2020K16	20	20	125	20	29	25	TN□□1604□□	WS061025	MT1603	S2 S3	MCL1814	MSP513
	MTQNR/L2525M16	25	25	150	25	35	28		WS061030				
	MTQNR/L3225P16	32	25	170	32	35	25						
	MTQNR/L2525M22	25	25	150	25	38	36	TN□□2204□□	WS061030	MT2204	S3	MCL2114	MSP617
	MTQNR/L3232P22	32	32	170	32	46	36						

M Type External Turning Tool Holder

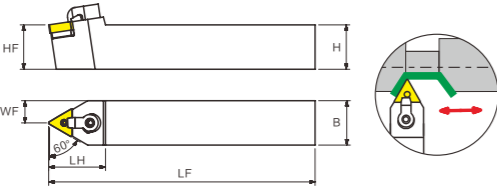

MTENN	Type	Dimension						Adaptable Inserts	Clamping Screw	Shim	Wrench	Clamp	Screw
		H	B	LF	HF	WF	LH						
	MTENN1616H16	16	16	100	16	8	32	TN□□1604□□	WS061025	MT1603	S2 S3	MCL1814	MSP513
	MTENN2020K16	20	20	125	20	10	34						
	MTENN2525M16	25	25	150	25	12.5	32						
	MTENN3232P16	32	32	170	32	16	32						

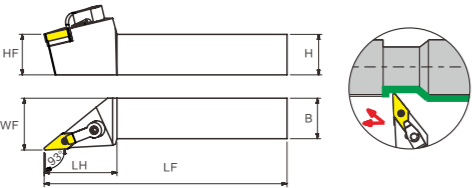

MVJNR/L	Type	Dimension						Adaptable Inserts	Clamping Screw	Shim	Wrench	Clamp	Screw
		H	B	LF	HF	WF	LH						
	MVJNR/L1616H16	16	16	100	16	22	43	VN□□1604□□	WS061025	MV1603	S2 S3	MCL2414	MSP513
	MVJNR/L2020K16	20	20	125	20	26	45						
	MVJNR/L2525M16	25	25	150	25	32	45						
	MVJNR/L3225P16	32	25	170	32	32	45						
	MVJNR/L3232P16	32	32	170	32	40	45						

M Type External Turning Tool Holder

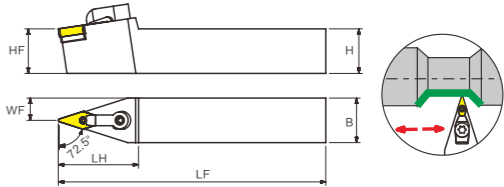



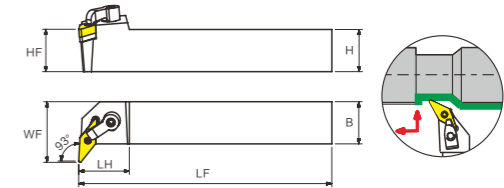



MVVNN	Type	Dimension						Adaptable Inserts	Clamping Screw	Shim	Wrench	Clamp	Screw
		H	B	LF	HF	WF	LH						
	MVVNN2020K16	20	20	125	20	10	45	VN□□1604□□	WS061025	MV1603	S2 S3	MCL2414	MSP513
	MVVNN2525M16	25	25	150	25	12.5	45						
	MVVNN3225P16	32	25	170	32	12.5	45						
	MVVNN3232P16	32	32	170	32	16	45						

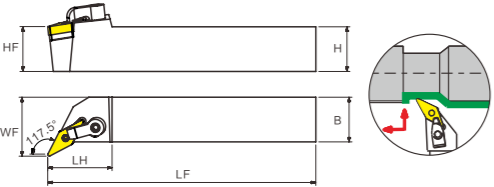

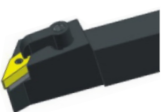
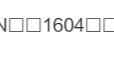





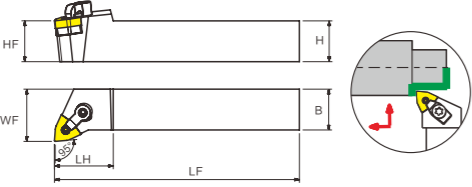

MVUNR/L	Type	Dimension						Adaptable Inserts	Clamping Screw	Shim	Wrench	Clamp	Screw
		H	B	LF	HF	WF	LH						
	MVUNR/L1616H16	16	16	100	16	20	45	VN□□1604□□	WS061025	MV1603	S2 S3	MCL2414	MSP513
	MVUNR/L2020K16	20	20	125	20	25	45						
	MVUNR/L2525M16	25	25	150	25	32	45						
	MVUNR/L3225P16	32	25	170	32	32	45						
	MVUNR/L3232P16	32	32	170	32	40	45						

M Type External Turning Tool Holder









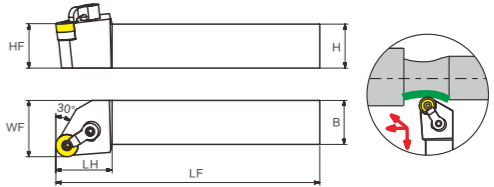

MVQNR/L	Type	Dimension						Adaptable Inserts	Clamping Screw	Shim	Wrench	Clamp	Screw
		H	B	LF	HF	WF	LH						
	MVQNR/L1616H16	16	16	100	16	24	36						
	MVQNR/L2020K16	20	20	125	20	27	36						
	MVQNR/L2525M16	25	25	150	25	33	36						
	MVQNR/L3225P16	32	25	170	32	33	36						
	MVQNR/L3232P16	32	32	170	32	40	36						









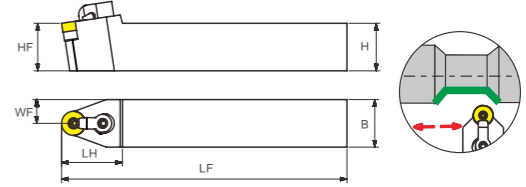

MWLNR/L	Type	Dimension						Adaptable Inserts	Clamping Screw	Shim	Wrench	Clamp	Screw
		H	B	LF	HF	WF	LH						
	MWLNR/L2020K06	20	20	125	20	25	28						
	MWLNR/L2525M06	25	25	150	25	32	30						
	MWLNR/L2020K08	20	20	125	20	26	28						
	MWLNR/L2525M08	25	25	150	25	32	35						
	MWLNR/L3225P08	32	25	170	32	32	35						
	MWLNR/L3232P08	32	32	170	32	40	35						

M Type External Turning Tool Holder



MRGNR/L	Type	Dimension						Adaptable Inserts	Clamping Screw	Shim	Wrench	Clamp	Screw
		H	B	LF	HF	WF	LH						
	MRGNR/L2020K12	20	20	125	20	25	28						
	MRGNR/L2525M12	25	25	150	25	32	32						
	MRGNR/L3225P12	32	25	170	32	32	32						
	MRGNR/L3232P12	32	32	170	32	39	32						



MRDNN	Type	Dimension						Adaptable Inserts	Clamping Screw	Shim	Wrench	Clamp	Screw
		H	B	LF	HF	WF	LH						
	MRDNN2020K12	20	20	125	20	1 0	30						
	MRDNN2525M12	25	25	150	25	12.5	32						
	MRDNN3225P12	32	25	170	32	12.5	30						
	MRDNN3232P12	32	32	170	32	1 6	30						

P Type External Turning Tool Holder

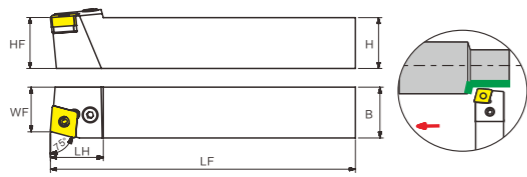

PCBNR/L	Type	Dimension						Adaptable Inserts	Screw	Shim	Wrench	Lever	Shim Pin						
		H	B	LF	HF	WF	LH												
	PCBNR/L2020K12	20	20	125	20	17	30												
	75°	PCBNR/L2525M12	25	25	150	25	22							CN□□1204□□	VHX0821	PC12318	S3	LV4	SP4
	PCBNR/L3232P12	32	32	170	32	29	27							CN□□1606□□	VHX0825	PC16476	S3	LV5	SP5
	PCBNR/L2525M16	25	25	150	25	22	32												
	PCBNR/L3232P16	32	32	170	32	27	33							CN□□1906□□	VHX1027	PC19476	S4	LV6	SP6
	PCBNR/L3232P19	32	32	170	32	27	38												
	PCBNR/L4040S19	40	40	250	40	35	38							CN□□2507□□	VHX1236	PC25	S5	LV8	SP8
	PCBNR/L4040S2507	40	40	250	40	37	50												
PCBNR/L4040S2509	40	40	250	40	37	50	CN□□2509□□												

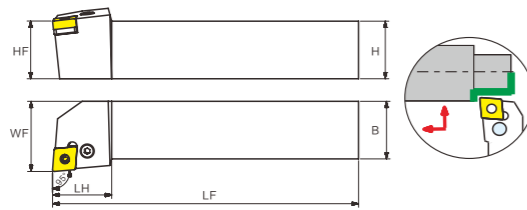

PCLNR/L	Type	Dimension						Adaptable Inserts	Screw	Shim	Wrench	Lever	Shim Pin						
		H	B	LF	HF	WF	LH												
	95°	PCLNR/L1616H09	16	16	100	16	20	20											
	PCLNR/L2020K09	20	20	125	20	25	22	CN□□0903□□							VHX0613	PC09318	S2.5	LV3	SP3
	PCLNR/L2525M09	25	25	150	25	32	22	CN□□1204□□							VHX0821	PC12318	S3	LV4	SP4
	PCLNR/L2020K12	20	20	125	20	26	28												
	PCLNR/L2525M12	25	25	150	25	32	28	CN□□1606□□							VHX0825	PC16476	S3	LV5	SP5
	PCLNR/L3232P12	32	32	170	32	39	32												
	PCLNR/L2525M16	25	25	150	25	32	36	CN□□1906□□							VHX1027	PC19476	S4	LV6	SP6
	PCLNR/L3232P16	32	32	170	32	39	36												
	PCLNR/L3232P19	32	32	170	32	40	40	CN□□2507□□							VHX1236	PC25	S5	LV8	SP8
	PCLNR/L4040S19	40	40	250	40	49	40												
PCLNR/L4040S2507	40	40	250	40	50	47	CN□□2507□□												
PCLNR/L4040S2509	40	40	250	40	50	47	CN□□2509□□												

P Type External Turning Tool Holder

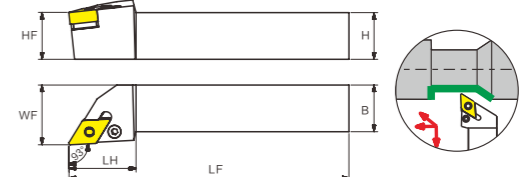

PDJNR/L	Type	Dimension						Adaptable Inserts	Screw	Shim	Wrench	Lever	Shim Pin						
		H	B	LF	HF	WF	LH												
	93°	PDJNR/L1616H11	16	16	100	16	20	25											
	PDJNR/L2020K11	20	20	125	20	25	25	DN□□1104□□							VHX0613	PD11270	S2.5	LV3	SP3
	PDJNR/L2525M11	25	25	150	25	30	30	DN□□1506□□							VHX0825	PD15318	S3	LV4B	SP4
	PDJNR/L2020K15	20	20	125	20	25	32												
	PDJNR/L2525M15	25	25	150	25	32	35	DN□□1504□□							VHX0821	PD15318	S3	LV4	SP4
	PDJNR/L3232P15	32	32	170	32	38	35												
	PDJNR/L2020K15-3	20	20	125	20	25	35	DN□□1504□□							VHX0821	PD15318	S3	LV4	SP4
	PDJNR/L2020M15-3	25	25	150	25	32	35												
PDJNR/L3232P15-3	32	32	170	32	38	35													

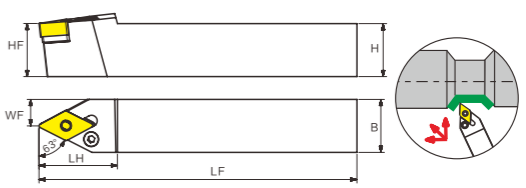

PDNNR/L	Type	Dimension						Adaptable Inserts	Screw	Shim	Wrench	Lever	Shim Pin						
		H	B	LF	HF	WF	LH												
	63°	PDNNR/L2020K15	20	20	125	20	8	37											
	PDNNR/L2525M15	25	25	150	25	12.5	37	DN□□1506□□							VHX0825	PD15318	S3	LV4B	SP4
	PDNNR/L3225P15	32	25	170	32	12.5	37												
	PDNNR/L3232P15	32	32	170	32	16	37	DN□□1504□□							VHX0821	PD15318	S3	LV4	SP4
	PDNNR/L2020K15-3	20	20	125	20	8	37												
	PDNNR/L2525M15-3	25	25	150	25	12.5	37												
PDNNR/L3232P15-3	32	32	170	32	16	37													

P Type External Turning Tool Holder

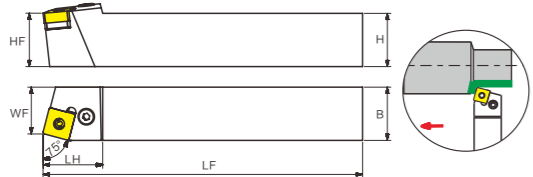

PSBNR/L	Type	Dimension						Adaptable Inserts	Screw	Shim	Wrench	Lever	Shim Pin
		H	B	LF	HF	WF	LH						
75°	PSBNR/L1616H09	16	16	100	16	13	21	SN□□0903□□	VHX0613	PS09318	S2.5	LV3	SP3
	PSBNR/L2020K09	20	20	125	20	17	23						
	PSBNR/L2020K12	20	20	125	20	17	28						
	PSBNR/L2525M12	25	25	150	25	22	28	SN□□1204□□	VHX0821	PS12318	S3	LV4	SP4
	PSBNR/L3225P12	32	25	170	32	22	28						
	PSBNR/L3232P12	32	32	170	32	29	28						
	PSBNR/L2525M15	25	25	150	25	22	32	SN□□1506□□	VHX0825	PS15476	S3	LV5	SP5
	PSBNR/L3232P15	32	32	170	32	28	32						
	PSBNR/L3232P19	32	32	170	32	36	45						
	PSBNR/L4040S19	40	40	250	40	35	45	SN□□1906□□	VHX1027	PS19476	S4	LV6	SP6
	PSBNR/L4040S2507	40	40	250	40	35	50						
	PSBNR/L4040S2509	40	40	250	40	35	50						
							SN□□2507□□	VHX1236	PS25634	S5	LV8	SP8	
							SN□□2509□□						PS25476

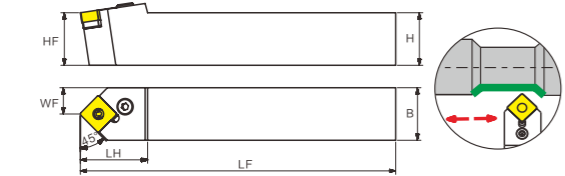

PSDNN	Type	Dimension						Adaptable Inserts	Screw	Shim	Wrench	Lever	Shim Pin
		H	B	LF	HF	WF	LH						
45°	PSDNN2020K12	20	20	125	20	10	30	SN□□1204□□	VHX0821	PS12318	S3	LV4	SP4
	PSDNN2525M12	25	25	150	25	12.5	32						
	PSDNN3232P12	32	32	170	32	16	30						
	PSDNN2525M15	25	25	150	25	12.5	40	SN□□1506□□	VHX0825	PS15476	S3	LV5	SP5
	PSDNN3232P15	32	32	170	32	16	40						
	PSDNN3232P19	32	32	170	32	16	40						
	PSDNN4040S19	40	40	250	40	20	40	SN□□1906□□	VHX1027	PS19476	S4	LV6	SP6
	PSDNN4040S2507	40	40	250	40	20	50						
	PSDNN4040S2509	40	40	250	40	20	50						
								SN□□2507□□	VHX1236	PS25634	S5	LV8	SP8
							SN□□2509□□	PS25476					

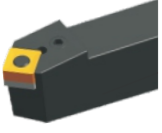

P Type External Turning Tool Holder

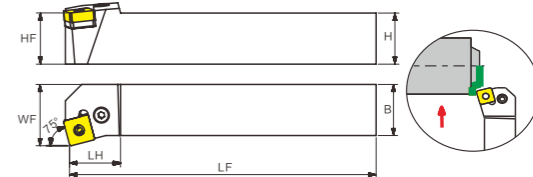

PSKNR/L	Type	Dimension						Adaptable Inserts	Screw	Shim	Wrench	Lever	Shim Pin
		H	B	LF	HF	WF	LH						
75°	PSKNR/L1616H09	16	16	100	16	20	17	SN□□0903□□	VHX0613	PS09318	S2.5	LV3	SP3
	PSKNR/L2020K09	20	20	125	20	25	20						
	PSKNR/L2020K12	20	20	125	20	25	26						
	PSKNR/L2525M12	25	25	150	25	30	26	SN□□1204□□	VHX0821	PS12318	S3	LV4	SP4
	PSKNR/L3232P12	32	32	170	32	38	26						
	PSKNR/L2525M15	25	25	150	25	32	32						
	PSKNR/L3232P15	32	32	170	32	38	32	SN□□1506□□	VHX0825	PS15476	S3	LV5	SP5
	PSKNR/L3232P19	32	32	170	32	38	36						
	PSKNR/L4040S19	40	40	250	40	48	32						
	PSKNR/L4040S2507	40	40	250	40	50	40	SN□□2507□□	VHX1236	PS25634	S5	LV8	SP8
	PSKNR/L4040S2509	40	40	250	40	50	40						

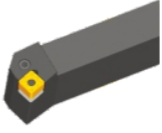

PSSNR/L	Type	Dimension						Adaptable Inserts	Screw	Shim	Wrench	Lever	Shim Pin
		H	B	LF	HF	WF	LH						
45°	PSSNR/L1616H09	16	16	100	16	18	25	SN□□0903□□	VHX0613	PS09318	S2.5	LV3	SP3
	PSSNR/L2020K12	20	20	125	20	25	28						
	PSSNR/L2525M12	25	25	150	25	30	32						
	PSSNR/L3232P12	32	32	170	32	38	32	SN□□1204□□	VHX0821	PS12318	S3	LV4	SP4
	PSSNR/L2525M15	25	25	150	25	30	35						
	PSSNR/L3232P15	32	32	170	32	38	35						
	PSSNR/L2525M15	25	25	150	25	30	35	SN□□1506□□	VHX0825	PS15476	S3	LV5	SP5
	PSSNR/L3232P15	32	32	170	32	38	35						
	PSSNR/L3232P19	32	32	170	32	38	40						
	PSSNR/L4040S19	40	40	250	40	48	50	SN□□1906□□	VHX1027	PS19476	S4	LV6	SP6
	PSSNR/L4040S2507	40	40	250	40	48	50						
	PSSNR/L4040S2509	40	40	250	40	48	50						
							SN□□2507□□	VHX1236	PS25634	S5	LV8	SP8	
							SN□□2509□□						PS25476



P Type External Turning Tool Holder

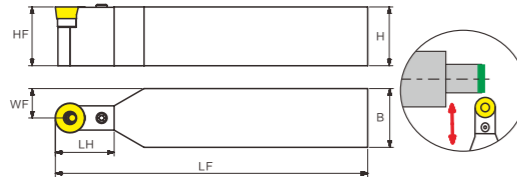

PRDCN	Type	Dimension						Adaptable Inserts	Screw	Shim	Wrench	Lever	Shim Pin
		H	B	LF	HF	WF	LH						
	PRDCN2020K12	20	20	125	20	10	25	RCMX1204□□	VHX0613	PR1204	S2.5	LCL12C	SP3
	PRDCN2525M12	25	25	150	25	12.5	25						
	PRDCN2525M16	25	25	150	25	10	35	RCMX1606□□	VHX0621	PR1604	S2.5	LCL16C	SP4
	PRDCN3232P16	32	32	170	32	16	32						
	PRDCN3232P20	32	32	170	32	16	40	RCMX2006□□	VHX0825	PR2004	S3	LCL20C	SP5
	PRDCN4040T20	40	40	300	40	20	45						
	PRDCN3232P25	32	32	170	32	16	45	RCMX2507□□	VHX1030	PR2506	S4	LCL25C	SP6
	PRDCN4040T25	40	40	300	40	20	50						

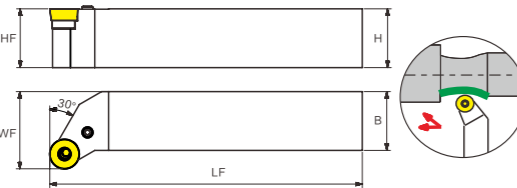

PRGCR/L	Type	Dimension					Adaptable Inserts	Screw	Shim	Wrench	Lever	Shim Pin
		H	B	LF	HF	WF						
	PRGCR/L2020K12	20	20	125	20	25	RCMX1204□□	VHX0613	PR1204	S2.5	LCL12C	SP3
	PRGCR/L2525M12	25	25	150	25	32						
	PRGCR/L2525M16	25	25	150	25	35	RCMX1606□□	VHX0621	PR1604	S2.5	LCL16C	SP4
	PRGCR/L3232P16	32	32	170	32	42						
	PRGCR/L3232P20	32	32	170	32	40	RCMX2006□□	VHX0825	PR2004	S3	LCL20C	SP5
	PRGCR/L4040T20	40	40	300	40	50						
	PRGCR/L3232P25	32	32	170	32	45	RCMX2507□□	VHX1030	PR2506	S4	LCL25C	SP6
	PRGCR/L4040T25	40	40	300	40	56						



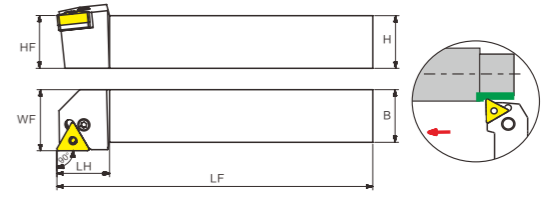





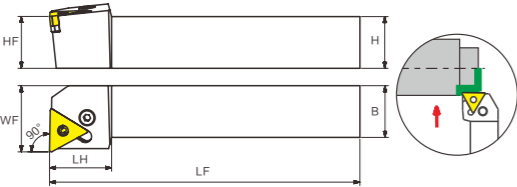









P Type External Turning Tool Holder







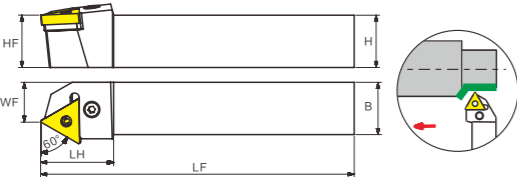

PTGNR/L	Type	Dimension						Adaptable Inserts	Screw	Shim	Wrench	Lever	Shim Pin						
		H	B	LF	HF	WF	LH												
	90°	PTGNR/L1616H11	16	16	100	16	19	18	TN□□1103□□	VHX059B	-	S2	LV2	-					
	PTGNR/L2020K11	20	20	125	20	24	20												
	PTGNR/L2525M11	25	25	150	25	29	20												
	PTGNR/L1616H16	16	16	100	16	19	22	TN□□1604□□	VHX0617	PT16	S2.5	LV3	SP3						
	PTGNR/L2020K16	20	20	125	20	23	25												
	PTGNR/L2525M16	25	25	150	25	29	25												
	PTGNR/L3232P16	32	32	170	32	37	32												
	PTGNR/L2525M22	25	25	150	25	30	30							TN□□2204□□	VHX0821	PT22	S3	LV4	SP4
	PTGNR/L3232P22	32	32	170	32	37	32							TN□□2706□□	VHX0825	PT27	S3	LV5	SP5
	PTGNR/L3232P27	32	32	170	32	37	38												
	PTGNR/L4040S27	40	40	250	40	47	38												

P Type External Turning Tool Holder

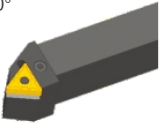









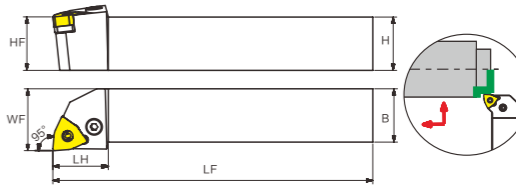





PTFNR/L	Type	Dimension						Adaptable Inserts	Screw	Shim	Wrench	Lever	Shim Pin
		H	B	LF	HF	WF	LH						
	PTFNR/L1616H16	16	16	100	16	20	20						
	PTFNR/L2020K16	20	20	125	20	25	20						
	PTFNR/L2525M16	25	25	150	25	30	25						
	PTFNR/L2525M22	25	25	150	25	32	30						
	PTFNR/L3232P22	32	32	170	32	38	30						
	PTFNR/L3232P27	32	32	170	32	38	35						
PTFNR/L4040S27	40	40	250	40	50	34							



PTTNR/L	Type	Dimension						Adaptable Inserts	Screw	Shim	Wrench	Lever	Shim Pin
		H	B	LF	HF	WF	LH						
	PTTNR/L1616H16	16	16	100	16	13	25						
	PTTNR/L2020K16	20	20	125	20	17	25						
	PTTNR/L2525M25	25	25	150	25	22	32						

P Type External Turning Tool Holder



PWLNR/L	Type	Dimension						Adaptable Inserts	Screw	Shim	Wrench	Lever	Shim Pin
		H	B	LF	HF	WF	LH						
	PWLNR/L1616H06	16	16	100	16	19	22						
	PWLNR/L2020K06	20	20	125	20	23	25						
	PWLNR/L2525M06	25	25	150	25	28	25						
	PWLNR/L2020K08	20	20	125	20	25	26						
	PWLNR/L2525M08	25	25	150	25	29	26						
	PWLNR/L3232P08	32	32	170	32	37	26						

S Type External Turning Tool Holder

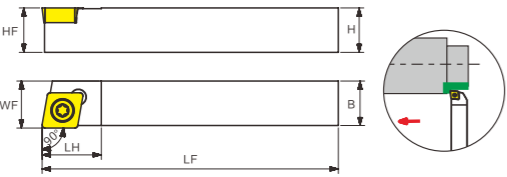

SCACR/L	Type	Dimension						Adaptable Inserts	Screw	Wrench
		H	B	LF	HF	WF	LH			
	SCACR/L1010E06	10	10	70	10	10.5	10		L60M2.5 × 5	T08
	SCACR/L1212F09	12	12	80	12	12.7	16		L60M4 × 8	T15



SCLCR/L	Type	Dimension						Adaptable Inserts	Screw	Wrench
		H	B	LF	HF	WF	LH			
	SCLCR/L1212F09	12	12	80	12	15	16		L60M4 × 8	T15
	SCLCR/L1616H09	16	16	100	16	20	16			
	SCLCR/L2020K09	20	20	125	20	23	20			
	SCLCR/L2020K12	20	20	125	20	24	25		L60M5*12	T20
	SCLCR/L2525M12	25	25	150	25	29	25			
	SCLCR/L3225P12	32	32	170	32	29	25			
	SCLCR/L3232P12	32	32	170	32	36	38			

S Type External Turning Tool Holder

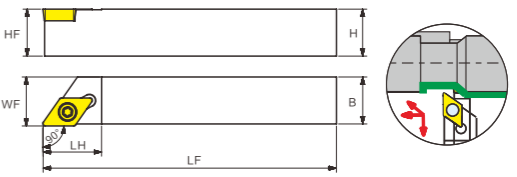

SDACR/L	Type	Dimension						Adaptable Inserts	Screw	Wrench
		H	B	LF	HF	WF	LH			
	SDACR/L1010E07	10	10	70	10	10.5	15		L60M2.5 × 5	T08
	SDACR/L1212F11	12	12	80	12	12.5	20		L60M4 × 8	T15
	SDACR/L1616H11	16	16	100	16	16.7	20			

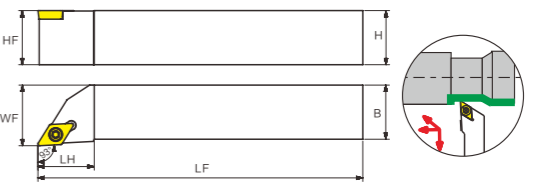

SDJCR/L	Type	Dimension						Adaptable Inserts	Screw	Wrench
		H	B	LF	HF	WF	LH			
	SDJCR/L1010E07	10	10	70	10	12	15		L60M2.5 × 5	T08
	SDJCR/L1212F07	12	12	80	12	14	15			
	SDJCR/L1616H07	16	16	100	16	18	18			
	SDJCR/L2020K07	20	20	125	20	22	18		L60M4 × 8	T15
	SDJCR/L1616H11	16	16	100	16	19	20			
	SDJCR/L2020K11	20	20	125	20	23	26			
	SDJCR/L2525M11	25	25	150	25	28	26			
	SDJCR/L3225P11	32	25	170	32	28	26			
	SDJCR/L3232P11	32	32	170	32	35	31			

S Type External Turning Tool Holder

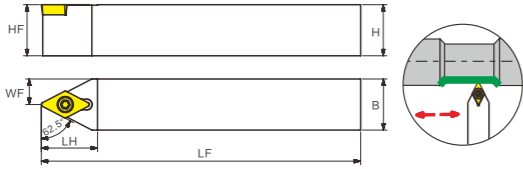

SDNCN	Type	Dimension						Adaptable Inserts	Screw	Wrench
		H	B	LF	HF	WF	LH			
	SDNCN1010E07	10	10	70	10	5	16	DC□T0702□□	L60M2.5 × 5	T08
	SDNCN1212F07	12	12	80	12	6	20			
	SDNCN1212H11	12	12	100	12	6	22	DC□T11T3□□	L60M4 × 8	T15
	SDNCN1616H11	16	16	100	16	8	22			
	SDNCN2020K11	20	20	125	20	10	22			
	SDNCN2525M11	25	25	150	25	12.5	22			

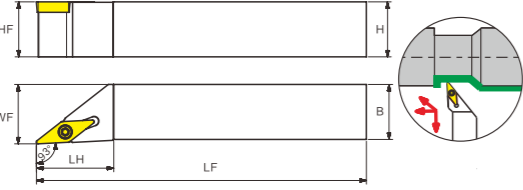

SVJCR/L	Type	Dimension						Adaptable Inserts	Screw	Wrench
		H	B	LF	HF	WF	LH			
	SVJCR/L1212F11	12	12	80	12	14	20	VC□T1103□□	L60M2.5 × 5	T08
	SVJCR/L1616H11	16	16	100	16	18	22			
	SVJCR/L2020K11	20	20	125	20	22	27			
	SVJCR/L2525M11	25	25	150	25	27	35	VC□T1604□□	L60M4 × 8	T15
	SVJCR/L1616H16	16	16	100	16	18	32			
	SVJCR/L2020K16	20	20	125	20	22	32			
	SVJCR/L2525M16	25	25	150	25	27	35			
	SVJCR/L3225P16	32	25	170	32	27	35			
SVJCR/L3232P16	32	32	170	32	35	45				

S Type External Turning Tool Holder

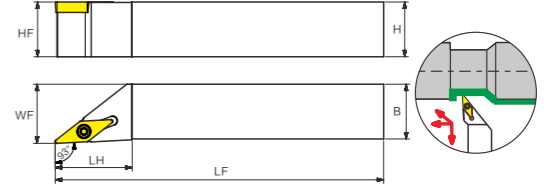

SVJBR/L	Type	Dimension						Adaptable Inserts	Screw	Wrench
		H	B	LF	HF	WF	LH			
	SVJBR/L1212F11	12	12	80	12	14	27	VB□T1103□□	L60M2.5 × 5	T08
	SVJBR/L1616H11	16	16	100	16	18	27			
	SVJBR/L2020K11	20	20	125	20	22	27			
	SVJBR/L2525M11	25	25	150	25	27	27	VB□T1604□□	L60M4 × 8	T15
	SVJBR/L1616H16	16	16	100	16	18	36			
	SVJBR/L2020K16	20	20	125	20	22	41			
	SVJBR/L2525M16	25	25	150	25	27	41			
	SVJBR/L3225P16	32	25	170	32	27	41			
	SVJBR/L3232P16	32	32	170	32	35	41			

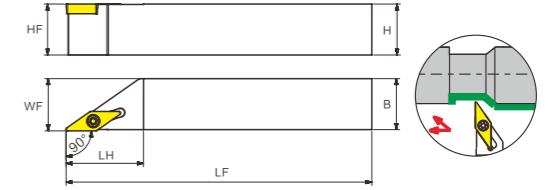

SVABR/L	Type	Dimension						Adaptable Inserts	Screw	Wrench
		H	B	LF	HF	WF	LH			
	SVABR/L1616H16	16	16	100	16	16.5	32	VB□T1604□□	L60M4 × 8	T15
	SVABR/L2020K16	20	20	125	20	20.5	32			
	SVABR/L2525M16	25	25	150	25	25.5	38			

S Type External Turning Tool Holder

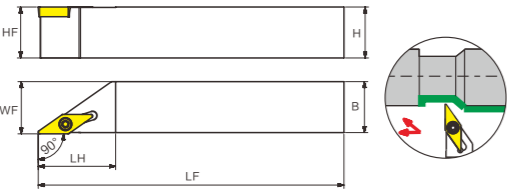

SVACR/L	Type	Dimension						Adaptable Inserts	Screw	Wrench
		H	B	LF	HF	WF	LH			
	SVACR/L1616H16	16	16	100	16	16.5	32	VC□T1604□□	L60M4 × 8	T15
	SVACR/L2020K16	20	20	125	20	20.5	32			
	SVACR/L2525M16	25	25	150	25	25.5	38			

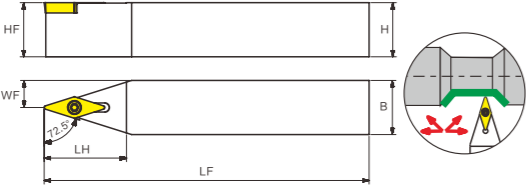

SVVBN	Type	Dimension						Adaptable Inserts	Screw	Wrench
		H	B	LF	HF	WF	LH			
	SVVBN1212F11	12	12	80	12	6	22	VB□T1103□□	L60M2.5 × 5	T08
	SVVBN1616H11	16	16	100	16	8	27			
	SVVBN2020K11	20	20	125	20	10	30			
	SVVBN1616H16	16	16	100	16	8	33	VB□T1604□□	L60M4 × 8	T15
	SVVBN2020K16	20	20	125	20	10	33			
	SVVBN2525M16	25	25	150	25	12.5	38			
	SVVBN3225P16	32	25	170	32	12.5	38			
SVVBN3232P16	32	32	170	32	16	38				

S Type External Turning Tool Holder

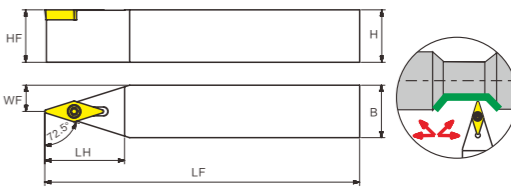

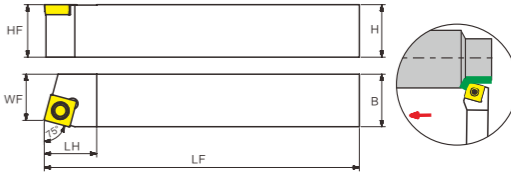

SVVCN	Type	Dimension						Adaptable Inserts	Screw	Wrench
		H	B	LF	HF	WF	LH			
	SVVCN1212F11	12	12	80	12	6	22	VC□T1103□□	L60M2.5 × 5	T08
	SVVCN1616H11	16	16	100	16	8	27			
	SVVCN2020K11	20	20	125	20	10	30			
	SVVCN1616H16	16	16	100	16	8	33	VC□T1604□□	L60M4 × 8	T15
	SVVCN2020K16	20	20	125	20	10	33			
	SVVCN2525M16	25	25	150	25	12.5	38			
	SVVCN3225P16	32	25	170	32	12.5	38			
SVVCN3232P16	32	32	170	32	16	38				

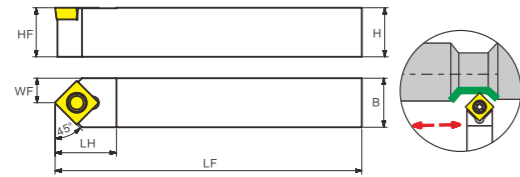

SSBCR/L	Type	Dimension						Adaptable Inserts	Screw	Wrench
		H	B	LF	HF	WF	LH			
	SSBCR/L1212F09	12	12	80	12	11	14	SC□T09T3□□	L60M4 × 8	T15
	SSBCR/L1616H09	16	16	100	16	13	16			
	SSBCR/L2020K12	20	20	125	20	17	25	SC□T1204□□	L60M5 × 12	T20
	SSBCR/L2525M12	25	25	150	25	22	25			
	SSBCR/L3232P12	32	32	170	32	27	28			

S Type External Turning Tool Holder



SSDCN	Type	Dimension						Adaptable Inserts	Screw	Wrench
		H	B	LF	HF	WF	LH			
	SSDCN1212F09	12	12	80	12	6	16	SC□T09T3□□	L60M4 × 8	T15
	SSDCN1616H09	16	16	100	16	8	16			
	SSDCN2020K09	20	20	125	20	10	16			
	SSDCN2525M09	25	25	150	25	12.5	25	SC□T1204□□	L60M5 × 12	T20
	SSDCN2020K12	20	20	125	20	10	25			
	SSDCN2525M12	25	25	150	25	12.5	25			
SSDCN3232P12	32	32	170	32	16	25				

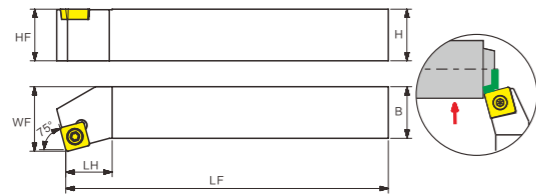

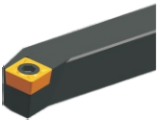
SSKCR/L	Type	Dimension						Adaptable Inserts	Screw	Wrench
		H	B	LF	HF	WF	LH			
	SSKCR/L1616H09	16	16	100	16	20	13	SC□T09T3□□	L60M4 × 8	T15
	SSKCR/L2020K09	20	20	125	20	25	18			
	SSKCR/L2020K12	20	20	125	20	20	18	SC□T1204□□	L60M5 × 12	T20
	SSKCR/L2525M12	25	25	150	25	32	22			
	SSKCR/L3232P12	32	32	170	32	40	27			

S Type External Turning Tool Holder

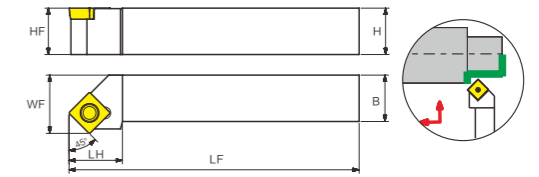

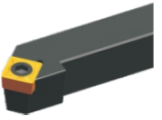
SSSCR/L	Type	Dimension						Adaptable Inserts	Screw	Wrench
		H	B	LF	HF	WF	LH			
	SSSCR/L1616H09	16	16	100	16	20	16	SC□T09T3□□	L60M4 × 8	T15
	SSSCR/L2020K09	20	20	125	20	25	20			
	SSSCR/L2020K12	20	20	125	20	20	23	SC□T1204□□	L60M5 × 12	T20
	SSSCR/L2525M12	25	25	150	25	32	25			
	SSSCR/L3232P12	32	32	170	32	40	28			

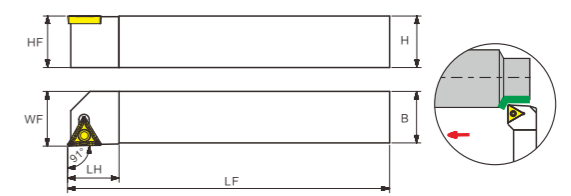

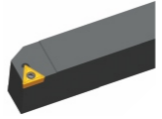
STACR/L	Type	Dimension						Adaptable Inserts	Screw	Wrench
		H	B	LF	HF	WF	LH			
	STACR/L1212F11	12	12	80	12	12.5	14	TC□T1102□□	L60M2.5 × 5	T08

S Type External Turning Tool Holder

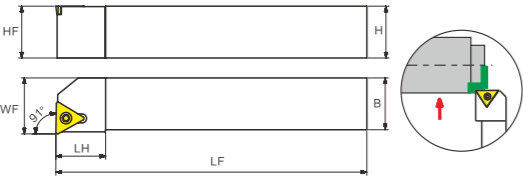

STFCR/L	Type	Dimension						Adaptable Inserts	Screw	Wrench
		H	B	LF	HF	WF	LH			
	STFCR/L1212F11	12	12	80	12	14	14			
	STFCR/L1616H11	16	16	100	16	18	16			
	STFCR/L2020K11	20	20	125	20	22	16			
	STFCR/L1616H16	16	16	100	16	18	19			
	STFCR/L2020K16	20	20	125	20	22	19			
STFCR/L2525M16	25	25	150	25	27	24				

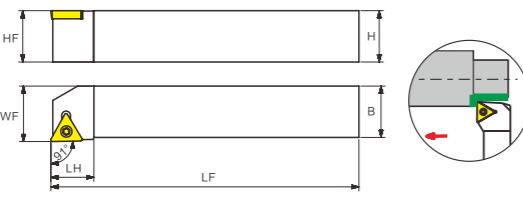

STGCR/L	Type	Dimension						Adaptable Inserts	Screw	Wrench
		H	B	LF	HF	WF	LH			
	STGCR/L0808D09	08	08	60	8	10	11			
	STGCR/L1010E09	10	10	70	10	11	11			
	STGCR/L1212F11	12	12	80	12	14	14			
	STGCR/L1616H11	16	16	100	16	17	16			
	STGCR/L2020K16	20	20	125	20	22	21			
STGCR/L2525M16	25	25	150	25	27	21				

S Type External Turning Tool Holder

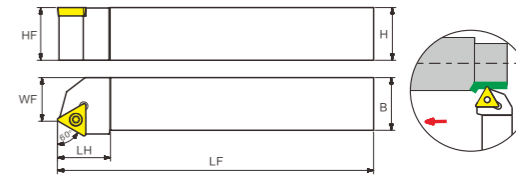

STTCR/L	Type	Dimension						Adaptable Inserts	Screw	Wrench
		H	B	LF	HF	WF	LH			
	STTCR/L1616H11	16	16	100	16	13	14			
	STTCR/L1616H16	16	16	100	16	13	19			
	STTCR/L2020K16	20	20	125	20	17	19			

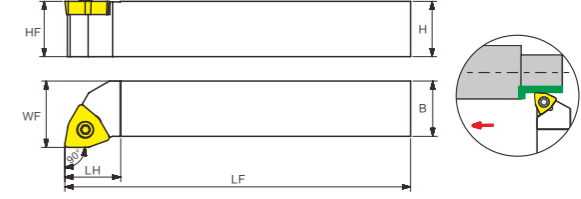

SWACR/L	Type	Dimension						Adaptable Inserts	Screw	Wrench
		H	B	LF	HF	WF	LH			
	SWACR/L1010E04	10	10	70	10	10.5	10			
	SWACR/L1212F04	12	12	80	12	12.5	14			
	SWACR/L1616H06	16	16	100	16	16.5	20			
	SWACR/L2020K08	20	20	125	20	20.5	24			

S Type External Turning Tool Holder

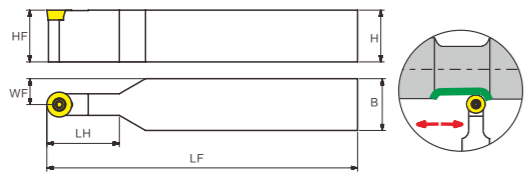

SRDCN	Type	Dimension						Adaptable Inserts	Screw	Wrench	Shim	Shim Screw	Shim Wrench
		H	B	LF	HF	WF	LH						
	SRDCN2020K06	20	20	125	20	10	11	RC□T0602□□	L60M2.5×5	T08	—	—	—
	SRDCN2525M06	25	25	150	25	12.5	11	RC□T0803□□	L60M3×7	T09	—	—	—
	SRDCN2020K08	20	20	125	20	10	16	RC□T10T3□□	L60M3.5×10	T15	—	—	—
	SRDCN2525M08	25	25	150	25	12.5	16	RC□T10T3□□	L60M3.5×10	T15	—	—	—
	SRDCN2020K10	20	20	125	20	10	25	RC□T1204□□	L60M3.5×12	T15	—	—	—
	SRDCN2525M10	25	25	150	25	12.5	25	RC□T1204□□	L60M3.5×12	T15	—	—	—
	SRDCN2020K12	20	20	125	20	10	35	RC□T1606□□	L60M4×16	T20	R16BS	SM0614	S4
	SRDCN2525M12	25	25	150	25	12.5	35	RC□T1606□□	L60M4×16	T20	R16BS	SM0614	S4
	SRDCN3225P12	32	25	170	32	16	35	RCMX2006	L60M5×16-8.1	T20	R20BS	SM0814	S5
	SRDCN2525M16	25	25	150	25	12.5	35	RCMX2006	L60M5×16-8.1	T20	R20BS	SM0814	S5
	SRDCN3232P16	32	32	170	32	16	40	RCMX2006	L60M5×16-8.1	T20	R20BS	SM0814	S5
	SRDCN3232P20	32	32	170	32	16	40	RCMX2006	L60M5×16-8.1	T20	R20BS	SM0814	S5
SRDCN4040S20	40	40	250	40	20	40	RCMX2006	L60M5×16-8.1	T20	R20BS	SM0814	S5	

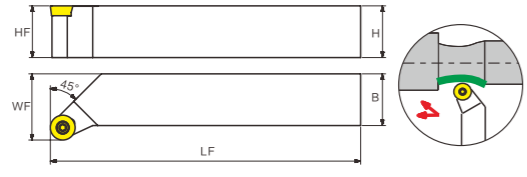

SRGCR/L	Type	Dimension					Adaptable Inserts	Screw	Wrench	Shim	Shim Screw	Shim Wrench
		H	B	LF	HF	WF						
	SRGCR/L2020K10	20	20	125	20	25	RC□T 10T3□□	L60M3.5×10	T15	—	—	—
	SRGCR/L2525M10	25	25	150	25	32	RC□T 1204□□	L60M3.5×12	T15	—	—	—
	SRGCR/L2020K12	20	20	125	20	27	RC□T 1606□□	L60M4×16	T20	R16BS	Sm0614	S4
	SRGCR/L2525M12	25	25	150	25	32	RC□T 1606□□	L60M4×16	T20	R16BS	Sm0614	S4
	SRGCR/L3225P12	32	25	170	32	32	RCMX2006	L60M5×16-8.1	T20	R20BS	SM0814	S5
	SRGCR/L2525M16	25	25	150	25	32	RCMX2006	L60M5×16-8.1	T20	R20BS	SM0814	S5
	SRGCR/L3232P16	32	32	170	32	40	RCMX2006	L60M5×16-8.1	T20	R20BS	SM0814	S5
	SRGCR/L3232P20	32	32	170	32	40	RCMX2006	L60M5×16-8.1	T20	R20BS	SM0814	S5
SRGCR/L4040S20	40	40	250	40	48	RCMX2006	L60M5×16-8.1	T20	R20BS	SM0814	S5	

S Type External Turning Tool Holder

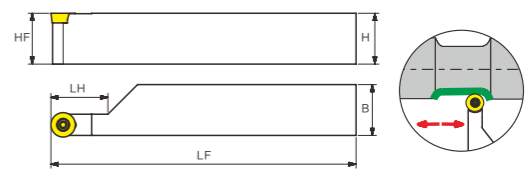

SRACR/L	Type	Dimension					Adaptable Inserts	Screw	Wrench	Shim	Shim Screw	Shim Wrench
		H	B	LF	HF	LH						
	SRACR/L2020K06	20	20	125	20	15	RC□T 0602□□	L60M2.5×5	T08	—	—	—
	SRACR/L2525M06	25	25	150	25	23	RC□T 0803□□	L60M3×7	T09	—	—	—
	SRACR/L2020K08	20	20	125	20	18	RC□T 10T3□□	L60M3.5×10	T15	—	—	—
	SRACR/L2525M08	25	25	150	25	23	RC□T 10T3□□	L60M3.5×10	T15	—	—	—
	SRACR/L2020K10	20	20	125	20	20	RC□T 1204□□	L60M3.5×12	T15	—	—	—
	SRACR/L2525M10	25	25	150	25	25	RC□T 1204□□	L60M3.5×12	T15	—	—	—
	SRACR/L2020K12	20	20	125	20	28	RC□T 1606□□	L60M4×16	T15	R16BS	SM0614	S4
	SRACR/L2525M12	25	25	150	25	28	RC□T 1606□□	L60M4×16	T15	R16BS	SM0614	S4
	SRACR/L3225P12	32	25	170	32	28	RCMX2006	L60M5×16-8.1	T20	R20BS	SM0814	S5
	SRACR/L2525M16	25	25	150	25	35	RCMX2006	L60M5×16-8.1	T20	R20BS	SM0814	S5
	SRACR/L3232P16	32	32	170	32	40	RCMX2006	L60M5×16-8.1	T20	R20BS	SM0814	S5
	SRACR/L3232P20	32	32	170	32	40	RCMX2006	L60M5×16-8.1	T20	R20BS	SM0814	S5
SRACR/L4040S20	40	40	250	40	55	RCMX2006	L60M5×16-8.1	T20	R20BS	SM0814	S5	

Internal Turning Tool Holder Naming Rule

Tool Holder Type

S 25 R - P C L N R 09

代号 Symbol	A	E	C	S	X	
Type of shank	Steel shank+oil cooling hole	Carbide shank+oil cooling hole	Carbide shank	Steel shank	Special insert application	

Tool Holder Diameter

S **25** R - P C L N R 09

Tool holder diameter

Tool Length

S 25 **R** - P C L N R 09

H	K	M	N	Q	R	S	T	U	V
100	125	150	160	180	200	250	300	350	400

Clamping System

S 25 R - **P** C L N R 09

M	P	S
Top and hole clamping	hole clamping	Screw on

Insert Shape

S 25 R - P **C** L N R 09

C	R	T	W	D	S	V

Internal Turning Tool Holder Naming Rule

Tool Holder Style and Leading Angle

S 25 R - P C **L** N R 09

P	U	K	L	F
107.30°	93°	75°	95°	90°

Clearance Angle

S 25 R - P C L **N** R 09

B	C	P	N
5°	7°	11°	0°

Cutting Direction

S 25 R - P C L N **R** 09

R	L

Cutting Edge Length

S 25 R - P C L N R **09**

D	T	C	S	V
35°	60°	80°		35°

M Type Internal Turning Tool Holder

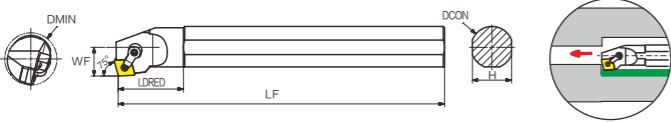

MCKNR/L	Type	Dimension						Adaptable Inserts	Shim	Clamping Stud	Clamp	Clamping Screw	Wrench						
		DMIN	DCON	H	LF	WF	LDRED												
	S20Q-MCKNR/L12	26	20	18	180	14	35												
	S25R-MCKNR/L12	32	25	23	200	16.5	35							X	MSP613	MCL1810	WS061020	S2.5 S3	
	S32S-MCKNR/L12	40	32	30	250	22	50							CN□□1204□□	MC1204	MSP617	MCL1814	WS061025	S3
	S40T-MCKNR/L12	50	40	38	300	26	55												
	S50U-MCKNR/L12	60	50	48	350	30	60												

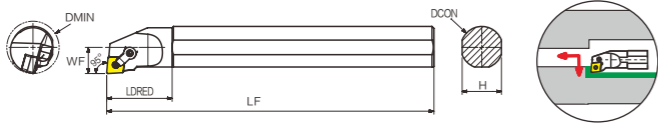

MCLNR/L	Type	Dimension						Adaptable Inserts	Shim	Clamping Stud	Clamp	Clamping Screw	Wrench						
		Dmin	DCON	H	LF	WF	LDRED												
	S20Q-MCLNR/L12	26	20	18	180	13	40												
	S25R-MCLNR/L12	32	25	23	200	16	40							X	MSP613	MCL1810	WS061020	S2.5 S3	
	S32S-MCLNR/L12	40	32	30	250	20	50							CN□□1204□□	MC1204	MSP617	MCL1814	WS061025	S3
	S40T-MCLNR/L12	50	40	37	300	26	55												
	S50U-MCLNR/L12	60	50	46	350	31	70												

M Type Internal Turning Tool Holder

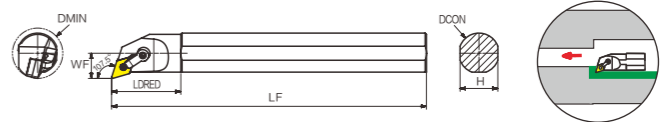



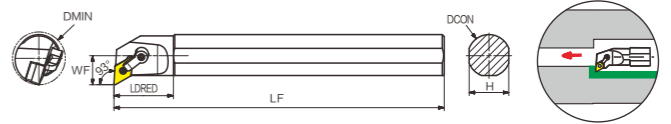

MDQNR/L	Type	Dimension						Adaptable Inserts	Shim	Clamping Stud	Clamp	Clamping Screw	Wrench						
		DMIN	DCON	H	LF	WF	LDRED												
	S20Q-MDQNR/L1504	26	20	18	180	13	40												
	S25R-MDQNR/L1504	32	25	23	200	17	45							X	MSP613	MCL1810	WS061020	S2.5 S3	
	S32S-MDQNR/L1504	40	32	30	250	20	55							DN□□1504□□	MD1504	MSP617	MCL2114	WS061025	S3
	S40T-MDQNR/L1504	50	40	38	300	24	55												
	S32S-MDQNR/L1506	40	32	30	250	20	55							DN□□1506□□	MSP619				
	S40T-MDQNR/L1506	50	40	38	300	24	55												







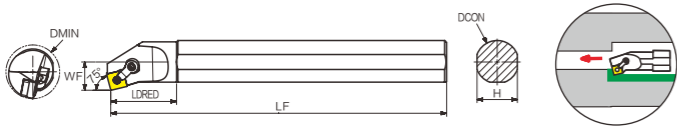

MDUNR/L	Type	Dimension						Adaptable Inserts	Shim	Clamping Stud	Clamp	Clamping Screw	Wrench						
		DMIN	DCON	H	LF	WF	LDRED												
	S20Q-MDUNR/L1504	28	20	18	180	17	40												
	S25R-MDUNR/L1504	32	25	24	200	19	40							X	MSP613	MCL1810	WS061020	S2.5 S3	
	S32S-MDUNR/L1504	40	32	30	250	22	45							DN□□1504□□	MD1504	MSP617	MCL2114	WS061025	S3
	S40T-MDUNR/L1504	50	40	37	300	26	55												
	S32S-MDUNR/L1506	40	32	30	250	22	45							DN□□1506□□	MSP619				
	S40T-MDUNR/L1506	50	40	37	300	26	55												

M Type Internal Turning Tool Holder







MDZNR/L	Type	Dimension								Adaptable Inserts	Shim	Clamping Stud	Clamp	Clamping Screw	Wrench					
		DMIN	DCON	H	LF	WF	LDRED	F2												
	S25R-MDZNR/L1504	36	25	23	200	22	35	11		X	MSP613				S2.5 S3					
	S32S-MDZNR/L1504	43	32	30	250	26	40	12							DN□□1504□□	MD1504	MSP617	MCL1814	WS061025	S3
	S40T-MDZNR/L1504	50	40	37	300	29	50	11.5							DN□□1506□□					
	S32S-MDZNR/L1506	43	32	30	250	26	40	12												
	S40T-MDZNR/L1506	50	40	37	300	29	50	11.5												







MSKNR/L	Type	Dimension								Adaptable Inserts	Shim	Clamping Stud	Clamp	Clamping Screw	Wrench					
		DMIN	DCON	H	LF	WF	θ°	LDRED	F2											
	S20Q-MSKNR/L12	26	20	18	180	13	15°	31		X	MSP613				MCL1810	WS061020				
	S25R-MSKNR/L12	32	25	23	200	17	12°	35							SN□□1204□□	MS1204	MSP617	MCL1814	WS061025	S2.5 S3
	S32S-MSKNR/L12	40	32	30	250	22	17°	40												
	S40T-MSKNR/L12	50	40	37	300	27	15°	50												

M Type Internal Turning Tool Holder







MVQNR/L	Type	Dimension								Adaptable Inserts	Shim	Clamping Stud	Clamp	Clamping Screw	Wrench					
		DMIN	DCON	H	LF	WF	θ°	LDRED	F2											
	S25R-MVQNR/L16	32	25	23	200	17	12°	40		X	MSP510				MCL1814					
	S32S-MVQNR/L16	42	32	30	250	22	17°	40							VN□□1604□□	MV1603	MSP513	MCL2414	WS061025	S2 S3
	S40T-MVQNR/L16	50	40	37	300	27	15°	50												



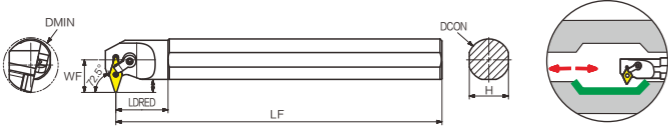



MVUNR/L	Type	Dimension								Adaptable Inserts	Shim	Clamping Stud	Clamp	Clamping Screw	Wrench					
		DMIN	DCON	H	LF	WF	LDRED	F2												
	S25R-MVUNR/L16	36	25	23	200	20	40	8		X	MSP510				MCL1814	WS061025				
	S32S-MVUNR/L16	42	32	30	250	23	40	8							VN□□1604□□	MV1603	MSP513	MCL1814	WS061025	S2 S3
	S40T-MVUNR/L16	50	40	37	300	27	55	10												

M Type Internal Turning Tool Holder







MVWNR/L	Type	Dimension								Adaptable Inserts	Shim	Clamping Stud	Clamp	Clamping Screw	Wrench		
		DMIN	DCON	H	LF	WF	LDRED	F2									
	S25R-MVWNR/L16	36	25	23	200	22	35	10	VN□□1604□□	X	MSP510						
	S32S-MVWNR/L16	48	32	30	250	25	40	10		MV1603	MSP513				MCL1814	WS061025	S2 S3
	S40T-MVWNR/L16	56	40	37	300	29	45	11									



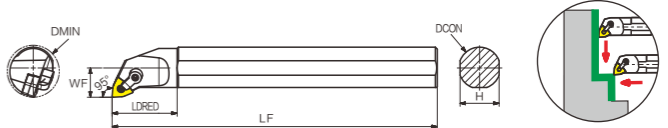



MVXNR/L	Type	Dimension								Adaptable Inserts	Shim	Clamping Stud	Clamp	Clamping Screw	Wrench	
		DMIN	DCON	H	LF	WF	LDRED									
	S25R-MVXNR/L16	32	25	23	200	17	55	VN□□1604□□	X	MSP510						
	S32S-MVXNR/L16	42	32	30	250	21	60		MV1603	MSP513				MCL2414	WS061025	S2 S3
	S40T-MVXNR/L16	50	40	38	300	25	68									

M Type Internal Turning Tool Holder

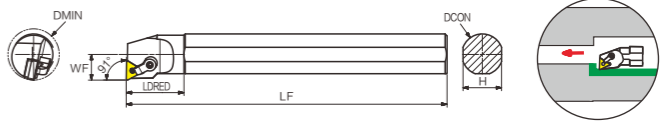



MWLNR/L	Type	Dimension								Adaptable Inserts	Shim	Clamping Stud	Clamp	Clamping Screw	Wrench			
		DMIN	DCON	H	LF	WF	LDRED											
	S20Q-MWLNR/L08	25	20	18	180	14.5	36	WN□□0804□□	X	MSP613								
	S25R-MWLNR/L08	32	25	23	200	17	40							MCL1810	WS061020	S2.5 S3		
	S32S-MWLNR/L08	41	32	30	250	22	50							MW0804	MSP617	MCL1814	WS061025	S3
	S40T-MWLNR/L08	50	40	37	300	27	55											



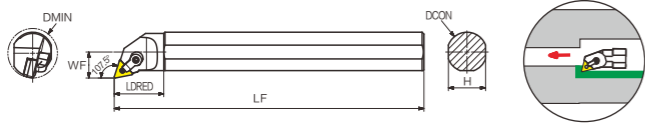

MTFNR/L	Type	Dimension								Adaptable Inserts	Shim	Clamping Stud	Clamp	Clamping Screw	Wrench	
		DMIN	DCON	H	LF	WF	LDRED									
	S20Q-MTFNR/L16	25	20	18	180	13	35	TN□□1604□□	X	MSP510						
	S25R-MTFNR/L16	32	25	23	200	16	40							MCL1810	WS061020	S2 S3
	S32S-MTFNR/L16	40	32	30	250	20	45							MCL1814	WS061025	
	S40T-MTFNR/L16	50	40	37	300	25	50							MT1603	MSP513	

M Type Internal Turning Tool Holder



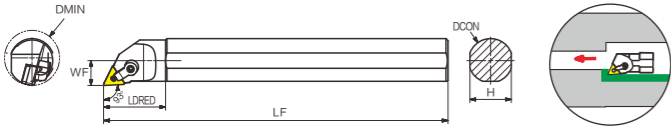

MTQNR/L	Type	Dimension						Adaptable Inserts	Shim	Clamping Stud	Clamp	Clamping Screw	Wrench
		DMIN	DCON	H	LF	WF	LDRED						
 107.5°	S20Q-MTQNR/L16	25	20	18	180	14	35	 TN□□1604□□	X	MSP510	MCL1810	WS061020	S2 S3
	S25R-MTQNR/L16	32	25	23	200	18	35				MCL1814	WS061025	
	S32S-MTQNR/L16	40	32	30	250	21	40		MT1603	MSP513			
	S40T-MTQNR/L16	50	40	37	300	25	50						





MTJNR/L	Type	Dimension						Adaptable Inserts	Shim	Clamping Stud	Clamp	Clamping Screw	Wrench
		DMIN	DCON	H	LF	WF	LDRED						
 93°	S25R-MTJNR/L16	32	25	23	200	15	40	 TN□□1604□□	X	MSP510			S2 S3
	S32S-MTJNR/L16	40	32	30	250	18	45						
	S40T-MTJNR/L16	50	40	37	300	24	55						

M Type Internal Turning Tool Holder



























MTUNR/L	Type	Dimension						Adaptable Inserts	Shim	Clamping Stud	Clamp	Clamping Screw	Wrench
		DMIN	DCON	H	LF	WF	LDRED						
 93°	S20Q-MTUNR/L16	25	20	18	180	13	31	 TN□□1604□□	X	MSP510	MCL1810	WS061020	S2 S3
	S25R-MTUNR/L16	32	25	23	200	17	35				MCL1814	WS061025	
	S32S-MTUNR/L16	40	32	30	250	22	40		MT1603	MSP513			
	S40T-MTUNR/L16	50	40	37	300	23	50						











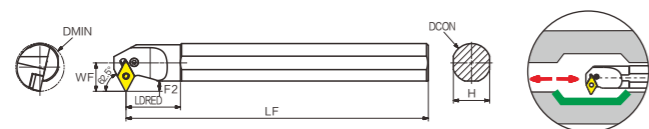





MTWNR/L	Type	Dimension						Adaptable Inserts	Shim	Clamping Stud	Clamp	Clamping Screw	Wrench
		DMIN	DCON	H	LF	WF	LDRED						
 60°	S20Q-MTWNR/L16	27	20	18	180	15	31	 TN□□1604□□	X	MSP510	MCL1810	WS061020	S2 S3
	S25R-MTWNR/L16	32	25	23	200	17	35				MCL1814	WS061025	
	S32S-MTWNR/L16	40	32	30	250	22	42		MT1603	MSP513			
	S40T-MTWNR/L16	50	40	38	300	27	50						

P Type Internal Turning Tool Holder





















PCLNR/L	Type	Dimension								Adaptable Inserts	Screw	Shim	Wrench	Lever	Shim Pin											
		DMIN	DCON	H	LF	WF	θ°	LDRED																		
	S16Q-PCLNR/L09	20	16	15	180	10	-12°	30																		
	S20Q-PCLNR/L09	25	20	18	180	12	-11°	30							CN□□0903□□	VHX0509	—	S2	LV3C	—						
	S25R-PCLNR/L09	32	25	23	200	15	-10°	35																		
	S20Q-PCLNR/L12	25	20	18	180	13	-11°	35	VHX0613	—	S2.5	LV4A	—													
	S25R-PCLNR/L12	32	25	23	200	15	12°	40																		
	S32S-PCLNR/L12	44	32	30	250	22	-10°	50													CN□□1204□□	VHX0821	PC12318	S3	LV4	SP4
	S40T-PCLNR/L12	54	40	37	300	24	-10°	55													VHX0821	PC12318	S3	LV4	SP4	
	S50U-PCLNR/L12	63	50	47	350	27	-10°	58																		
	S50U-PCLNR/L19	63	50	47	350	32	-10°	70							CN□□1906□□	VHX1027	PC19476	S4	LV6	SP6						









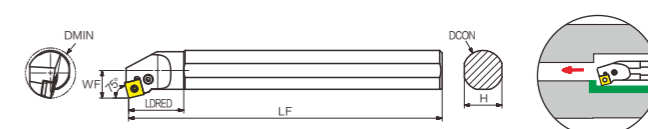

PDSNR/L	Type	Dimension								Adaptable Inserts	Screw	Shim	Wrench	Lever	Shim Pin
		DMIN	DCON	H	LF	WF	LDRED	F2							
	S32S-PDSNR/L15	40	32	30	250	23.5	45	9							
	S40T-PDSNR/L15	50	40	37	300	28.5	43	11							DN□□1506□□
	S32S-PDSNR/L15-3	40	32	30	250	23.5	45	9							
	S40T-PDSNR/L15-3	50	40	37	300	28.5	43	11							DN□□1504□□

P Type Internal Turning Tool Holder



PDUNR/L	Type	Dimension								Adaptable Inserts	Screw	Shim	Wrench	Lever	Shim Pin					
		DMIN	DCON	H	LF	WF	θ°	LDRED												
	S20Q-PDUNR/L11	25	20	18	180	13	-16°	30												
	S25R-PDUNR/L11	32	25	23	200	17	-13°	35							DN□□1104□□	VHX0512	—	S2	LV3D	—
	S32S-PDUNR/L11	40	32	30	250	22	-16°	40												
	S32S-PDUNR/L15	40	32	30	250	22	-16°	50	DN□□1506□□	VHX0821	PD15318	S3	LV4B	SP4						
	S40T-PDUNR/L15	50	40	37	300	27	-11°	50												
	S32S-PDUNR/L15-3	40	32	30	250	22	-16°	50												
	S40T-PDUNR/L15-3	50	40	37	300	27	-11°	50												



PSKNR/L	Type	Dimension								Adaptable Inserts	Screw	Shim	Wrench	Lever	Shim Pin					
		DMIN	DCON	H	LF	WF	θ°	LDRED												
	S25R-PSKNR/L12	32	25	23	200	17	-12°	42												
	S32S-PSKNR/L12	44	32	30	250	22	-10°	45							SN□□1204□□	VHX0613	—	S2.5	LV4A	—
	S40T-PSKNR/L12	54	40	37	300	27	-10°	50							VHX0821	PS12318	S3	LV4	SP4	

P Type Internal Turning Tool Holder

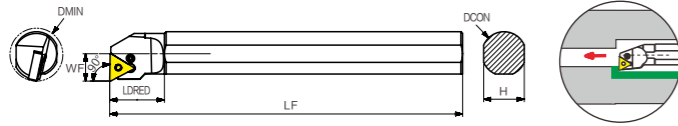

PTFNR/L	Type	Dimension						Adaptable Inserts	Screw	Shim	Wrench	Lever	Cushion Block
		DMIN	DCON	H	LF	WF	LDRED						
	S16Q-PTFNR/L11	20	16	15	180	11	28		VHX0509	—	S2	LV2	—
	S20Q-PTFNR/L11	25	20	18	180	13	31						
	S25R-PTFNR/L11	32	25	23	200	17	35		VHX0512	—	S2	LV3B	—
	S25R-PTFNR/L16	32	25	23	200	17	42						
	S32S-PTFNR/L16	44	32	30	250	22	50						
	S40T-PTFNR/L16	54	40	37	300	27	55						
								VHX0613	PT16476	S2.5	LV3	SP3	



PWLNR/L	Type	Dimension							Adaptable Inserts	Screw	Shim	Wrench	Lever	Cushion Block
		DMIN	DCON	H	LF	WF	θ°	LDRED						
	S16Q-PWLNR/L06	20	16	15	180	11	-13°	25		VHX0512	—	S2	LV3B	—
	S20Q-PWLNR/L06	25	20	18	180	13	-13°	32						
	S25R-PWLNR/L06	32	25	23	200	17	-13°	35						
	S20Q-PWLNR/L08	25	20	18	180	13	-13°	32		VHX0613	—	S2.5	LV4A	—
	S25R-PWLNR/L08	32	25	23	200	17	-13°	45						
	S32S-PWLNR/L08	40	32	30	250	22	-13°	50						
S40T-PWLNR/L08	50	40	42	300	30	-13°	55							
								VHX0821	PW08318	S3	LV4A	SP4		

S Type Internal Turning Tool Holder

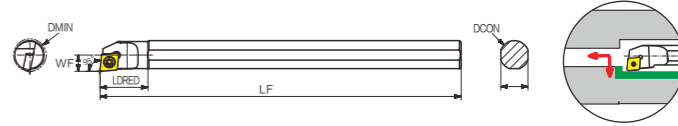



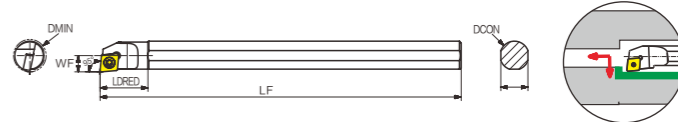



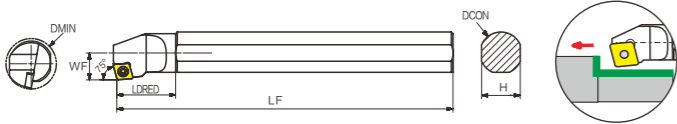

SCLCR/L	Type	Dimension						Adaptable Inserts	Screw	Wrench
		DMIN	DCON	H	LF	WF	LDRED			
	S07K-SCLCR/L06	9	7	6	125	4.6	15		L60M2.5×5	T08
	S08K-SCLCR/L06	10	8	7	125	4.5	14			
	S10K-SCLCR/L06	12	10	9	125	6	17			
	S12M-SCLCR/L06	16	12	11	150	7	17			
	S12M-SCLCR/L09	16	12	11	150	8	25		L60M4×8	T15
	S16Q-SCLCR/L09	20	16	15	180	9	27			
	S20Q-SCLCR/L09	25	20	18	180	11	28			
	S25R-SCLCR/L09	32	25	23	200	14	35			
	S25R-SCLCR/L12	32	25	23	250	17	34		L60M5×12	T20
	S32S-SCLCR/L12	36	32	30	250	18	45			
S40T-SCLCR/L12	50	40	37	300	27	60				









SCLCR/L-H	Type	Dimension							Adaptable Inserts	Screw	Wrench
		DMIN	DCON	H	LF	WF	θ°	LDRED			
	S08K-SCLCR/L06H09	9	8	7	125	4.3	-15°	15		L60M2.5×5	T08
	S10K-SCLCR/L06H09	11	10	9	125	5.5	-15°	16			
	S12M-SCLCR/L06H09	13	12	11	150	6.5	-10°	17			
	S16Q-SCLCR/L09H09	17	16	15	180	8.5	-12°	27			
										L60M4×8	T15

S Type Internal Turning Tool Holder









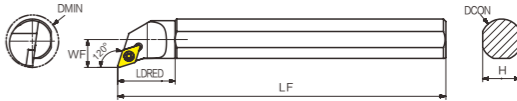

SCKCR/L	Type	Dimension							Adaptable Inserts	Screw	Wrench	
		DMIN	DCON	H	LF	WF	θ°	LDRED				
	75°	S08K-SCKCR/L06	10	8	7.5	125	5.5	13°	15			
		S10K-SCKCR/L06	13	10	9	125	7	12°	15			
		S12M-SCKCR/L06	16	12	11	150	8	10°	20			
		S12M-SCKCR/L09	16	12	11	150	8	12°	20			
		S16Q-SCKCR/L09	20	16	15	160	10	10°	25			
		S20Q-SCKCR/L09	24	20	19	180	13	8°	30			
		S25R-SCKCR/L09	31	26	24	200	16	8°	35			









SDQCR/L	Type	Dimension							Adaptable Inserts	Screw	Wrench	
		DMIN	DCON	H	LF	WF	θ°	LDRED				
	107.5°	S08K-SDQCR/L07	10	8	7	125	6	-8°				
		S10K-SDQCR/L07	13	10	9	150	7	-8°	20			
		S12M-SDQCR/L07	16	12	11	150	9	-8°	22			
		S16Q-SDQCR/L07	20	16	15	180	11	-6°	27			
		S20Q-SDQCR/L11	25	20	18	180	13	-6°	35			
		S25R-SDQCR/L11	32	26	23	200	17	-6°	38			

S Type Internal Turning Tool Holder



SDXCR	Type	Dimension							Adaptable Inserts	Screw	Wrench	
		DMIN	DCON	H	LF	WF	θ°	LDRED				
	120°	S10K-SDXCR/07	13	10	9	125	7	-8°	18			
		S12M-SDXCR/07	16	12	11	150	8	-8°	20			
		S16Q-SDXCR/07	20	16	15	180	10	-6°	25			
		S20Q-SDXCR/11	25	20	18	180	13	-6°	33			
		S25R-SDXCR/11	32	25	23	200	16	-6°	32			



SDWCR/L	Type	Dimension								Adaptable Inserts	Screw	Wrench	
		DMIN	DCON	H	LF	WF	θ°	LDRED	F2				
	62.5°	S12M-SDWCR/L07	19	12	11	125	11	-8°	15	5.5			
		S16Q-SDWCR/L07	23	16	15	180	12.5	-8°	15	5			
		S20Q-SDWCR/L07	27	20	19	180	14.5	-8°	22	5.5			
		S20Q-SDWCR/L11	27	20	19	180	14.5	-6°	25	6			
		S25R-SDWCR/L11	32	25	24	200	18	-6°	25	7			
		S32S-SDWCR/L11	40	32	30	250	21.5	-6°	40	6.5			

S Type Internal Turning Tool Holder

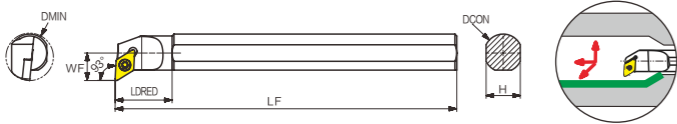

SDUCR/L	Type	Dimension									Adaptable Inserts	Screw	Wrench
		DMIN	DCON	H	LF	WF	θ°	LDRED	F2				
	S08K-SDUCR/L07	13	8	7.5	125	8	-8°		4				
	S10K-SDUCR/L07	13	10	9	125	7.7	-8°		3				
	S12M-SDUCR/L07	16	12	11	150	8.5	-8°		22				3
	S16Q-SDUCR/L07	20	16	15	180	11	-6°		27	3.5			
	S20Q-SDUCR/L11	25	20	18	180	14.5	-6°		30	5.5			
	S25R-SDUCR/L11	32	25	23	200	18.5	-6°		35	7			

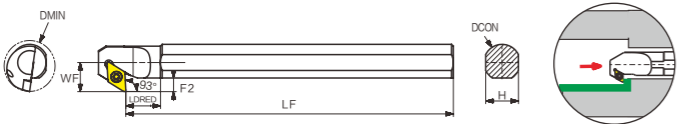

SDZCR/L	Type	Dimension									Adaptable Inserts	Screw	Wrench
		DMIN	DCON	H	LF	WF	θ°	LDRED	F2				
	S20Q-SDZCR/L11	27	20	18	180	15	-6°		20	7.5			
	S25R-SDZCR/L11	33	25	23	200	17	-6°		30	7.5			
	S32S-SDZCR/L11	40	32	30	250	22	-6°		35	8.4			
	S40T-SDZCR/L11	50	40	37	300	27	-4°		50	9.4			

S Type Internal Turning Tool Holder

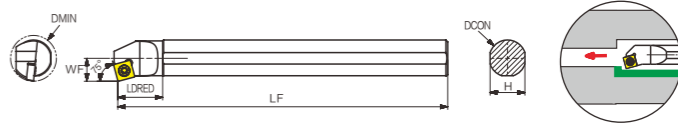

SSKCR/L	Type	Dimension								Adaptable Inserts	Screw	Wrench
		DMIN	DCON	H	LF	WF	θ°	LDRED				
	S12M-SSKCR/L09	16	12	11	150	9	-10°		25			
	S16Q-SSKCR/L09	20	16	15	180	11	-11°		30			
	S20Q-SSKCR/L09	25	20	18	180	13	-6°		35			
	S25R-SSKCR/L09	32	25	23	200	17	-8°		40			
	S25R-SSKCR/L12	32	25	23	200	17	-8°		40			
	S32S-SSKCR/L12	40	32	30	250	22	-10°		45			

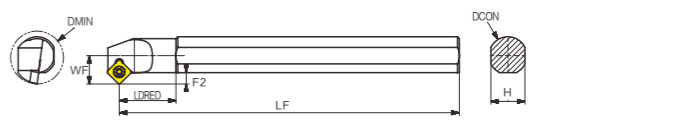

SSSCR/L	Type	Dimension									Adaptable Inserts	Screw	Wrench
		DMIN	DCON	H	LF	WF	θ°	LDRED	F2				
	S12M-SSSCR/L09	17	12	11	150	10	-10°		15	4.5			
	S16Q-SSSCR/L09	22	16	15	180	13	-11°		25	5.5			
	S20Q-SSSCR/L09	25	20	18	180	15	-6°		30	6			
	S25R-SSSCR/L09	32	25	23	200	17	-8°		35	5.5			
	S25R-SSSCR/L12	32	25	23	200	17	-8°		35	5.5			
	S32S-SSSCR/L12	40	32	30	250	22	-10°		40	7			

S Type Internal Turning Tool Holder

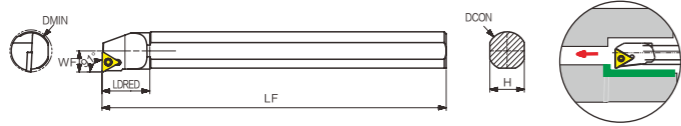

STFCR/L	Type	Dimension						Adaptable Inserts	Screw	Wrench
		DMIN	DCON	H	LF	WF	LDRED			
	S08K-STFCR/L09	10	8	7	125	5.5	8	TC□T0902□□	L60M2.5×5	T08
	S10K-STFCR/L09	12	10	9	125	6.8	10			
	S12M-STFCR/L09	16	12	11	150	8	10			
	S12M-STFCR/L11	14	12	11	150	6.5	25	TC□T1102□□	L60M2.5×5	T08
	S16Q-STFCR/L11	18	16	15	180	9	25			
	S20Q-STFCR/L11	25	20	18	180	11	25			
	S25R-STFCR/L16	32	25	23	200	17	40	TC□T16T3□□	L60M4×8	T15
	S32S-STFCR/L16	36	32	30	250	18	50			
S40T-STFCR/L16	50	40	37	300	25	60				

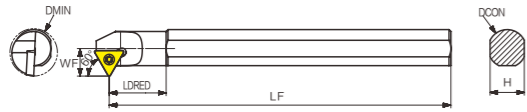

STWCR/L	Type	Dimension						Adaptable Inserts	Screw	Wrench	
		DMIN	DCON	H	LF	WF	θ°				LDRED
	S10K-STWCR/L11	14	10	9	125	8	-10°	14	TC□T1102□□	L60M2.5×5	T08
	S12M-STWCR/L11	16	12	11	150	9	-13°	25			
	S16Q-STWCR/L11	20	16	15	180	11	-10°	30			
	S20Q-STWCR/L11	25	20	19	180	13	-6°	30	TC□T16T3□□	L60M4×8	T15
	S25R-STWCR/L11	32	25	24	200	17	-6°	35			
	S20Q-STWCR/L16	25	20	19	180	14.5	-3°	36			
	S25R-STWCR/L16	32	25	24	200	17	-6°	49	TC□T16T3□□	L60M4×8	T15
	S32S-STWCR/L16	39	32	30	250	22	-10°	50			
S40T-STWCR/L16	50	40	38	300	25	-8°	50				

S Type Internal Turning Tool Holder

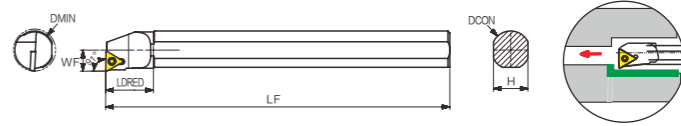

STFPR/L	Type	Dimension						Adaptable Inserts	Screw	Wrench	
		DMIN	DCON	H	LF	WF	θ°				LDRED
	S08K-STFPR/L09	10	08	7	125	5	-10°	14	TP□T0902□□	L60M2.5×5	T08
	S10K-STFPR/L11H11	11	10	9	125	5.5	-13°				
	S12M-STFPR/L11H13	13	12	11	150	6.8	-10°		TP□T1103□□	L60M2.5×5	T08
	S16Q-STFPR/L11H17	17	16	15	180	8.8	-6°				

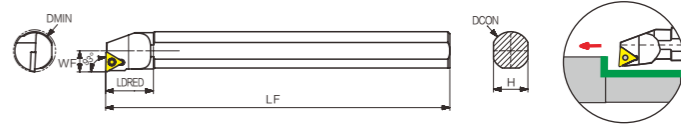

STUCR/L	Type	Dimension						Adaptable Inserts	Screw	Wrench	
		DMIN	DCON	H	LF	WF	θ°				LDRED
	S08K-STUCR/L09	11	08	7	125	5.5	-15°		TC□T0902□□	L60M2.2×6	T06
	S08K-STUCR/L09-A16	11	16	15	125	5.5	-15°	24			
	S10K-STUCR/L09	13	10	9	125	6	-13°	10			
	S10K-STUCR/L09-A16	13	16	15	125	7	-13°	30	TC□T1102□□	L60M2.5×5	T08
	S10K-STUCR/L11	13	10	9	125	7	-12°	10			
	S10K-STUCR/L11-A16	16	16	15	125	7	-12°	30			
	S12M-STUCR/L11	16	12	11	150	7	-10°	25	TC□T1102□□	L60M2.5×5	T08
	S12M-STUCR/L11-A16	16	16	15	150	7	-10°	30			
	S16Q-STUCR/L11	20	16	15	160	9	-8°	25			
	S20Q-STUCR/L11	25	20	19	180	11	-6°	25	TC□T16T3□□	L60M4×8	T15
	S25R-STUCR/L11	31	25	24	200	15	-4°	34			
	S20Q-STUCR/L16	25	20	19	180	13	-8°	36			
S25R-STUCR/L16	31	25	24	200	17	-6°	40	TC□T16T3□□	L60M4×8	T15	
S32S-STUCR/L16	39	32	30	250	18	-4°	50				
S40T-STUCR/L16	50	40	38	300	25	-2°	60				

S Type Internal Turning Tool Holder

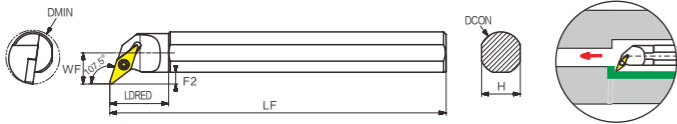

SVQCR/L	Type	Dimension									Adaptable Inserts	Screw	Wrench
		DMIN	DCON	H	LF	WF	θ°	LDRED	F2				
	S20Q-SVQCR/L16	27	20	18	180	15	-8°	40	6.0	VC□T1604□□	L60M4 × 8	T15	
	S25S-SVQCR/L16	32	25	23	200	18.5	-8°	45	6.9				
	S32S-SVQCR/L16	40	32	30	250	22	-8°	56	8.4				
	S40T-SVQCR/L16	50	40	37	300	27	-8°	64	9.4				

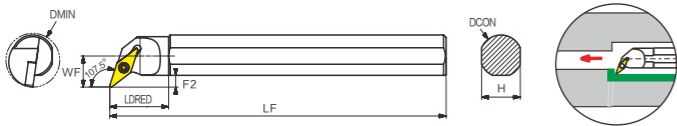

SVQBR/L	Type	Dimension									Adaptable Inserts	Screw	Wrench
		DMIN	DCON	H	LF	WF	θ°	LDRED	F2				
	S20Q-SVQBR/L16	27	20	18	180	15	-8°	40	6.0	VB□T1604□□	L60M4 × 8	T15	
	S25S-SVQBR/L16	32	25	23	200	18.5	-8°	45	6.9				
	S32S-SVQBR/L16	40	32	30	250	22	-8°	56	8.4				
	S40T-SVQBR/L16	50	40	37	300	27	-8°	64	9.4				

S Type Internal Turning Tool Holder

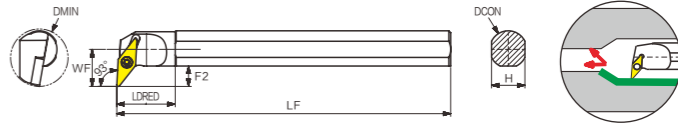

SVUCR/L	Type	Dimension								Adaptable Inserts	Screw	Wrench
		DMIN	DCON	H	LF	WF	LDRED	F2				
	S16Q-SVUCR/L11	22	16	15	180	13.5	24	6	VC□T1103□□	L60M2.5 × 5	T08	
	S20Q-SVUCR/L16	31	20	19	180	19	32	9.5	VC□T1604□□	L60M4 × 8	T15	
	S25R-SVUCR/L16	35	25	23	180	20	32	8.4				
	S32S-SVUCR/L16	42	32	30	250	22	49	8.4				
	S40T-SVUCR/L16	51	40	37	300	27	49	11				

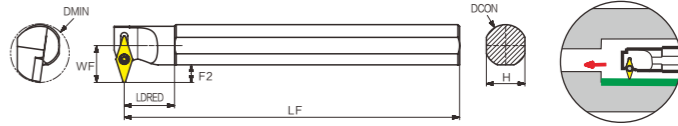

SVWCR/L	Type	Dimension								Adaptable Inserts	Screw	Wrench
		DMIN	DCON	H	LF	WF	LDRED	F2				
	S16Q-SVWCR/L11	25	16	15	180	14	25	6.9	VC□T1103□□	L60M2.5 × 5	T08	
	S20Q-SVWCR/L16	32	20	18	180	22	25	12.9	VC□T1604□□	L60M4 × 8	T15	
	S25R-SVWCR/L16	36	25	23	200	22	30	10				
	S32S-SVWCR/L16	45	32	30	250	27	42	12.2				
	S40T-SVWCR/L16	55	40	37	300	30	50	11				

S Type Internal Turning Tool Holder

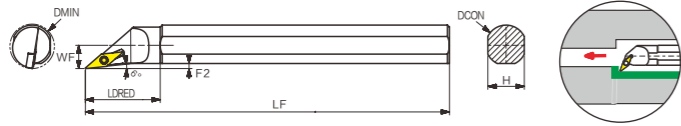

SVXCR/L	Type	Dimension							Adaptable Inserts	Screw	Wrench
		DMIN	DCON	H	LF	WF	LDRED	F2			
	S16Q-SVXCR/L11	20	16	15	180	9.5	35	2	VC□T1103□□	L60M2.5×5	T08
	S20Q-SVXCR/L16	25	20	18	180	13	40	4			
	S25R-SVXCR/L16	32	25	23	180	14.5	40	3	VC□T1604□□	L60M4×8	T15
	S32S-SVXCR/L16	40	32	30	250	21	62	6			
	S40T-SVXCR/L16	50	40	37	300	24	62	5.5			

S Type Internal Turning Tool Holder

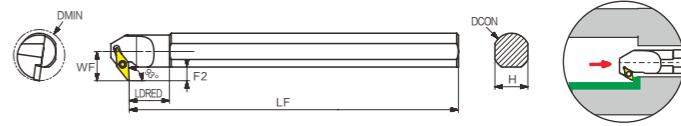

SVZCR/L	Type	Dimension							Adaptable Inserts	Screw	Wrench
		DMIN	DCON	H	LF	WF	LDRED	F2			
93° 	S16Q-SVZCR/L11	22	16	15	180	13.5	15	6.5	VC□T1103□□	L60M2.5×5	T08
	S20Q-SVZCR/L11	28	20	18	180	16	22	7.5			
	S25R-SVZCR/L16	34	25	23	200	21	30	10	VC□T1604□□	L60M4×8	T15
	S32S-SVZCR/L16	42	32	30	250	23	35	9			
	S40T-SVZCR/L16	50	40	37	300	29	40	11			

Parting and Grooving Holder Naming Rule

External and End Face Parting and Grooving Cutting Tools

Q F G D 25 25 R 22 52 H

Q	F	G	D	25	25	R	22	52	H
Application code Q:parting and grooving P:part off	Cutting application E:external cutting F:end face cutting	Positioning slot code	Cutting edge number S:single head D:double heads	Tool body height	Tool body width	Cutting direction R:right L:left N:neutral	Max cutting depth	The minimum diameter for initial end face cutting	End face cutting shank type: H: straight L: bend

Grooving Tool

C 32 S - Q G D R 11 - 44

C	32	S	Q	G	D	R	11	44
Clamp type	Holder diameter	Holder length	Application code	Positioning slot code	Cutting edge number	Cutting direction (R:right L:left)	Max cutting depth	Min diameter

Part off Blade

P H S 32 32

P	H	S	32	32
Parting off cutting tools	Parting off tool base	Cutting edges numbers of insert	Blade model code	Blade height

External and End Face Parting and Grooving Cutting Tools

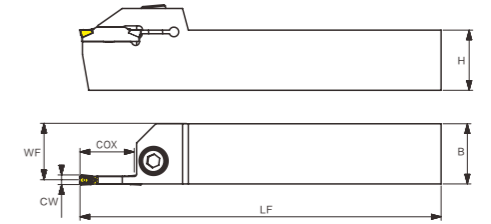

Type	Dimension					Adaptable Inserts	Screw	Wrench
	HxB	LF	WF	CW	CDX			
QEED	1616R/L10	16x16	100	15	2.5	10	M6 × 20	S5
	1616R/L17	16x16	100	15	2.5	17		
	2020R/L10	20x20	125	19	2.5	10		
	2020R/L17	20x20	125	19	2.5	17		
	2525R/L10	25x25	150	24	2.5	10		
QEFD	1616R/L10	16x16	100	14.8	3	10	M6 × 20	S5
	1616R/L17	16x16	100	14.8	3	17		
	2020R/L10	20x20	125	18.8	3	10		
	2020R/L17	20x20	125	18.8	3	17		
	2525R/L10	25x25	150	23.8	3	10		
QEGD	2020R/L13	20x20	140	18.5	4	13	M6 × 20	S5
	2020R/L22	20x20	140	18.5	4	22		
	2525R/L13	25x25	150	23.5	4	13		
	2525R/L22	25x25	150	23.5	4	22		
	3232R/L13	32x32	170	30.5	4	13		
QEHD	2525R/L13	25x25	150	23	5	13	M6 × 20	S5
	2525R/L22	25x25	150	23	5	22		
QEHS	2525N30	25x25	150	12.5	5	30	M6 × 20	S5
QEHD	3232R/L13	32x32	170	30	5	13		
QEHD	3232R/L22	32x32	170	30	5	22	M6 × 20	S5
	QEHS	3232N30	32x32	170	16	5		
QEKD	2525R/L13	25x25	150	22.6	6	13	M6 × 20	S5
	2525R/L22	25x25	150	22.6	6	22		
QEKS	2525N30	25x25	150	12.5	6	30	M6 × 20	S5
QEKD	3232R/L13	32x32	170	29.6	6	13		
QEKD	3232R/L22	32x32	170	29.6	6	22	M6 × 20	S5
	QEKS	3232N30	32x32	170	16	6		



End Face Grooving and Turning Holders

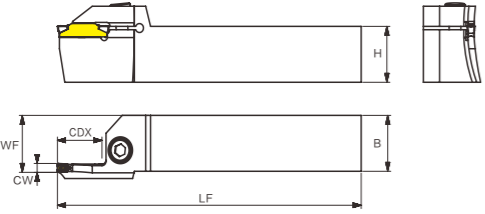

Type	Dimension							Adaptable Inserts	Screw	Wrench
	HxB	LF	WF	CW	CDX	φ D				
QFFD	2525RL10-48H	25x25	150	26	3	10	48-66	QTFD0303-MG	M6 × 20	S5
	2525RL17-48H	25x25	150	26	3	17	48-66	QTFD0303-MG		
	2525RL10-60H	25x25	150	26	3	10	60-80	QTFD0303-MG		
	2525RL17-60H	25x25	150	26	3	17	60-80	QTFD0303-MG		
	2525RL10-74H	25x25	150	26	3	10	74-110	QTFD0303-MG		
	2525RL17-74H	25x25	150	26	3	17	74-110	QTFD0303-MG		
	2525RL10-100H	25x25	150	26	3	10	100-150	QTFD0303-MG		
	2525RL17-100H	25x25	150	26	3	17	100-150	QTFD0303-MG		
QFGD	2525RL13-52H	25x25	150	26	4	13	52-72	QTGD0404-MG		
	2525RL22-52H	25x25	150	26	4	22	52-72	QTGD0404-MG		
	2525RL13-64H	25x25	150	26	4	13	64-100	QTGD0404-MG		
	2525RL22-64H	25x25	150	26	4	22	64-100	QTGD0404-MG		
	2525RL13-90H	25x25	150	26	4	13	90-140	QTGD0404-MG		
	2525RL22-90H	25x25	150	26	4	22	90-140	QTGD0404-MG		
	2525RL13-130H	25x25	150	26	4	13	130-230	QTGD0404-MG		
	2525RL22-130H	25x25	150	26	4	22	130-230	QTHD0404-MG		
QFHD	2525RL13-58H	25x25	150	26	5	13	58-96	QTHD0404-MG		
	2525RL22-58H	25x25	150	26	5	22	58-96	QTHD0404-MG		
	2525RL13-86H	25x25	150	26	5	13	86-140	QTHD0404-MG		
	2525RL22-86H	25x25	150	26	5	22	86-140	QTHD0404-MG		
	2525RL13-130H	25x25	150	26	5	13	130-200	QTHD0404-MG		
	2525RL22-130H	25x25	150	26	5	22	130-200	QTHD0404-MG		
	2525RL13-185H	25x25	150	26	5	13	185-400	QTHD0404-MG		
	2525RL22-185H	25x25	150	26	5	22	185-400	QTHD0404-MG		
QFKD	2525RL30-185H	25x25	150	26	6	30	185-400	QTKD0608-MG		
	2525RL13-60H	25x25	150	26	6	13	60-100	QTKD0608-MG		
	2525RL22-60H	25x25	150	26	6	22	60-100	QTKD0608-MG		
	2525RL13-88H	25x25	150	26	6	13	88-180	QTKD0608-MG		
	2525RL22-88H	25x25	150	26	6	22	88-180	QTKD0608-MG		
	2525RL13-160H	25x25	150	26	6	13	160-400	QTKD0608-MG		
	2525RL22-160H	25x25	150	26	6	22	160-400	QTKD0608-MG		
	2525RL30-160H	25x25	150	26	6	30	160-400	QTKD0608-MG		



End Face Grooving and Turning Holders

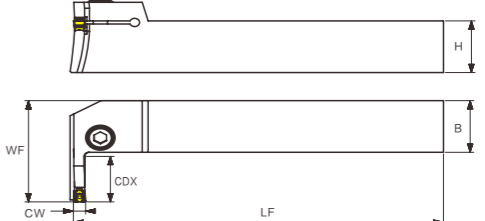

Type	Dimension							Adaptable Inserts	Screw	Wrench
	HxB	LF	WF	CW	CDX	φ D				
QFFD	2525RL10-48L	25x25	150	36.5	3	10	48-66	QTFD0303-MG	M6 × 20	S5
	2525RL17-48L	25x25	150	43.5	3	17	48-66	QTFD0303-MG		
	2525RL10-60L	25x25	150	36.5	3	10	60-80	QTFD0303-MG		
	2525RL17-60L	25x25	150	43.5	3	17	60-80	QTFD0303-MG		
	2525RL10-74L	25x25	150	36.5	3	10	74-110	QTFD0303-MG		
	2525RL17-74L	25x25	150	43.5	3	17	74-110	QTFD0303-MG		
	2525RL10-100L	25x25	150	36.5	3	10	100-150	QTFD0303-MG		
	2525RL17-100L	25x25	150	43.5	3	17	100-150	QTFD0303-MG		
QFGD	2525RL13-52L	25x25	150	39.5	4	13	52-72	QTGD0404-MG		
	2525RL22-52L	25x25	150	48.5	4	22	52-72	QTGD0404-MG		
	2525RL13-64L	25x25	150	39.5	4	13	64-100	QTGD0404-MG		
	2525RL22-64L	25x25	150	48.5	4	22	64-100	QTGD0404-MG		
	2525RL13-90L	25x25	150	39.5	4	13	90-140	QTGD0404-MG		
	2525RL22-90L	25x25	150	48.5	4	22	90-140	QTGD0404-MG		
	2525RL13-130L	25x25	150	39.5	4	13	130-230	QTGD0404-MG		
	2525RL22-130L	25x25	150	48.5	4	22	130-230	QTHD0404-MG		
QFHD	2525RL13-58L	25x25	150	39.5	5	13	58-96	QTHD0504-MG		
	2525RL22-58L	25x25	150	48.5	5	22	58-96	QTHD0504-MG		
	2525RL13-86L	25x25	150	39.5	5	13	86-140	QTHD0504-MG		
	2525RL22-86L	25x25	150	48.5	5	22	86-140	QTHD0504-MG		
	2525RL13-130L	25x25	150	39.5	5	13	130-200	QTHD0504-MG		
	2525RL22-130L	25x25	150	48.5	5	22	130-200	QTHD0504-MG		
	2525RL13-185L	25x25	150	39.5	5	13	185-400	QTHD0504-MG		
	2525RL22-185L	25x25	150	48.5	5	22	185-400	QTHD0504-MG		
QFKD	2525RL30-185L	25x25	150	56.5	6	30	185-400	QTKD0608-MG		
	2525RL13-60L	25x25	150	39.5	6	13	60-100	QTKD0608-MG		
	2525RL22-60L	25x25	150	48.5	6	22	60-100	QTKD0608-MG		
	2525RL13-88L	25x25	150	39.5	6	13	88-180	QTKD0608-MG		
	2525RL22-88L	25x25	150	48.5	6	22	88-180	QTKD0608-MG		
	2525RL13-160L	25x25	150	39.5	6	13	160-400	QTKD0608-MG		
	2525RL22-160L	25x25	150	48.5	6	22	160-400	QTKD0608-MG		
	2525RL30-160L	25x25	150	56.5	6	30	160-400	QTKD0608-MG		

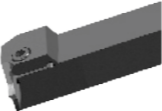

ZQ

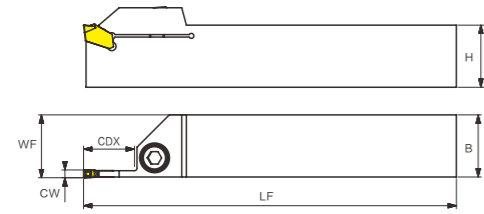

Type	Dimension							Adaptable Inserts	Screw	Wrench
	H	B	LF	WF	CW	CDX				
ZQ1616R03	16	16	100	16.4	3	16	ZQMX3N11-1E	M5 × 17	S4	
ZQ1616R04	16	16	100	16.4	4	18				ZQMX4N11-1E
ZQ2020R03	20	20	125	20.4	3	20	ZQMX3N11-1E	M6 × 20	S5	
ZQ2020R04	20	20	125	20.4	4	20	ZQMX4N11-1E			
ZQ2525R03	25	25	150	25.4	3	20	ZQMX3N11-1E			
ZQ2525R04	25	25	150	25.4	4	20	ZQMX4N11-1E			
ZQ2525R05	25	25	150	25.4	5	25	ZQMX5N11-1E			
ZQ2525R06	25	25	150	25.7	6	32	ZQMX6N11-1E			
ZQ3225R03	32	25	170	25.4	3	25	ZQMX3N11-1E	M6 × 22	S5	
ZQ3225R04	32	25	170	25.4	4	25	ZQMX4N11-1E			
ZQ3225R05	32	25	170	25.4	5	25	ZQMX5N11-1E			
ZQ3225R06	32	25	170	25.7	6	32	ZQMX6N11-1E			
ZQ1616L03	16	16	100	16.4	3	16	ZQMX3N11-1E	M5 × 17	S4	
ZQ1616L04	16	16	100	16.4	4	16	ZQMX4N11-1E			
ZQ2020L03	20	20	125	20.4	3	20	ZQMX3N11-1E	M6 × 20	S5	
ZQ2020L04	20	20	125	20.4	4	20	ZQMX4N11-1E			
ZQ2525L03	25	25	150	25.4	3	20	ZQMX3N11-1E			
ZQ2525L04	25	25	150	25.4	4	20	ZQMX4N11-1E			
ZQ2525L05	25	25	150	25.4	5	25	ZQMX5N11-1E			
ZQ2525L06	25	25	150	25.7	6	32	ZQMX6N11-1E			
ZQ3225L03	32	25	170	25.4	3	25	ZQMX3N11-1E	M6 × 22	S5	
ZQ3225L04	32	25	170	25.4	4	25	ZQMX4N11-1E			
ZQ3225L05	32	25	170	25.4	5	25	ZQMX5N11-1E			
ZQ3225L06	32	25	170	25.7	6	32	ZQMX6N11-1E			

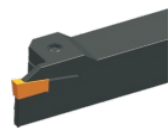

External Parting Blade

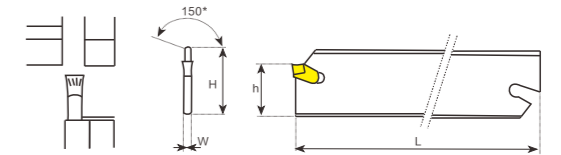

Type	Dimension				Adaptable Inserts	
	H	W	L	h		
	SPB326-S	26	2.4	110	21	ZQMX3N11-1E
	SPB426-S	26	3.2	110	21	ZQMX4N11-1E
	SPB526-S	26	4.0	110	21	ZQMX5N11-1E
	SPB626-S	26	5.2	110	21	ZQMX6N11-1E
	SPB332-S	32	2.4	150	25	ZQMX3N11-1E
	SPB432-S	32	3.2	150	25	ZQMX4N11-1E
	SPB532-S	32	4.0	150	25	ZQMX5N11-1E
	SPB632-S	32	5.2	150	25	ZQMX6N11-1E

External Threading Turning Tool

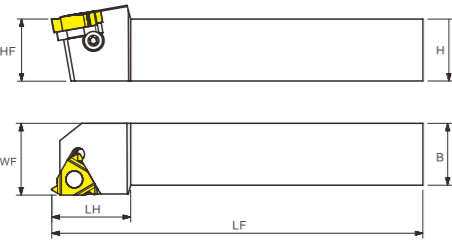

Type	Dimension					Adaptable Inserts	Inserts Screw	Shim	Shim Screw	Wrench	
	H	HF	B	LF	WF						
	SWR/L1010H11	10	10	10	100	16	R/LT11□□G-□□	L60 M2.5 × 6	—	—	T08
	SWR/L1212H11	12	12	12	100	16					
	SWR/L1616H16	16	16	16	100	20	R/LT16□□G-□□	L60 M3.5 × 12	TT16-□□	SS04008	T15 S2.5
	SWR/L2020K16	20	20	20	125	25					
	SWR/L2525M16	25	25	25	150	32					
	SWR/L3225P16	32	32	25	170	32					
	SWR/L3232P16	32	32	32	170	40					
	SWR/L2525M22	25	25	25	150	32					
	SWR/L2525P22	32	32	25	170	32					
	SWR/L3232P22	32	32	32	170	40					
	SWR/4040S22	40	40	40	250	50					
	SWR/L3232P22	32	32	32	170	40	R/LT27□□G-□□	L60 M6 × 16	TT27-□□		
	SWR/L4040S27	40	40	40	250	50					

External Threading Turning Tool



Type	Dimension							Adaptable Inserts	Screw	Shim	Shim Screw	Wrench
	DMIN	DCON	H	LF	WF	LRED						
	SNR/L0010K11	10	12	9.5	125	6	32	R/LT11□□L-□□	L60 M2.5 × 5			T08
	SNR/L0012K11	12	16	11.5	125	6	32					
	SNR/L0013M16	13	16	15.5	150	10	32	R/LT16□□L-□□	L60 M3.5 × 8	TT16	SS04008	T15 S2.5
	SNR/L0016M16	16	20	15.5	150	12	40					
	SNR/L0020Q16	20	25	19.5	180	14	40					
	SNR/L0025R16	25	30	24	200	16	45					
	SNR/L32S16	32	38	30	250	20	55					
	SNR/L0025R22	25	30	24	200	18	45					
	SNR/L0032S22	32	38	30	250	22	55					
	SNR/L0040T22	40	46	38	300	26	60					
	SNR/L0032S27	32	40	30	250	24	55	R/LT27□□L-□□	L60 M6 × 16	TT27		
	SNR/L0040T27	40	50	38	300	30	60					

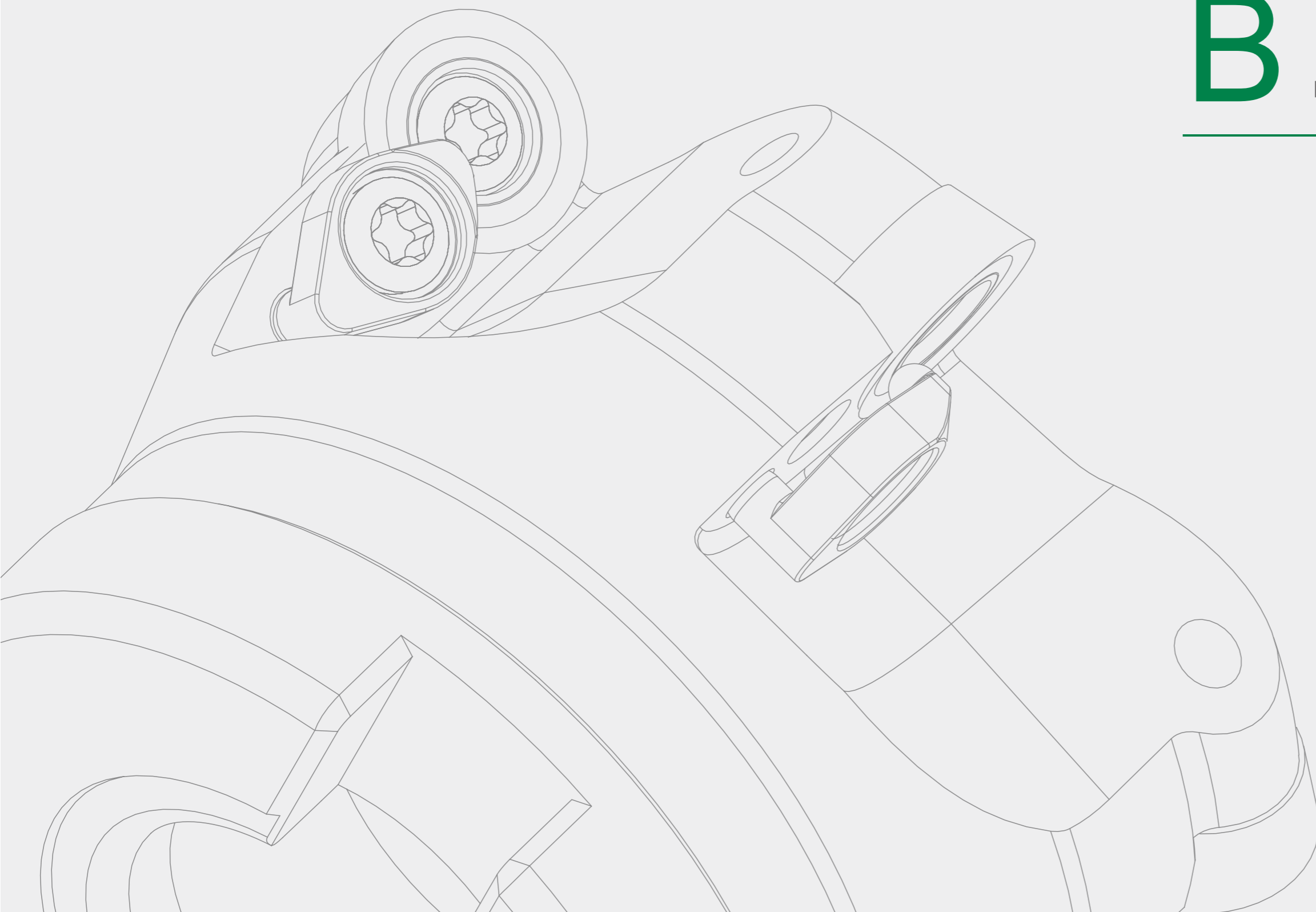

B

Milling Tools



Milling Insert Naming Rule

Shape

T P K N 22 04 ED T32 R OPM

A 	B 	C
D 	E 	H
K 	L 	M
O 	P 	R
S 	T 	T
V 	W 	Z

Chip Breaker and Hole

T P K N 22 04 ED T32 R OPM

Symbol	Center Hole	Chip Breaker	Insert Profile	Symbol	Center Hole	Chip Breaker	Insert Profile
B	Y	N		N	N	N	
H	Y	S		R	N	S	
C	Y	N		F	N	D	
J	Y	D		A	Y	N	
W	Y	N		M	Y	S	
T	Y	S		G	Y	D	
Q	Y	N		X			
U	Y	D					

Clearance Angle

T P K N 22 04 ED T32 R OPM

A 	B
C 	D
E 	F
G 	N
P 	O Others

Tolerance

T P K N 22 04 ED T32 R OPM

Symbol	m(mm)	d=l.C.(mm)	s(mm)	(reference)M grade tolerance detail(according to shape, size.) Tolerance of insert nose height						
				Inscribed Circle	Regular Triangle	Square	80° Rhombus	55° Rhombus	35° Rhombus	Round
				6.35	±0.08	±0.08	±0.08	±0.11	±0.16	...
				9.525	±0.08	±0.08	±0.08	±0.11	±0.16	...
				12.7	±0.13	±0.13	±0.13	±0.15
A	±0.005	±0.025	±0.025	15.875	±0.15	±0.15	±0.15	±0.18
F	±0.005	±0.013	±0.025	19.05	±0.15	±0.15	±0.15	±0.18
C	±0.013	±0.025	±0.025	25.4	...	±0.18
H	±0.013	±0.013	±0.013	●Tolerance of Inscribed Circle						
E	±0.025	±0.025	±0.025							
G	±0.025	±0.025	±0.13	Inscribed Circle	Regular Triangle	Square	80° Rhombus	55° Rhombus	35° Rhombus	Round
J	±0.005	±0.05-±0.13	±0.025	6.35	±0.05	±0.05	±0.05	±0.05	±0.05	
K	±0.013	±0.05-±0.13	±0.025	9.525	±0.05	±0.05	±0.05	±0.05	±0.05	±0.05
L	±0.025	±0.05-±0.13	±0.025	12.7	±0.08	±0.08	±0.08	±0.08	...	±0.08
M	±0.08-±0.18	±0.05-±0.13	±0.13	15.875	±0.1	±0.1	±0.1	±0.1	...	±0.1
N	±0.08-±0.18	±0.05-±0.13	±0.025	19.05	±0.1	±0.1	±0.1	±0.1	...	0.1
U	±0.13-±0.38	±0.08-±0.25	±0.1	25.4	...	±0.13	±0.13	±0.13

Milling Insert Naming Rule

Cutting Edge Length

T P K N 22 04 ED T32 R OPM

Inscribed Circle diameter(mm)	Insert Shape							
	C	D	R	S	T	V	W	K
3.97					06			
5			05					
5.56					09			
6			06					
6.35	06	07			11	11		
8			08					
9.525	09	11	09	09	16	16	06	16
10			10					
12			12					
12.7	12	15	12	12	22	22	08	
15.875	16		15	15	27			
16			19	16				
19.05	19		19	19	33			
20			20					
25	25	25	25					
25.4			25	25				
31.75			31					
32			32					

Thickness

T P K N 22 04 ED T32 R OPM

Symbol	Thickness(mm)
00	0.79
T0	0.99
01	1.59
T1	1.98
02	2.38
T2	2.58
03	3.18
T3	3.97
04	4.76
T4	4.96
05	5.56
T5	5.95
06	6.35
T6	6.75
07	7.94
09	9.52
T9	9.72
11	11.11
12	12.7

The Height Between Insert Bottom And Nose

Wiper Land and Clearance Angle

T P K N 22 04 ED T32 R OPM

Symbol	Clearance Angle	Symbol	Clearance Angle
A	45°	A	3°
D	60°	B	5°
E	75°	C	7°
F	85°	D	15°
P	90°	E	20°
Z	其它	F	25°
		G	30°
		N	0°
		P	11°
		Z	其它

Cutting Edge Preparation(mm)

T P K N 22 04 ED T32 R OPM

Symbol	Preparation 1	Preparation 2	Preparation 3	Preparation 4	Preparation 5	Preparation 6	Preparation 7	Symbol	
F								K	
E	0	5°	0	0.1	1	10°	1	0.15	P
T	2	15°	2	0.2	3	20°	3	0.25	W
S	4	25°	4	0.3	5	30°	5	0.35	
	6		6	0.4	7		7	0.45	

Cutting Direction

T P K N 22 04 ED T32 R OPM

Symbol	Direction
R	Right
L	Left
N	Neutral

Chip Breaker Code

T P K N 22 04 ED T32 R OPM

Code	Code
OPF	OPM
OPR	

Milling Tools Naming Rule



Type of Tools

FM 45 2 A22 63 5 SN13 L

FM	LM	SM	HM	RM	CM
Face milling Quare-shoulder milling	Indexable Helical Milling Tool	Slot milling	High feed	Profiling tool	Chamfer milling

Lead Angle

FM 45 2 A22 63 5 SN13 L

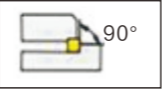
45°	75°	90°
		

Differentiate Code

FM 45 2 A22 63 5 SN13 L

Cutting Tool Diameter

FM 45 2 A22 63 5 SN13 L

Milling Tools Naming Rule

Adaptor Type

FM 45 2 A22 63 5 SN13 L

A	B	C	D	P	W	MT
A interface	B interface	C interface	D interface	Cylindrical shank	Lateral solid	Morse taper shank

Teeth Number

FM 45 2 A22 63 5 SN13 L

Type

FM 45 2 A22 63 5 SN13 L

Cutting Direction : Right/Left

FM 45 2 A22 63 5 SN13 L

Shell Structure

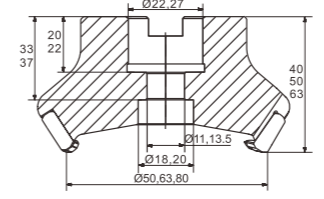
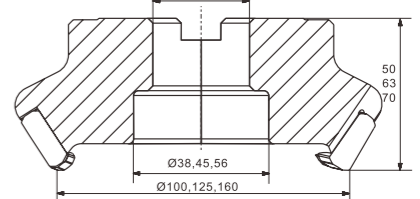
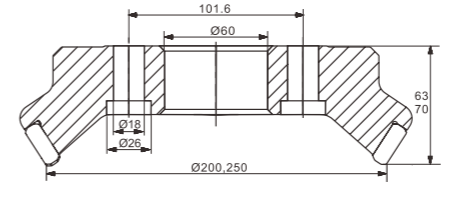
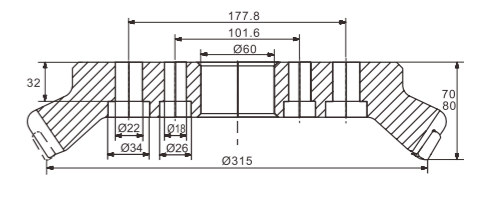

Type of Adapter		Type of Adapter	
	GB5342-96 of $\phi 50-\phi 80$ shell Facmilling Cutter		GB5342-96 of $\phi 100-\phi 160$ shell Facmilling Cutter
Type of Adapter		Type of Adapter	
	GB5342-96 of $\phi 50-\phi 80$ shell Facmilling Cutter		GB5342-96 of $\phi 315$ Facmilling Cutter

Grade introduction







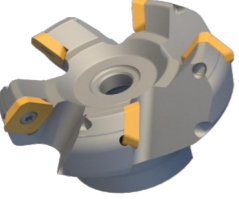

Coating	Brand	P	M	K	N	S	H
CVD	OC3220			»			
	OP2202	=		=			
PVD	OP1315	»	»	»			
	OP1325	»	»	»			
	OP1030	»		»			
	OP1630	»					
	OP1340	#	#				
Uncoated	OK434				»		

= stable cutting condition » normal cutting condition # bad cutting condition



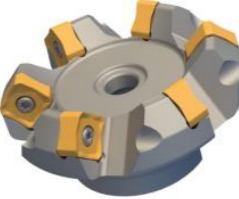





Chipbreaker introduction

chipbreaker	structure schematic	application scenarios
OM		strength cutting edge design, good anti-impact resistance, highly optimized for general use.
OL		sharp cutting edge design, provide smooth cutting, suitable for steady cutting condition.







Indexable milling insert list

Type	Tool Shape	Approach angle La MAX	Diameter	Adaptable Inserts	Insert Shape
Face Milling	FM451 	KAPR=45 APMX=5.9	Ø50-Ø200	SEKT12T3* SEET12T3*	
	FM454 	KAPR=45 APMX=4.3	Ø50-Ø200	ODMT0605*	
	FM452 	KAPR=45 APMX=6.5	Ø50-Ø250	SNMX1306A*	
	FM752 	KAPR=75 APMX=10.0	Ø50-Ø200	SNMX1306E*	

Indexable milling insert list

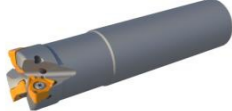
Type	Tool Shape	Approach angle La MAX	Diameter	Adaptable Inserts	Insert Shape
Face Milling	FM882 	KAPR=88 APMX=11.0	50- 200	SNMX1306Z*	
	FM453 	KAPR=45 APMX=5.5	50- 200	ONMU0504* ONMU0705* ONMU0906*	
Square Shoulder Milling	FM901 	KAPR=90 APMX=15.0	16- 80	APMT1135* APMT1604*	
	FM901F 	KAPR=90 APMX=10.0	16- 26	BXKT11T3*	

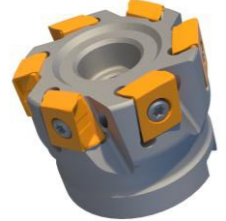
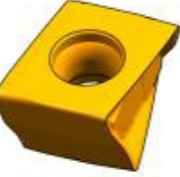
Indexable milling insert list

Type	Tool Shape	Approach angle La MAX	Diameter	Adaptable Inserts	Insert Shape
Square Shoulder Milling	FM902 	KAPR=90 ° APMX=13.0	Ø50-Ø200	TNGX1306*	
	FM903  	KAPR=90 ° APMX=8.0	Ø20-Ø200	WNMX0403* WNMX0806*	
	FM904 	KAPR=90 ° APMX=12.4	Ø20-Ø80	LNGX1306*	
	FM905 	KAPR=90 ° APMX=10.7	Ø40-Ø200	SDKT13T3*	

Indexable milling insert list

Type	Tool Shape	Approach angle La MAX	Diameter	Adaptable Inserts	Insert Shape
Profiling tool	RM01 		Ø25-Ø125	RPMW1003* RPKT1204*	
	RM02 		Ø16-Ø63	RDKW10T3* RDKW1204*	
High feed	HM192 	KAPR=19 ° APMX=1.9	Ø50-Ø125	PDMT1305*	

Face milling FM451 series

KAPR=45°

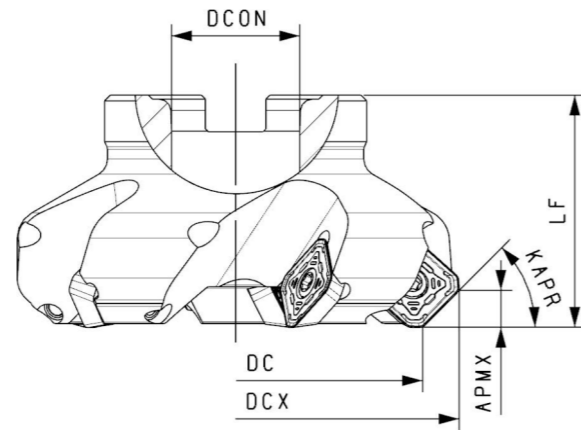
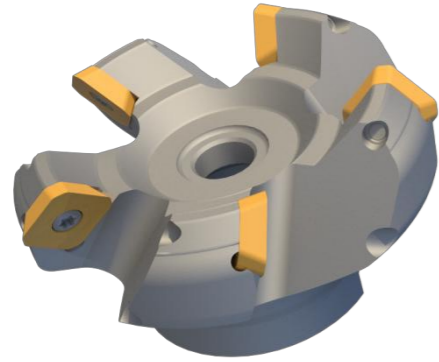

Type	stock	Number of flutes	Dimension						Interface	Adaptable Inserts	Screw	Wrench
			DC	DCX	DCON	LF	LH	APMX				
FM451-A22-50-3-SE12	●	3	50	63.7	22	40		5.9	A	SE*12T3 *	SA03512	T15P
FM451-A22-50-4-SE12	●	4	50	63.7	22	40		5.9	A			
FM451-A22-63-4-SE12	●	4	63	76.7	22	40		5.9	A			
FM451-A22-63-5-SE12	●	5	63	76.7	22	40		5.9	A			
FM451-A27-80-4-SE12	●	4	80	93.7	27	50		5.9	A			
FM451-A27-80-6-SE12	●	6	80	93.7	27	50		5.9	A			
FM451-B32-100-5-SE12	●	5	100	113.7	32	50		5.9	B			
FM451-B32-100-7-SE12	●	7	100	113.7	32	50		5.9	B			
FM451-B40-125-6-SE12	●	6	125	138.7	40	63		5.9	B			
FM451-B40-125-8-SE12	●	8	125	138.7	40	63		5.9	B			
FM451-C40-160-10-SE12	○	10	160	173.7	40	63		5.9	C			
FM451-C60-200-12-SE12	○	12	200	213.7	60	63		5.9	C			

● Stock available ○ Make-to-order

FM451 milling insert

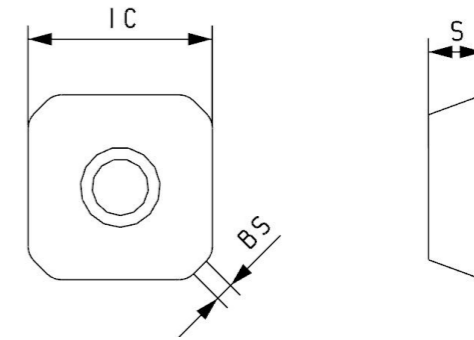
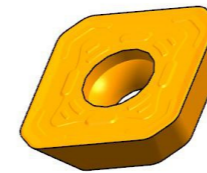

= stable cutting condition >> normal cutting condition # bad cutting condition

Material	Dimension								C V D	P V D						Uncoated OK434
	IC	L	W1	S	D1	RE	BS	OC3220		OP2202	OP1315	OP1325	OP1030	OP1630	OP1340	
P									=	>>	>>	>>	>>	#		
M										>>	>>			#		
K									>>	=	>>	>>				
N															>>	
S																
H																
SEET12T3-QPF	13.4			3.97			1.3				○					
SEET12T3-QPM	13.4			3.97			1.3		○	○		○				
SEET12T3-QPR	13.4			3.97			1.3		○	○						
SEKT12T3-OM	13.4			3.97			1.3		○		●					

● Stock available ○ Make-to-order

Face milling FM454 series

KAPR=45°

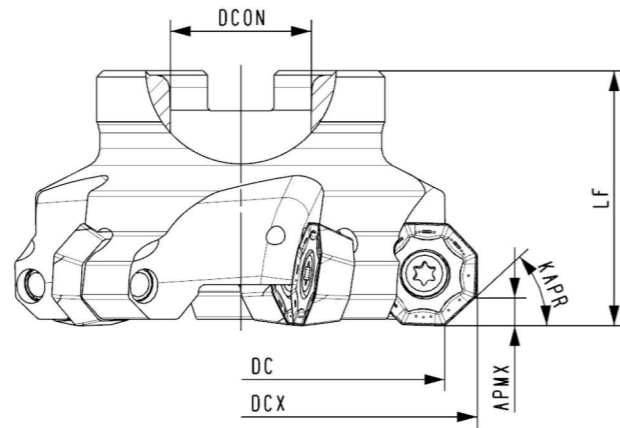
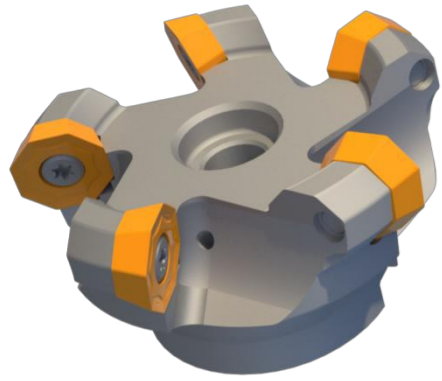

Type	stock	Number of flutes	Dimension						Interface	Adaptable Inserts	Screw	Wrench
			DC	DCX	DCON	LF	LH	APMX				
FM454-A22-50-4-OD06-C	●	4	50	60.4	22	40		4.3	A	OD*0605ADR*	SA0512	T20P
FM454-A22-63-5-OD06-C	●	5	63	73.4	22	40		4.3	A			
FM454-A27-80-6-OD06-C	●	6	80	90.4	27	50		4.3	A			
FM454-B32-100-7-OD06	●	7	100	110.4	32	50		4.3	B			
FM454-B40-125-8-OD06	●	8	125	135.4	40	63		4.3	B			
FM454-C40-160-10-OD06	○	10	160	170.4	40	63		4.3	C			
FM454-C60-200-12-OD06	○	12	200	210.4	60	63		4.3	C			

● Stock available ○ Make-to-order

FM454 milling insert

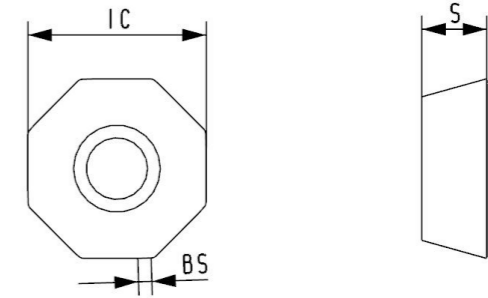
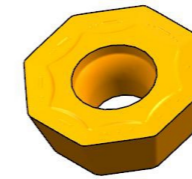

= stable cutting condition >> normal cutting condition # bad cutting condition

Material	Dimension								C V D	P V D						Un pe re su n
	IC	L	W1	S	D1	RE	BS	OC3220		OP2202	OP1315	OP1325	OP1030	OP1630	OP1340	
P									=	>>	>>	>>	>>			#
M											>>	>>				#
K									>>	=	>>	>>	>>			
N																>>
S																
H																
Type																
ODMT0605ADR-OM	16.2			5.9				1.2		O		●				

● Stock available ○ Make-to-order

Face milling FM452 series

FM452 milling insert

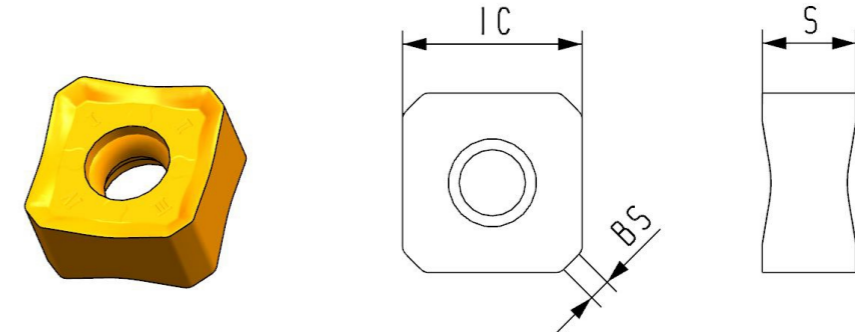
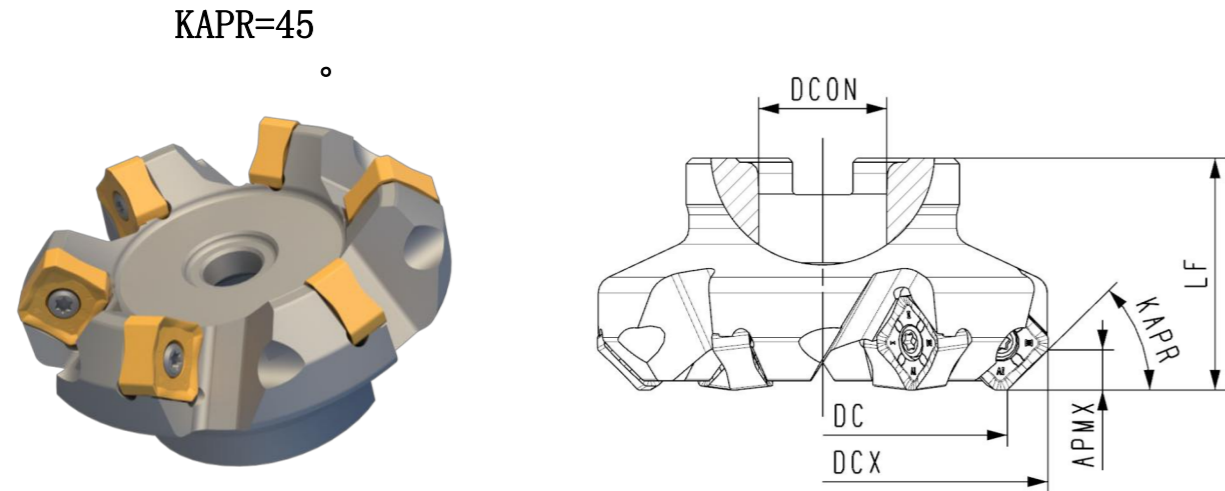

Type	stock	Number of flutes	Dimension						Interface	Adaptable Inserts	Screw	Wrench
			DC	DCX	DCON	LF	LH	APMX				
FM452-A22-50-5-SN13	●	5	50	64.6	22	40		6.5	A	SN*1306ANN*	SA0411	T15P
FM452-A22-63-4-SN13	●	4	63	77.6	22	40		6.5	A			
FM452-A22-63-6-SN13	●	6	63	77.6	22	40		6.5	A			
FM452-A27-80-5-SN13	●	5	80	94.6	27	50		6.5	A			
FM452-A27-80-7-SN13	●	7	80	94.6	27	50		6.5	A			
FM452-B32-100-6-SN13	●	6	100	114.6	32	50		6.5	B			
FM452-B32-100-8-SN13	●	8	100	114.6	32	50		6.5	B			
FM452-B40-125-8-SN13	●	8	125	139.6	40	63		6.5	B			
FM452-B40-125-10-SN13	●	10	125	139.6	40	63		6.5	B			
FM452-C40-160-12-SN13	●	12	160	174.6	40	63		6.5	C			
FM452-C60-200-16-SN13	●	16	200	214.6	60	63		6.5	C			
FM452-C60-250-20-SN13		20	250	264.6	60	63		6.5	C			
FM452-D60-315-24-SN13	○	24	315	329.6	60	70		6.5	D			

● Stock available ○ Make-to-order

= stable cutting condition >> normal cutting condition # bad cutting condition

Material	Dimension								OC3220	OP2202	OP1315	OP1325	OP1030	OP1630	OP1340	OK434
	P	M	K	N	S	H	C	V								
P	=	>>	>>	>>	>>	>>										#
M		>>	>>													#
K	>>	=	>>	>>	>>											
N																>>
S																
H																
SNMX1306ANN-OL	13				6.8			1.6				●				○
SNMX1306ANN-OM	13				6.8			1.6		●		●				
SNGX1306ANN-LM	13				6.8			1.6		○		○				

● Stock available ○ Make-to-order

Face milling FM752 series

KAPR=75°

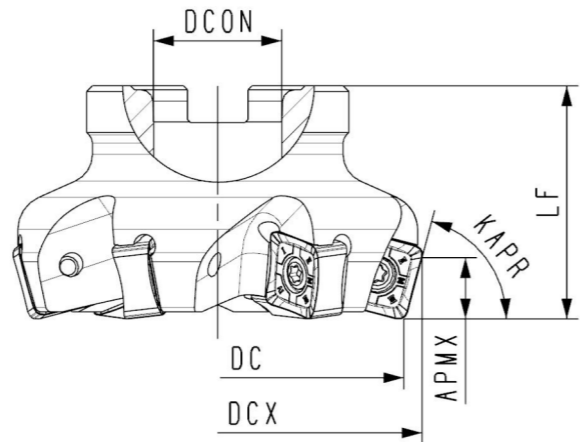

Type	stock	Number of flutes	Dimension						Interface	Adaptable Inserts	Screw	Wrench
			DC	DCX	DCON	LF	LH	APMX				
FM752-A22-50-5-SN13	●	5	50	57.2	22	40		10	A	SN*1306ENN*	SA0411	T15P
FM752-A22-63-6-SN13	●	6	63	87.2	22	40		10	A			
FM752-A27-80-7-SN13	●	7	80	87.2	27	50		10	A			
FM752-B32-100-8-SN13	●	8	100	114.6	32	50		10	B			
FM752-B40-125-10-SN13	●	10	125	139.6	40	63		10	B			
FM752-C40-160-12-SN13	○	12	160	174.6	40	63		10	C			
FM752-C60-200-16-SN13	○	16	200	214.6	60	63		10	C			

● Stock available ○ Make-to-order

FM752 milling insert

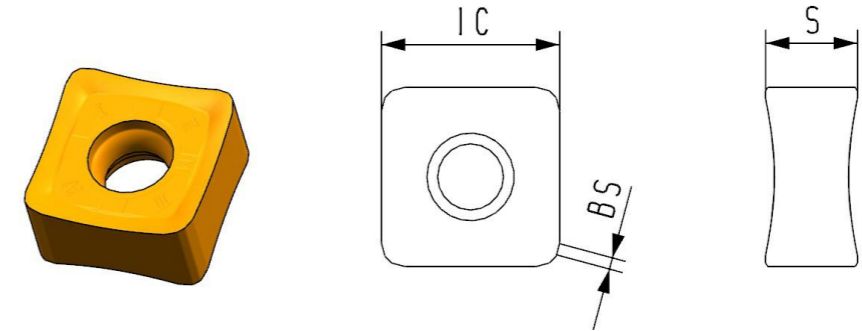

= stable cutting condition >> normal cutting condition # bad cutting condition

Material	Dimension								C V D	P V D				Uncoated pelecoru		
	IC	L	W1	S	D1	RE	BS	OC3220		OP2202	OP1315	OP1325	OP1030		OP1630	OP1340
P										=	>>	>>	>>	>>	#	
M											>>	>>			#	
K									>>	=	>>	>>	>>			
N																>>
S																
H																
SNMX1306ENN-OM	13			7			1		○		●					

● Stock available ○ Make-to-order

Face milling FM882 series

KAPR=88

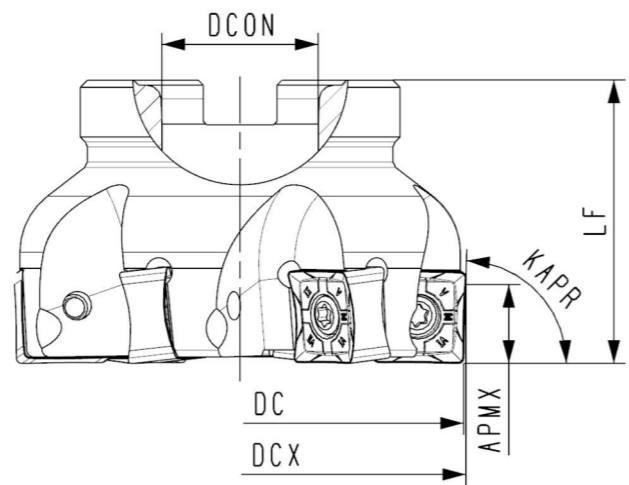
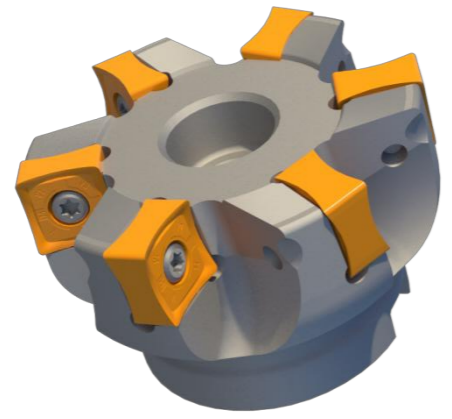

FM882 milling insert

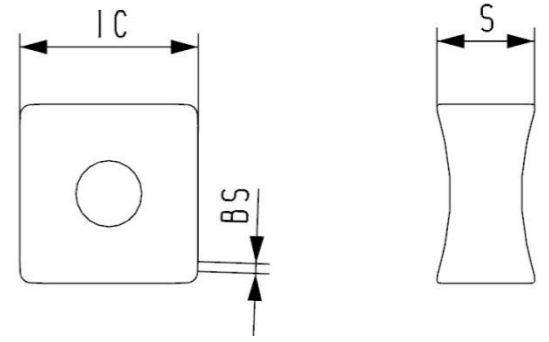
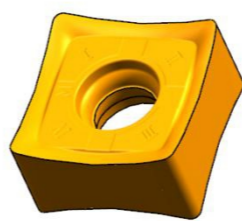

Type	stock	Number of flutes	Dimension						Interface	Adaptable Inserts	Screw	Wrench
			DC	DCX	DCON	LF	LH	APMX				
FM882-A22-50-5-SN13	●	5	50	50.6	22	40		11	SN*1306ZNN*	SA0411	T15P	
FM882-A22-63-6-SN13	●	6	63	63.6	22	40		11				
FM882-A27-80-7-SN13	●	7	80	80.6	27	50		11				
FM882-B32-100-8-SN13	●	8	100	100.6	32	50		11				
FM882-B40-125-10-SN13	●	10	125	125.6	40	63		11				
FM882-C40-160-12-SN13	○	12	160	160.6	40	63		11				
FM882-C60-200-16-SN13	○	16	200	200.6	60	63		11				

● Stock available ○ Make-to-order

= stable cutting condition >> normal cutting condition # bad cutting condition

Material	Dimension								C V D	P V D					Uncoated	
	IC	L	W1	S	D1	RE	BS	OC3220		OP2202	OP1315	OP1325	OP1030	OP1630		OP1340
P										=	>>	>>	>>	>>	#	
M											>>	>>			#	
K									>>	=	>>	>>	>>			
N																>>
S																
H																
SNMX1306ZNN-D	13			7		0.8	1					●				
SNMX1306ZNN-Ø	13			7		0.8	1		●		●					

● Stock available ○ Make-to-order

Face milling FM453 series

KAPR=45

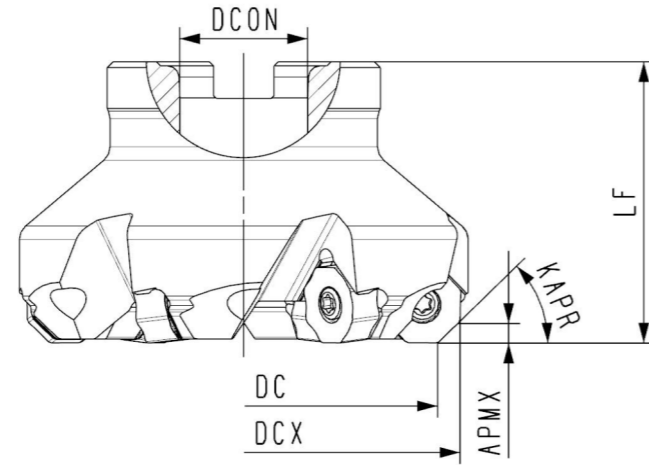
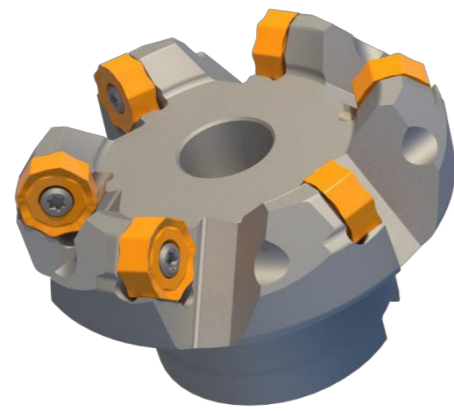

FM453 milling insert

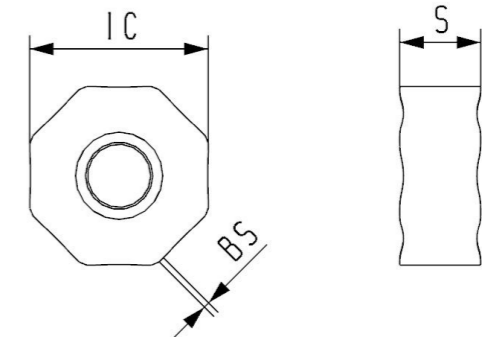
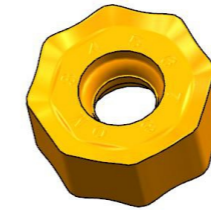

Type	stock	Number of flutes	Dimension						Interface	Adaptable Inserts	Screw	Wrench
			DC	DCX	DCON	LF	LH	APMX				
FM453-A22-50-5-ON05	●	5	53	64.6	22	48.4		3.2	A	ON*0504*	SA0411	T15P
FM453-A22-63-6-ON05	●	6	66	77.6	22	48.4		3.2	A			
FM453-A27-80-7-ON05	●	7	83	94.6	27	48.4		3.2	A			
FM453-B32-100-8-ON05	●	8	103	114.6	32	48.4		3.2	B			
FM453-B40-125-10-ON05	●	10	128	139.6	40	61.4		3.2	B			
FM453-C40-160-12-ON05	○	12	163	174.6	40	61.4		3.2	C			
FM453-C60-200-16-ON05	○	16	203	214.6	60	61.4		3.2	C			
FM453-A22-63-6-ON07	●	6	63	74.4	22	50		4.3	A	ON*0705*	SA0512	T20P
FM453-A27-80-7-ON07	●	7	80	91.4	27	50		4.3	A			
FM453-B32-100-8-ON07	●	8	100	111.4	32	50		4.3	B			
FM453-B40-125-10-ON07	●	10	125	136.4	40	63		4.3	B			
FM453-C40-160-12-ON07	○	12	160	171.4	40	63		4.3	C			
FM453-C60-200-16-ON07	○	16	200	211.4	60	63		4.3	C			
FM453-A22-63-5-ON09	●	5	63	76.2	22	50		5.5	A	ON*0906*	SA0512	T20P
FM453-A27-80-6-ON09	●	6	80	93.2	27	50		5.5	A			
FM453-B32-100-7-ON09	●	7	100	113.2	32	50		5.5	B			
FM453-B40-125-8-ON09	●	8	125	138.2	40	63		5.5	B			
FM453-C40-160-10-ON09	○	10	160	173.2	40	63		5.5	C			
FM453-C60-200-12-ON09	○	12	200	213.2	60	63		5.5	C			

● Stock available ○ Make-to-order

= stable cutting condition >> normal cutting condition # bad cutting condition

Material	Dimension								OC3220	OP2202	OP1315	OP1325	OP1030	OP1630	OP1340	OK434
	P	M	K	N	S	H	C	V								
Material	P															#
	M															#
	K	>>	=	>>	>>	>>										
	N															>>
	S															
Type	IC	L	W1	S	DI	RE	BS									
	ONMU0504ANN-OL	13			5.9		0.8				●				○	
	ONMU0504ANN-OM	13			5.9		0.4		●		●					
	ONGU0504ANR-W	13			5.9		4.2				○					
ONMU070508-OM	17.5			6.3					○		●					
ONMU0906ANN-OL	20.5			7.2			1.2				●					
ONMU0906ANN-OM	20.5			7.2			1.2		○		●					

● Stock available ○ Make-to-order

Square shoulder milling insert FM901 series

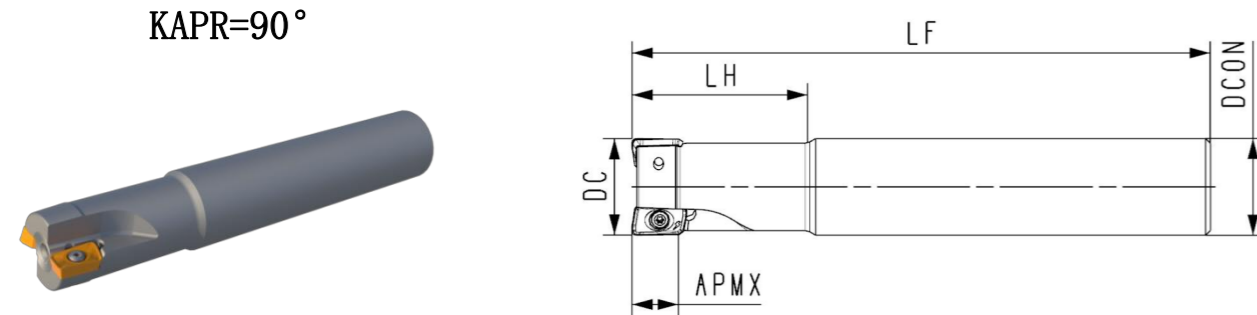

Type	stock	Number of flutes	Dimension					Interface	Adaptable Inserts	Screw	Wrench				
			DC	DCX	DCON	LF	LH					APMX			
FM901-P16-16-2-AP11-120	●	2	16		16	120	35	10	P	AP*1135*	SA025065	T08P			
FM901-P16-16-2-AP11-170	○	2	16		16	170	40	10	P						
FM901-P16-17-2-AP11-150	●	2	17		16	150	40	10	P						
FM901-P16-17-2-AP11-200	○	2	17		16	200	50	10	P						
FM901-P20-20-2-AP11-120	●	2	20		20	120	35	10	P						
FM901-P20-20-2-AP11-170	○	2	20		20	170	40	10	P						
FM901-P20-21-2-AP11-150	●	2	21		20	150	40	10	P						
FM901-P20-21-2-AP11-200	○	2	21		20	200	50	10	P						
FM901-P25-25-3-AP11-120	●	3	25		25	120	35	10	P						
FM901-P25-25-3-AP11-170	○	3	25		25	170	40	10	P						
FM901-P25-25-2-AP16-120	●	2	25		25	120	35	15	P				AP*1604*	SA0411	T15P
FM901-P25-25-2-AP16-170	○	2	25		25	170	40	15	P						
FM901-P25-26-2-AP16-160	●	2	26		25	160	40	15	P						
FM901-P25-26-2-AP16-200	○	2	26		25	200	50	15	P						
FM901-P32-32-3-AP16-160	●	3	32		32	160	40	15	P						
FM901-P32-32-3-AP16-200	○	3	32		32	200	50	15	P						
FM901-P32-40-4-AP16-160	●	4	40		32	160	40	15	P						
FM901-P32-40-4-AP16-200	○	4	40		32	200	50	15	P						

● Stock available ○ Make-to-order

Square shoulder milling insert FM901 series

KAPR=90°

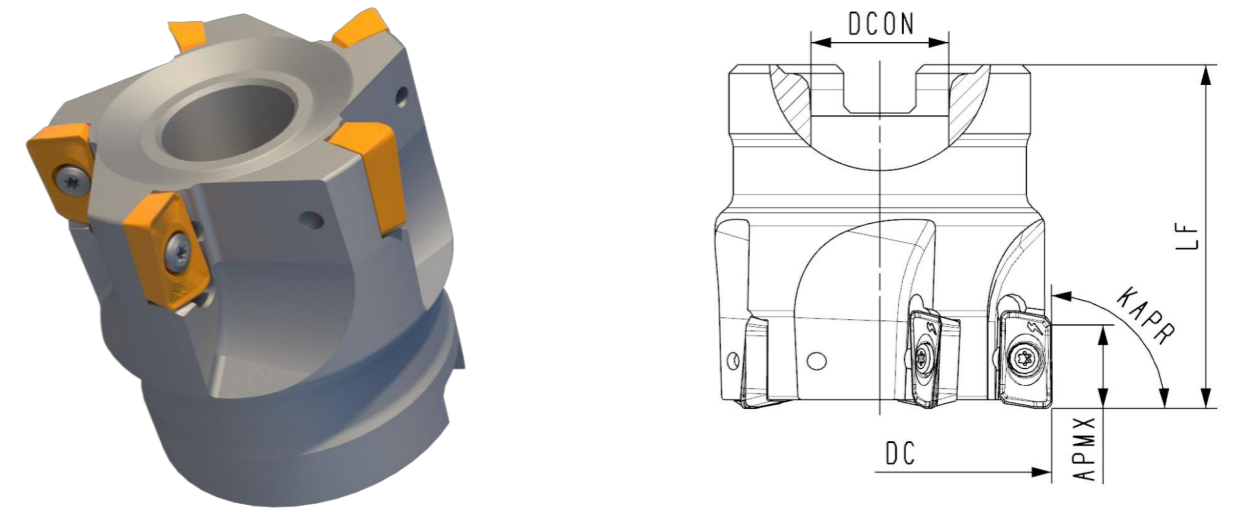

Type	stock	Number of flutes	Dimension					Interface	Adaptable Inserts	Screw	Wrench	
			DC	DCX	DCON	LF	LH					APMX
FM901-A16-40-5-AP11	○	5	40		16	50		10	A	AP*1135*	SA025065	T08P
FM901-A22-50-6-AP11	○	6	50		22	50		10	A			
FM901-A22-63-7-AP11	○	7	63		22	50		10	A			
FM901-A22-50-4-AP16	●	4	50		22	50		15	A	AP*1604*	SA0411	T15P
FM901-A22-63-5-AP16	●	5	63		22	50		15	A			
FM901-A27-80-6-AP16	○	6	80		27	50		15	A			

● Stock available ○ Make-to-order

FM901 milling insert

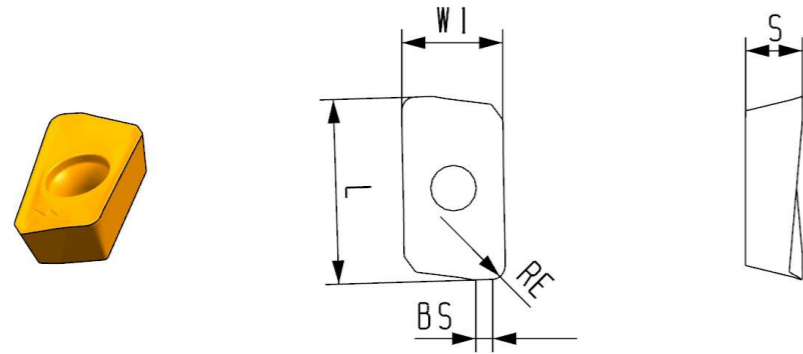

= stable cutting condition >> normal cutting condition # bad cutting condition

Material	Dimension								C V D	P V D				Uncoated paipocoun	
	IC	L	W1	S	D1	RE	BS	OC3220		OP2202	OP1315	OP1325	OP1030		OP1630
P								=	>>	>>	>>	>>	#		
M									>>	>>			#		
K								>>	=	>>	>>				
N															>>
S															
H															
APMT1135PDER-SDX		11.4	6.22	3.5		0.8	1								
APMT1604PDER-SDX		17.4	9.27	4.8		0.8	1.5								

● Stock available ○ Make-to-order

Square shoulder milling insert FM901 series

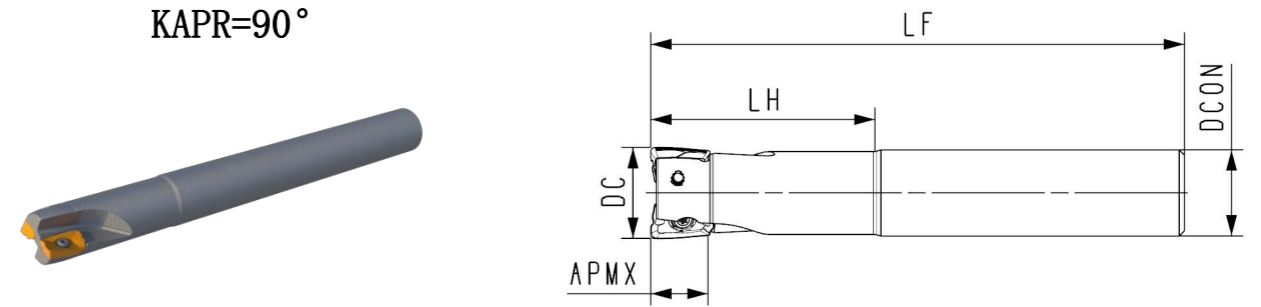

Type	stock	Number of flutes	Dimension						Interface	Adaptable Inserts	Screw	Wrench
			DC	DCX	DCON	LF	LH	APMX				
FM901F-P16-16-2-BX11-100	○	2	16		16	120	35	10	P	BX*11T3*	SA025065	T08P
FM901F-P16-17-2-BX11-150	●	2	17		16	150	40	10	P			
FM901F-P20-20-2-BX11-120	○	2	20		20	120	35	10	P			
FM901F-P20-21-2-BX11-200	●	2	21		20	170	40	10	P			
FM901F-P25-25-3-BX11-120	○	3	25		25	120	35	10	P			
FM901F-P25-26-3-BX11-200	●	3	26		25	170	40	10	P			

● Stock available ○ Make-to-order

FM901F indexable milling head

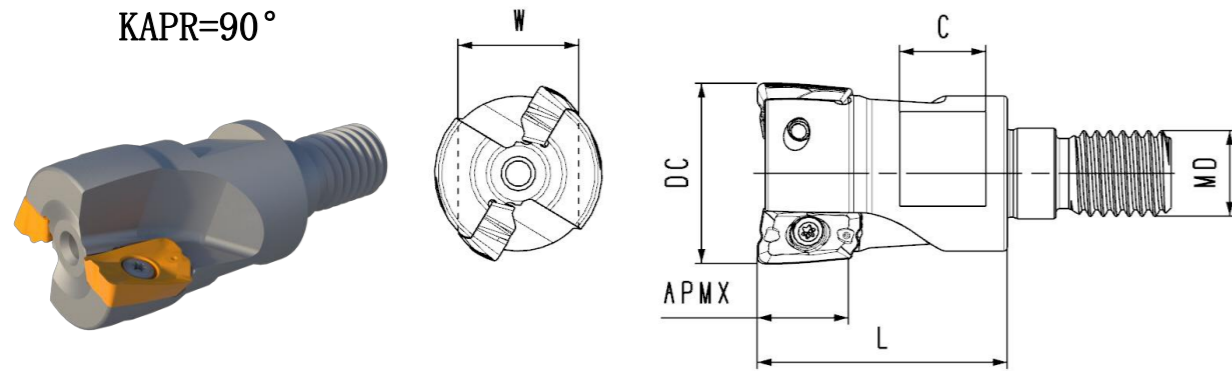

Type	stock	Number of flutes	Dimension						Interface	Adaptable Inserts	Screw	Wrench
			DC	DCX	MD	L	W	APMX				
FM901F-M8-17-2-BX11	●	2	17		M8	25	12	10		BX*11T3*	SA025065	T08P
FM901F-M10-21-2-BX11	●	2	21		M10	29	14	10				
FM901F-M12-26-3-BX11	●	3	26		M12	37	17	10				

● Stock available ○ Make-to-order

FM901F milling insert

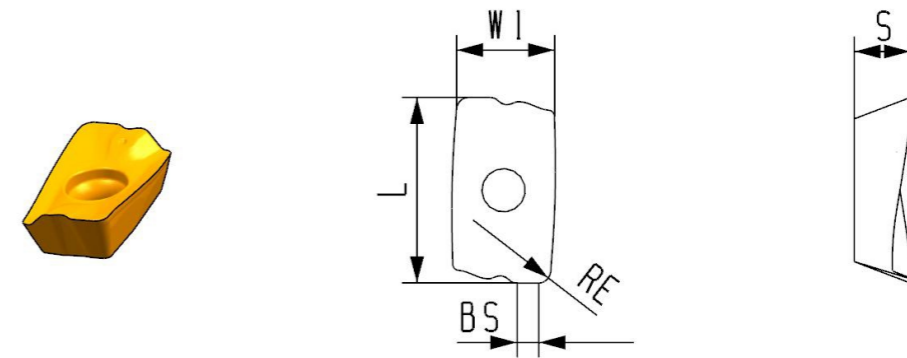

= stable cutting condition >> normal cutting condition # bad cutting condition

Material	Dimension								C V D	P V D						Uncoated pejapoc
	IC	L	W1	S	D1	RE	BS	OC3220		OP2202	OP1315	OP1325	OP1030	OP1630	OP1340	
P										=	>>	>>	>>	>>	#	
M											>>	>>			#	
K									>>	=	>>	>>	>>			
N																>>
S																
H																
BXKT11T304PER-OM		12.2	6.8	3.7		0.4	1.8			○		●				
BXKT11T308PER-OM		12.2	6.8	3.7		0.8	1.4			○		●				

● Stock available ○ Make-to-order

Square shoulder milling insert FM902 series

KAPR=90°

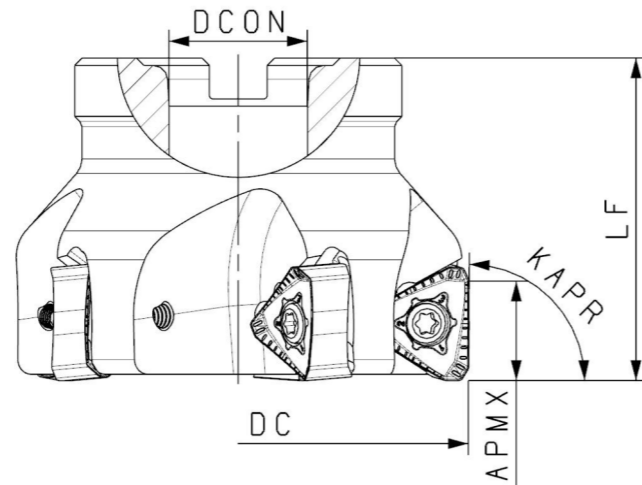
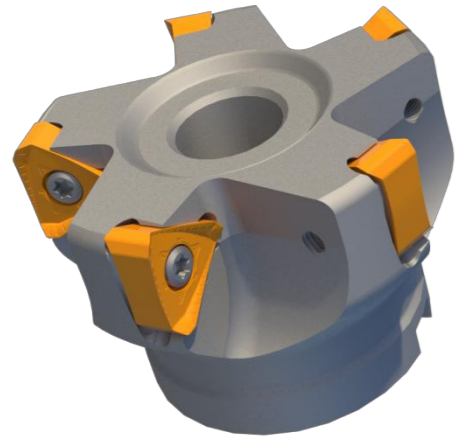

Type	stock	Number of flutes	Dimension						Interface	Adaptable Inserts	Screw	Wrench
			DC	DCX	DCON	LF	LH	APMX				
FM902-A22-50-4-TN13	●	4	50		22	40		13	A	TN*1306*	SA0411	T15P
FM902-A22-63-5-TN13	●	5	63		22	40		13	A			
FM902-A27-80-7-TN13	●	7	80		27	50		13	A			
FM902-B32-100-8-TN13	●	8	100		32	50		13	B			
FM902-B40-125-10-TN13	●	10	125		40	63		13	B			
FM902-C40-160-12-TN13	○	12	160		40	63		13	C			
FM902-C60-200-16-TN13	○	16	200		60	63		13	C			

● Stock available ○ Make-to-order

FM902 milling insert

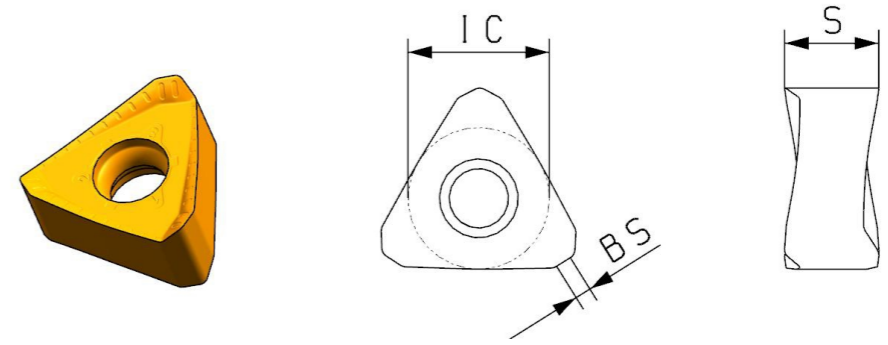

= stable cutting condition >> normal cutting condition # bad cutting condition

Material	P								C	V	D	P					Uncoated						
	M											OC3220	OP2202	OP1315	OP1325	OP1030		OP1630	OP1340	OK434			
Type	K								IC	L	W1						S				D1	RE	BS
	N											OC3220	OP2202	OP1315	OP1325	OP1030		OP1630	OP1340	OK434			
S								OC3220	OP2202	OP1315	OP1325						OP1030				OP1630	OP1340	OK434
H												OC3220	OP2202	OP1315	OP1325	OP1030		OP1630	OP1340	OK434			
TNGX1306PNFR-1	11.46			7.6				1.3		○	○						●						

● Stock available ○ Make-to-order

Square shoulder milling insert FM903 series

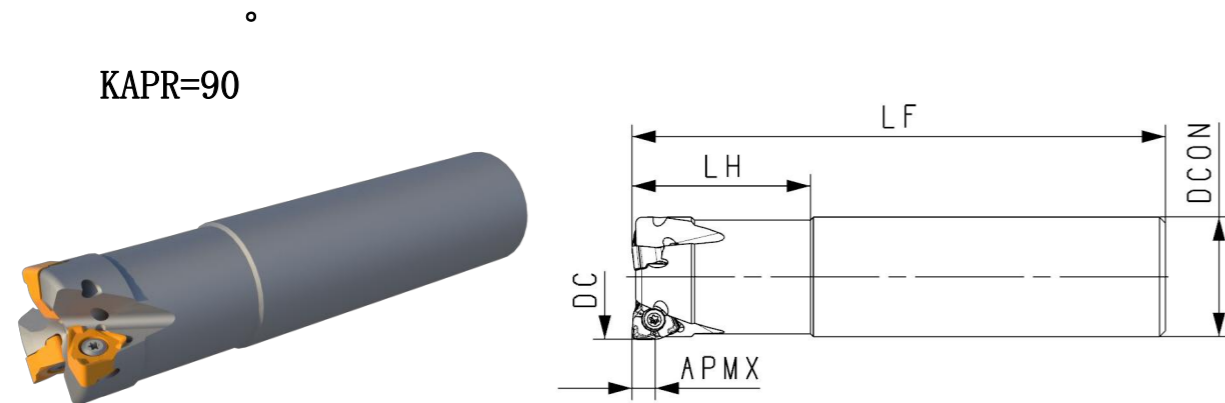

Type	stock	Number of flutes	Dimension						Interface	Adaptable Inserts	Screw	Wrench
			DC	DCX	DCON	LF	LH	APMX				
FM903-P20-20-2-WN04-120	○	2	20			120	35	3.8	P	WN*X0403*	SA025065	T08P
FM903-P20-20-3-WN04-120	●	3	20			120	35	3.8	P			
FM903-P20-21-3-WN04-120	○	3	21			120	35	3.8	P			
FM903-P25-25-4-WN04-120	●	4	25			120	35	3.8	P			
FM903-P25-26-4-WN04-120	○	4	26			120	35	3.8	P			
FM903-P32-32-4-WN04-150	●	4	32			150	35	3.8	P			
FM903-P32-33-4-WN04-150	○	4	33			150	35	3.8	P			
FM903-W32-32-2-WN08-120	○	2	32			120	35	8	W	WN*X0806*	SA0411	T15P
FM903-W32-40-4-WN08-120	○	4	40			120	35	8	W			

● Stock available ○ Make-to-order

Square shoulder milling insert FM903 series

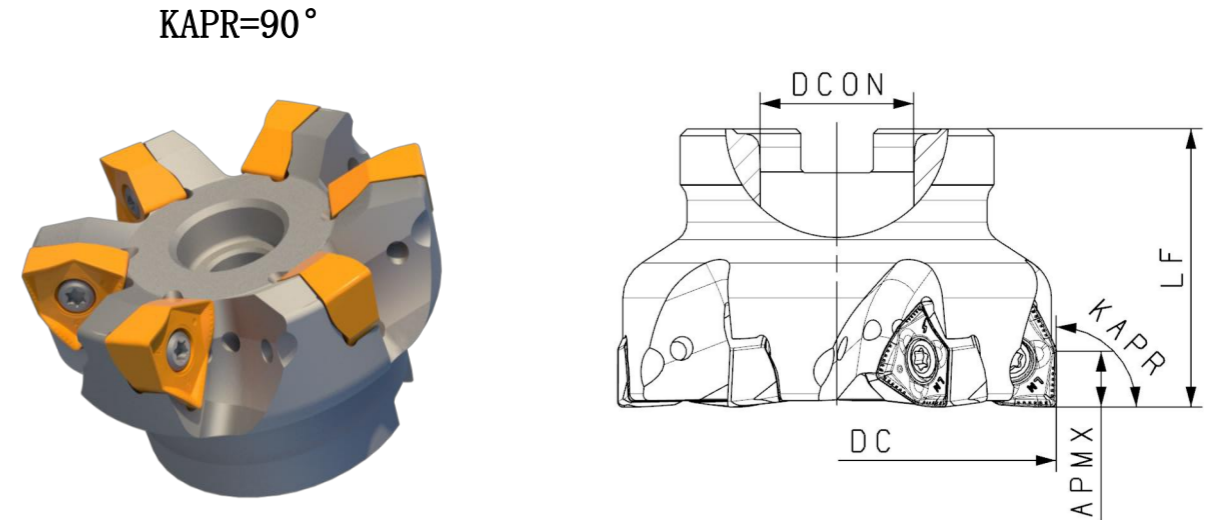

Type	stock	Number of flutes	Dimension						Interface	Adaptable Inserts	Screw	Wrench
			DC	DCX	DCON	LF	LH	APMX				
FM903-A16-40-5-WN04	●	5	40		22	40		3.8	A	WN*X0403*	SA025065	T08P
FM903-A22-50-6-WN04	●	6	50		22	40		3.8	A			
FM903-A22-50-5-WN08	●	5	50		22	40		8	A	WN*X0806*	SA0411	T15P
FM903-A22-63-6-WN08	●	6	63		22	40		8	A			
FM903-A27-80-7-WN08	●	7	80		27	50		8	A			
FM903-B32-100-8-WN08	●	8	100		32	50		8	B			
FM903-B40-125-10-WN08	●	10	125		40	63		8	B			
FM903-C40-160-12-WN08	○	12	160		40	63		8	C			
FM903-C60-200-16-WN08	○	16	200		60	63		8	C			

● Stock available ○ Make-to-order

FM903 milling insert

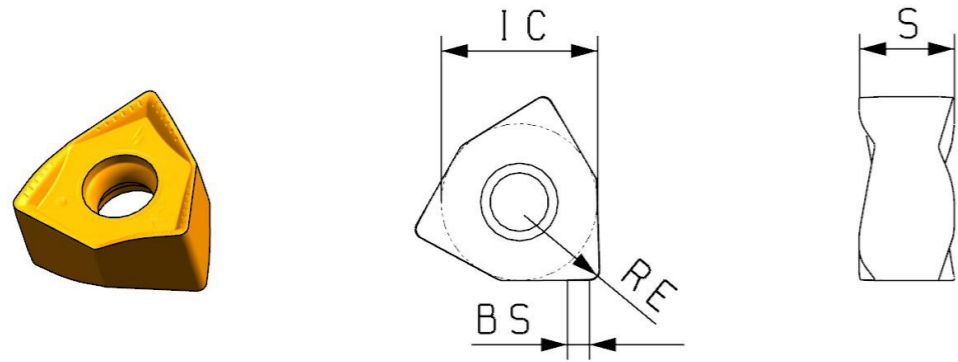

= stable cutting condition >> normal cutting condition # bad cutting condition

Material	Dimension								C V D	P V D								Uncoated
	IC	L	W1	S	D1	RE	BS	OC3220		OP2202	OP1315	OP1325	OP1030	OP1630	OP1340	OK434		
P									=	>>	>>	>>	>>		#			
M										>>	>>				#			
K									>>	=	>>	>>	>>					
N																>>		
S																		
H																		
WNGX040304R-LM	6.5			4		0.4	0.85											
WNMX040308R-OM	6.5			4		0.8	0.5											
WNGX080604R-LM	12.85			6.45		0.4	2.5											
WNMX080608R-OL	12.85			7.8		0.8	1.1											
WNMX080608R-OM	12.85			7.8		0.8	0.8											
WNGX080608R-LF	12.85			6.57		0.8	1.8											
WNGX080608R-LM	12.85			6.45		0.8	2											

● Stock available ○ Make-to-order

Square shoulder milling insert FM904 series

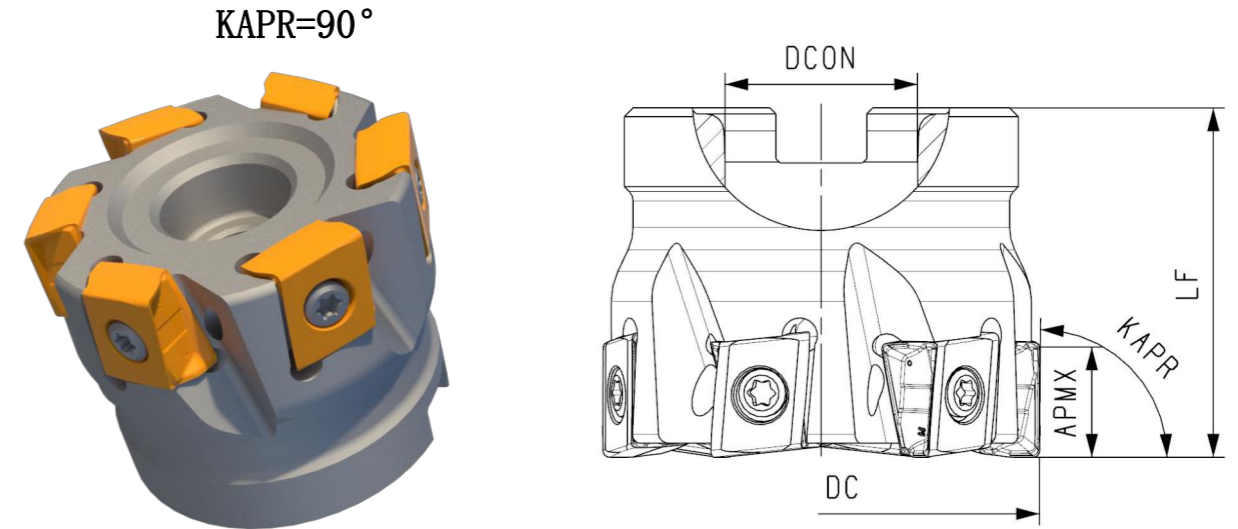

Type	stock	Number of flutes	Dimension					Interface	Adaptable Inserts	Screw	Wrench
			DC	DCX	DCON	LF	LH				
FM904-A22-50-5-LN13	●	5	50		22	40		8	A		
FM904-A22-50-6-LN13	○	6	50		22	40		8	A		
FM904-A22-63-6-LN13	●	6	63		22	40		8	A		
FM904-A22-63-8-LN13	○	8	63		22	40		8	A		
FM904-A27-80-7-LN13	●	8	80		27	50		8	A		
FM904-A27-80-10-LN13	○	10	80		27	50		8	A		

● Stock available ○ Make-to-order

FM904 milling insert

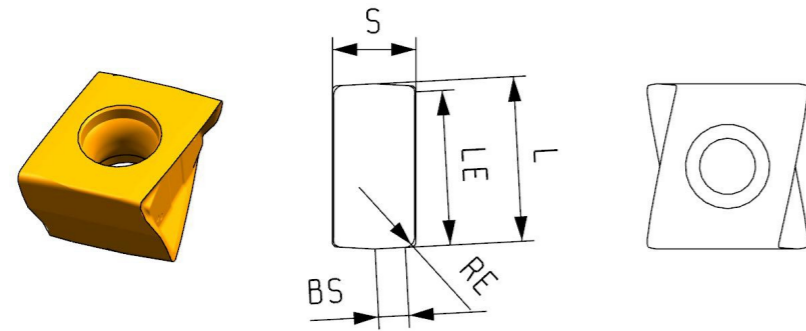

= stable cutting condition >> normal cutting condition # bad cutting condition

Material	Dimension								C V D	P V D						Универсальный OK434
	IC	L	LE	S	D1	RE	BS	OC3220		OP2202	OP1315	OP1325	OP1030	OP1630	OP1340	
P									=	>>	>>	>>	>>	#		
M										>>	>>			#		
K									>>	=	>>	>>				
N															>>	
S																
H																
LNGX130608PR-LM		13.2	12.4	6.7		0.8	2.4		○		●			○		

● Stock available ○ Make-to-order

Square shoulder milling insert FM905 series

KAPR=90°

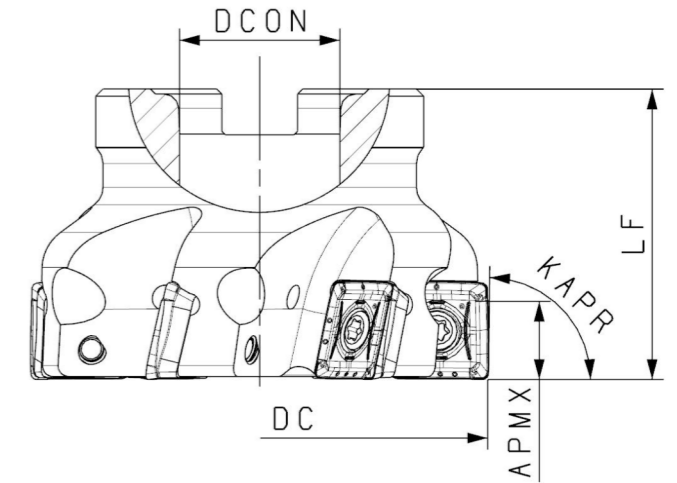
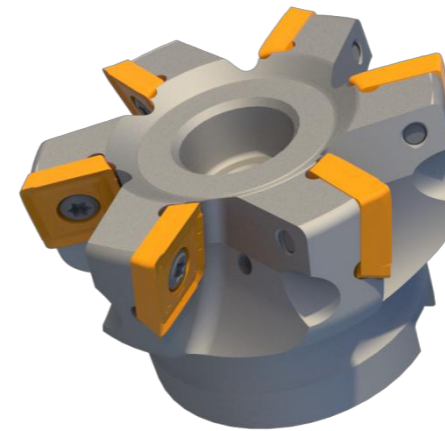

Type	stock	Number of flutes	Dimension					Interface	Adaptable Inserts	Screw	Wrench
			DC	DCX	DCON	LF	LH				
FM905-A22-50-4-SD13	○	4	50		22	40		10.7	A		
FM905-A22-50-5-SD13	●	5	50		22	40		10.7	A		
FM905-A22-63-6-SD13	●	6	63		22	40		10.7	A		
FM905-A27-80-7-SD13	●	7	80		27	50		10.7	A	SDKT13T3*	SA0411 T15P
FM905-B32-100-8-SD13	●	8	100		32	50		10.7	B		
FM905-B40-125-10-SD13	●	10	125		40	63		10.7	B		
FM905-C40-160-12-SD13	○	12	160		40	63		10.7	C		
FM905-C60-200-16-SD13	○	16	200		60	63		10.7	C		

● Stock available ○ Make-to-order

FM905 milling insert

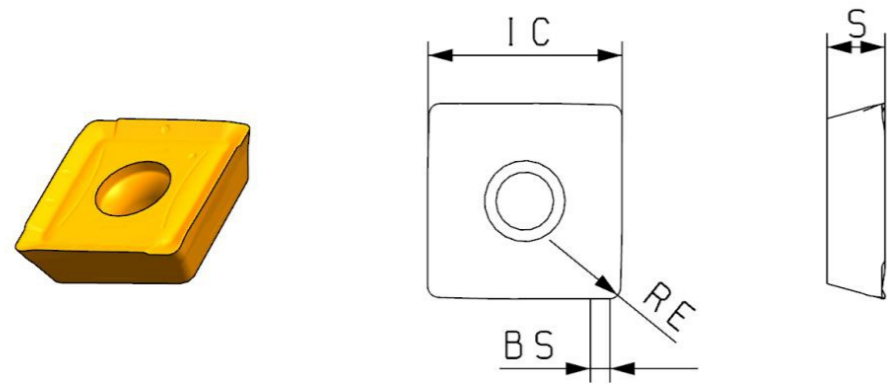

= stable cutting condition >> normal cutting condition # bad cutting condition

Material	Dimension								C V D	P V D						U p a e o o u
	IC	L	W1	S	D1	RE	BS	OC3220		OP2202	OP1315	OP1325	OP1030	OP1630	OP1340	
P									=	>>	>>	>>	>>			#
M											>>	>>				#
K									>>	=	>>	>>	>>			
N																>>
S																
H																
SDKT13T308PER-OM	13.8			4.1			1.2		O		●					
SDKT13T320PER-OM	13.8			4.1			1.0		O		●					

● Stock available ○ Make-to-order

Profiling milling insert RM01 series

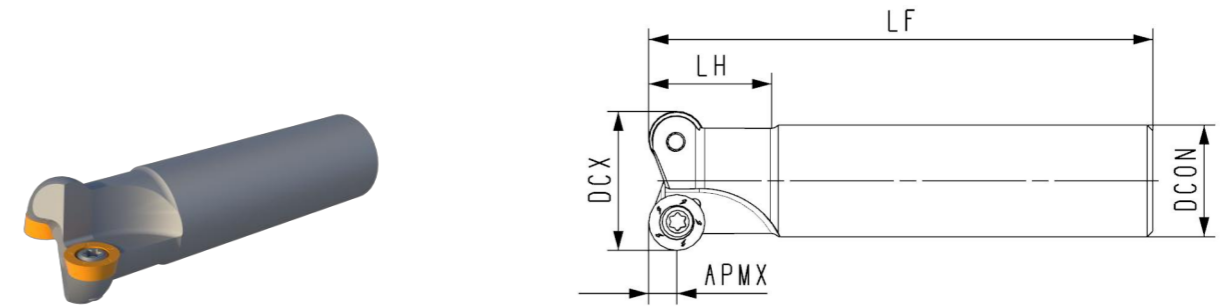

Type	stock	Number of flutes	Dimension						Interface	Adaptable Inserts	Accessories	Wrench
			DC	DCX	DCON	LF	LH	APMX				
RM01-P20-25-2-RP10-160-CR	●	2		25	20	160	45	5	P	RP*1003*	Pressing Plate: CR-R5 Screw: SA03510 SA04 09	T15P
RM01-P25-30-2-RP10-160-CR	●	3		30	25	160	45	5	P			
RM01-P32-35-3-RP10-160-CR	○	3		35	32	160	45	5	P			
RM01-P32-40-3-RP10-160-CR	●	3		40	32	160	45	5	P			
RM01-P32-40-4-RP10-160-CR	○	4		40	32	160	45	5	P			
RM01-P25-32-2-RP12-160-CR	○	2		32	25	160	50	6	P	RP*1204*	Pressing Plate: CR-R6 Screw: SA04 09	T15P
RM01-P25-32-3-RP12-160-CR	○	3		32	25	160	50	6	P			
RM01-P32-32-2-RP12-160-CR	●	2		32	32	160	45	6	P			
RM01-P32-32-3-RP12-160-CR	○	3		32	32	160	45	6	P			
RM01-P32-35-2-RP12-160-CR	○	2		35	32	160	50	6	P			
RM01-P32-40-3-RP12-200-CR	●	3		40	32	200	50	6	P			
RM01-P32-40-4-RP12-200-CR	○	4		40	32	200	50	6	P			

● Stock available ○ Make-to-order

Profiling milling insert RM01 series

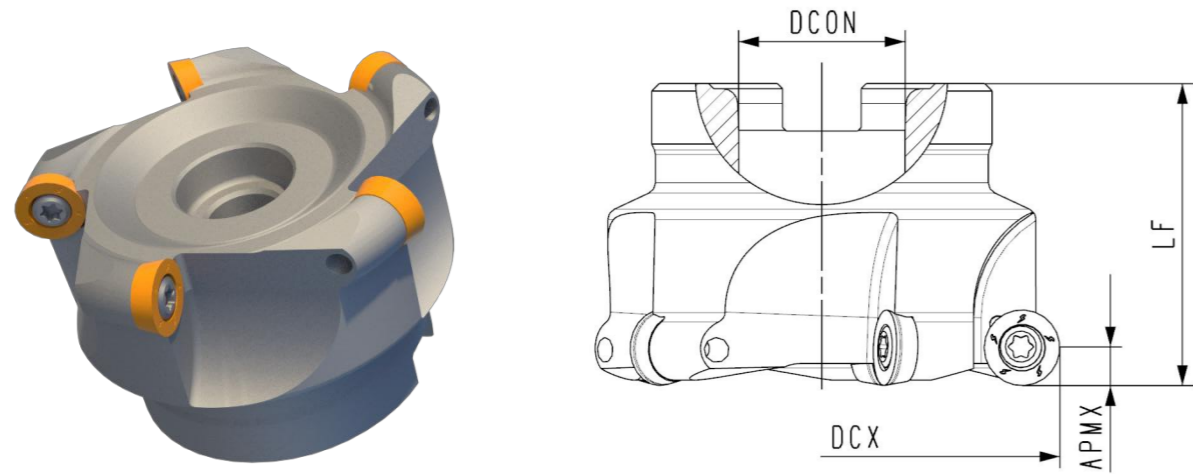

Type	stock	Number of flutes	Dimension						Interface	Adaptable Inserts	Accessories	Wrench
			DC	DCX	DCON	LF	LH	APMX				
RM01-A22-50-4-RP10-CR	●	4		50	22	50		5	A	RP*1003* Pressing Plate: CR-R5 Screw: SA03510 SA04 09	T15P	
RM01-A22-63-5-RP10-CR	○	5		63	22	50		5	A			
RM01-A27-80-6-RP10-CR	○	6		80	27	50		5	A			
RM01-B32-100-7-RP10-CR	○	7		100	32	50		5	B			
RM01-A22-50-4-RP12-CR	●	4		50	22	50		6	A	RP*1204* Pressing Plate: CR-R6 Screw: SA04 09	T15P	
RM01-A22-63-5-RP12-CR	●	5		63	22	50		6	A			
RM01-A27-80-6-RP12-CR	○	6		80	27	50		6	A			
RM01-B32-100-7-RP12-CR	○	7		100	32	50		6	B			

● Stock available ○ Make-to-order

RM01 milling insert

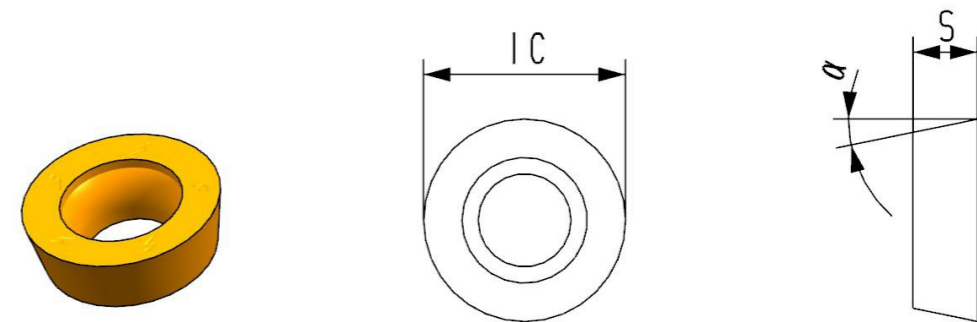

= stable cutting condition >> normal cutting condition # bad cutting condition

Material	Dimension								C V D	P V D						Универсальный OK434
	IC	L	W1	S	D1	α	BS	OC3220		OP2202	OP1315	OP1325	OP1030	OP1630	OP1340	
P									=	>>	>>	>>	>>		#	
M										>>	>>				#	
K									>>	=	>>	>>	>>			
N															>>	
S																
H																
RPMW1003MO-SD	10			3.18		11						○		●		
RPKT1204MO-SD	12			4.76		11						○		●		

● Stock available ○ Make-to-order

High feed milling insert HM192 series

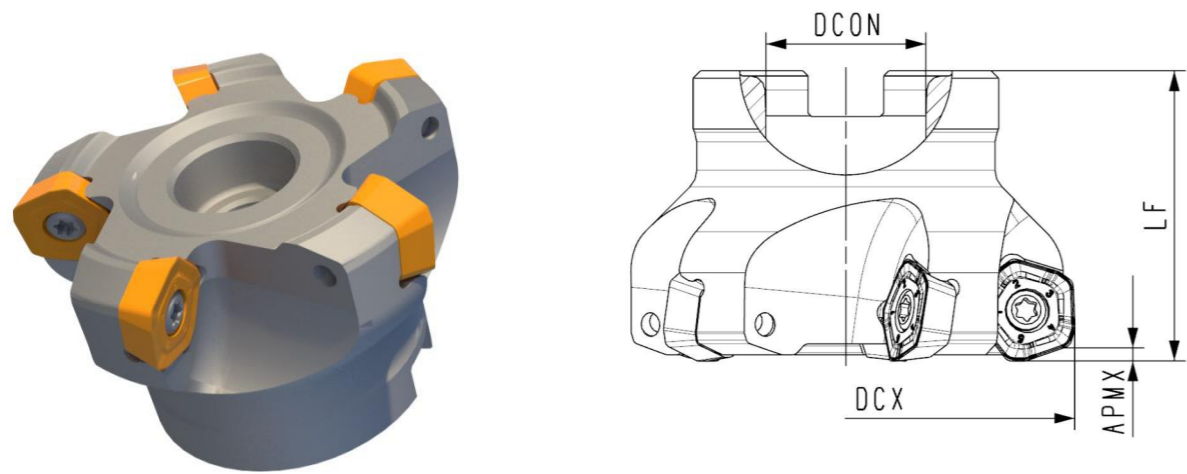

Type	stock	Number of flutes	Dimension						Interface	Adaptable Inserts	Screw	Wrench
			DC	DCX	DCON	LF	LH	APMX				
HM192-A22-50-4-PD13	●	4		50	22	40		1.9	A	PD*1305*	SA0411	T15P
HM192-A22-63-5-PD13	●	5		63	22	40		1.9	A			
HM192-A27-80-6-PD13	●	6		80	27	50		1.9	A			
HM192-B32-100-7-PD13	●	7		100	32	50		1.9	B			
HM192-B40-125-8-PD13	●	8		125	40	63		1.9	B			
HM192-C40-160-10-PD13	○	10		160	40	63		1.9	C			
HM192-C60-200-12-PD13	○	12		200	60	63		1.9	C			

● Stock available ○ Make-to-order

HM192 milling insert

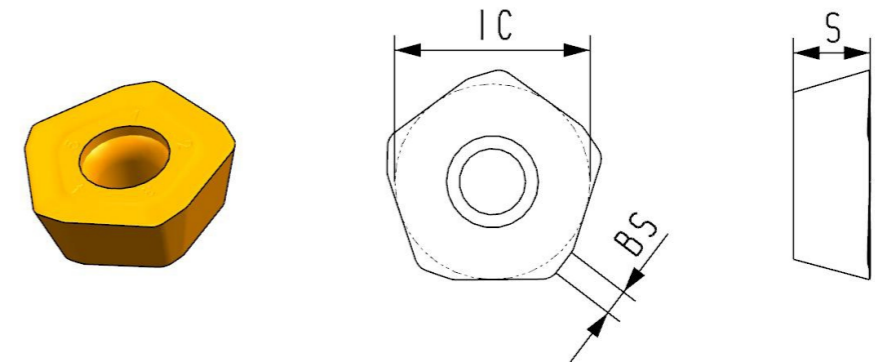

= stable cutting condition >> normal cutting condition # bad cutting condition

Material	Dimension								C V D	P V D					Un pe re o u n	
	IC	L	W1	S	D1	RE	BS	OC3220		OP2202	OP1315	OP1325	OP1030	OP1630		OP1340
P									=	>>	>>	>>	>>			#
M											>>	>>				#
K									>>	=	>>	>>	>>			
N																>>
S																
H																
PDMT1305ZDSR-SAM	13			5.1			1.7						●			

● Stock available ○ Make-to-order



C Drilling Tools

a Drilling Inserts 187-188

b Drilling Tools 189-196

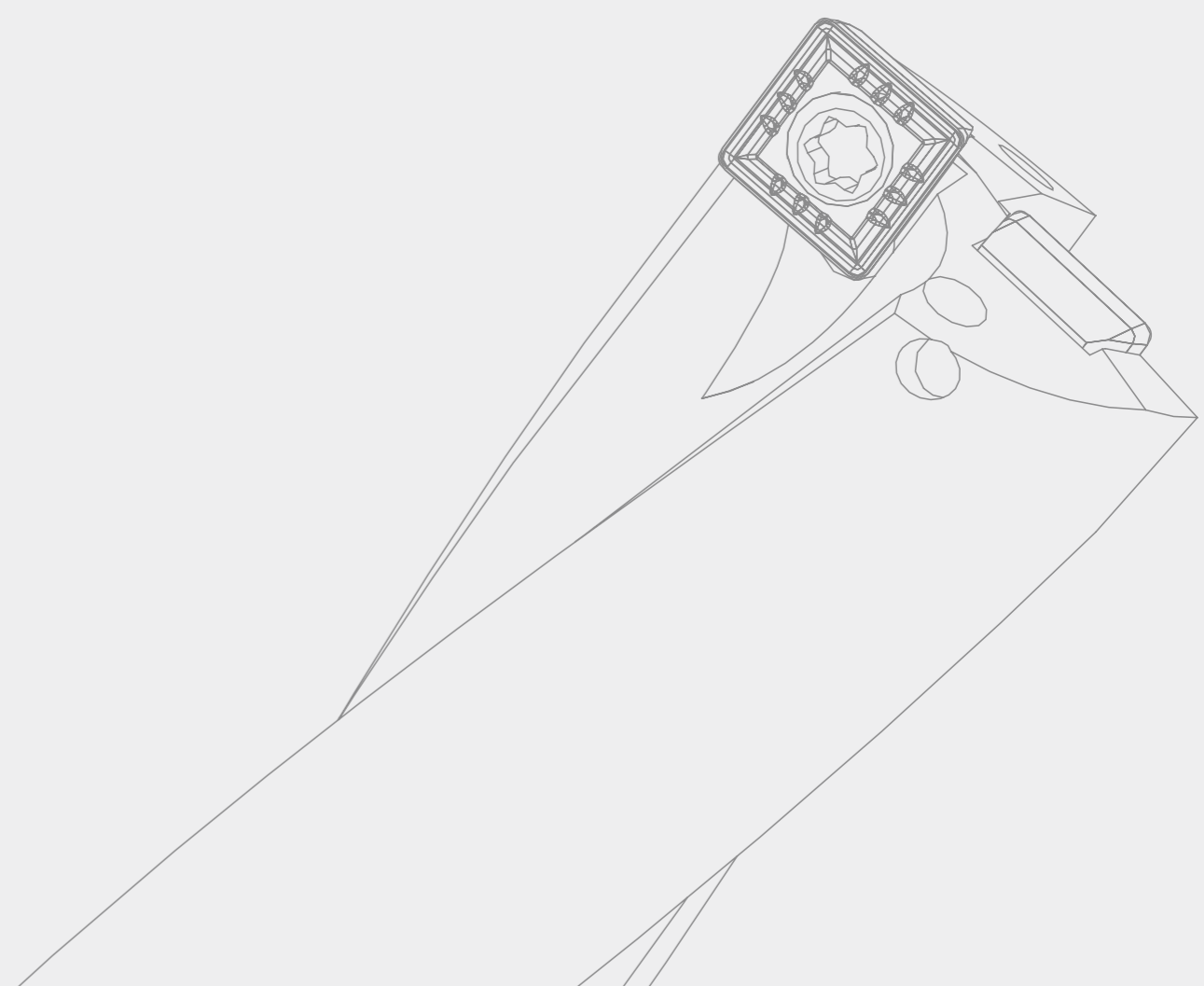

Indexable Shallow Drilling Insert List

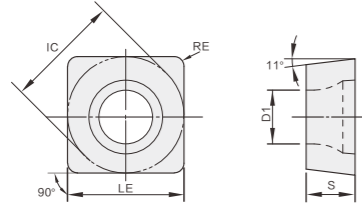

Insert Shape	Type	Dimensions(mm)					Grade	
		LE	IC	S	D1	RE	OP1215	OP1315
	SPGT050204-OPM	5	5	2.38	2.2	0.4	▲	●
	SPGT060204-OPM	6	6	2.38	2.6	0.4	▲	●
	SPGT07T308-OPM	7.94	7.94	3.97	2.8	0.8	▲	●
	SPGT090408-OPM	9.8	9.8	4.3	4.2	0.8	▲	●
	SPGT110408-OPM	11.5	11.5	4.76	4.4	0.8	▲	●
	SPGT140512-OPM	14.3	14.3	5.2	5.75	1.2	▲	●

Indexable Shallow Drilling Insert List

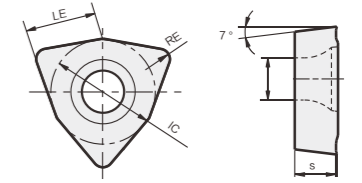

Insert Shape	Type	Dimensions(mm)					Grade	
		LE	IC	S	D1	RE	OP1215	OP1315
	WCMX030208-ZK	3.8	5.56	2.38	2.8	0.8	▲	●
	WCMX040208-ZK	4.3	6.35	2.38	3.1	0.8	▲	●
	WCMX050308-ZK	5.4	7.94	3.18	3.2	0.8	▲	●
	WCMX06T308-ZK	6.5	9.525	3.97	3.7	0.8	▲	●
	WCMX080412-ZK	8.7	12.7	4.76	4.3	1.2	▲	●

▲ Featured grade ● Optional grade

Indexable Drilling Inserts Tool Holder

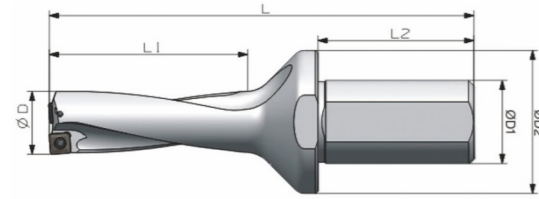

Type	Dimensions(mm)					
	D	ΦD ₁	ΦD ₂	L ₁	L ₂	L
UDR01-D13-W20-2X	13	20	25	32	50	96
UDR01-D14-W20-2X	14	20	25	34	50	98
UDR01-D15-W20-2X	15	20	25	36	50	100
UDR01-D16-W20-2X	16	20	25	38	50	102
UDR01-D17-W25-2X	17	25	32	40	56	118
UDR01-D18-W25-2X	18	25	32	42	56	120
UDR01-D19-W25-2X	19	25	32	44	56	121
UDR01-D20-W25-2X	20	25	32	46	56	123
UDR01-D21-W25-2X	21	25	32	48	56	125
UDR01-D22-W25-2X	22	25	32	50	56	128
UDR01-D23-W25-2X	23	25	32	52	60	130
UDR01-D24-W25-2X	24	25	32	54	60	132
UDR01-D25-W25-2X	25	25	32	56	60	134
UDR01-D26-W32-2X	26	32	40	58	60	136
UDR01-D27-W32-2X	27	32	40	60	60	138
UDR01-D28-W32-2X	28	32	40	62	60	147
UDR01-D29-W32-2X	29	32	40	64	60	149
UDR01-D30-W32-2X	30	32	40	66	60	151
UDR01-D31-W40-2X	31	40	50	68	60	153
UDR01-D32-W40-2X	32	40	50	70	60	155
UDR01-D33-W40-2X	33	40	50	72	60	157
UDR01-D34-W40-2X	34	40	50	74	60	174
UDR01-D35-W40-2X	35	40	50	76	60	176
UDR01-D36-W40-2X	36	40	50	78	60	178
UDR01-D37-W40-2X	37	40	50	80	70	180
UDR01-D38-W40-2X	38	40	50	82	70	182
UDR01-D39-W40-2X	39	40	50	84	70	184
UDR01-D40-W40-2X	40	40	50	86	70	186
UDR01-D41-W40-2X	41	40	50	88	70	188

Indexable Drilling Inserts Tool Holder

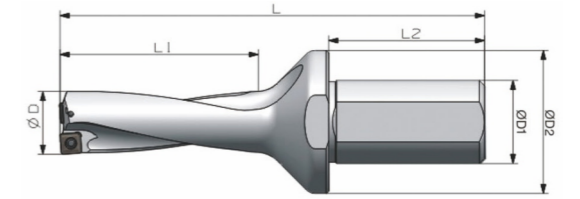

Type	Dimensions(mm)					
	D	ΦD ₁	ΦD ₂	L ₁	L ₂	L
UDR01-D42-W40-2X	42	40	60	90	70	200
UDR01-D43-W40-2X	43	40	60	92	70	202
UDR01-D44-W40-2X	44	40	60	94	70	204
UDR01-D45-W40-2X	45	40	60	96	70	206
UDR01-D46-W40-2X	46	40	60	98	70	208
UDR01-D47-W40-2X	47	40	60	100	70	210
UDR01-D48-W40-2X	48	40	60	102	70	212
UDR01-D49-W40-2X	49	40	60	104	70	214
UDR01-D50-W40-2X	50	40	60	106	70	216

Accessories

Insert	Diameter	Screw	Wrench
SPGT050204-OPM	13-16	L60 M2 × 4.3	T06
SPGT060204-OPM	17-21	L60 M2.2 × 5.5	T07
SPGT07T308-OPM	22-27	L60 M2.5 × 6.5	T08
SPGT090408-OPM	28-33	L60 M3.5 × 8	T15
SPGT110408-OPM	34-41	L60 M4 × 10	T15
SPGT140512-OPM	42-50	L60 M5 × 13	T20

Indexable Drilling Inserts Tool Holder

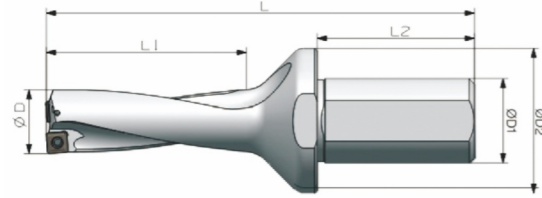

Type	Dimensions(mm)					
	D	ΦD ₁	ΦD ₂	L ₁	L ₂	L
UDR01-D13-W20-3X	13	20	25	44	50	111
UDR01-D14-W20-3X	14	20	25	47	50	114
UDR01-D15-W20-3X	15	20	25	50	50	127
UDR01-D16-W20-3X	16	20	25	53	50	120
UDR01-D17-W25-3X	17	25	32	56	56	135
UDR01-D18-W25-3X	18	25	32	59	56	138
UDR01-D19-W25-3X	19	25	32	62	56	140
UDR01-D20-W25-3X	20	25	32	65	56	143
UDR01-D21-W25-3X	21	25	32	68	56	146
UDR01-D22-W25-3X	22	25	32	71	56	149
UDR01-D23-W25-3X	23	25	32	74	60	153
UDR01-D24-W25-3X	24	25	32	77	60	156
UDR01-D25-W25-3X	25	25	32	80	60	159
UDR01-D26-W32-3X	26	32	40	83	60	162
UDR01-D27-W32-3X	27	32	40	86	60	165
UDR01-D28-W32-3X	28	32	40	89	60	168
UDR01-D29-W32-3X	29	32	40	92	60	178
UDR01-D30-W32-3X	30	32	40	95	60	181
UDR01-D31-W40-3X	31	40	50	98	60	184
UDR01-D32-W40-3X	32	40	50	101	60	187
UDR01-D33-W40-3X	33	40	50	104	60	190
UDR01-D34-W40-3X	34	40	50	107	60	193
UDR01-D35-W40-3X	35	40	50	110	60	196
UDR01-D36-W40-3X	36	40	50	113	60	199
UDR01-D37-W40-3X	37	40	50	117	70	217
UDR01-D38-W40-3X	38	40	50	119	70	220
UDR01-D39-W40-3X	39	40	50	122	70	223
UDR01-D40-W40-3X	40	40	50	125	70	231
UDR01-D41-W40-3X	41	40	50	128	70	229

Indexable Drilling Inserts Tool Holder

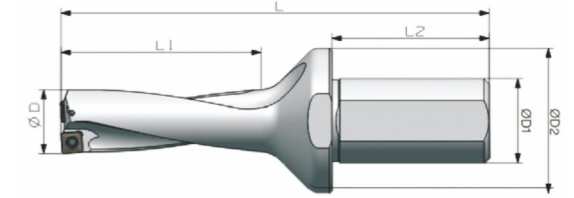

Type	Dimensions(mm)					
	D	ΦD ₁	ΦD ₂	L ₁	L ₂	L
UDR01-D42-W40-3X	42	40	60	131	70	232
UDR01-D43-W40-3X	43	40	60	134	70	240
UDR01-D44-W40-3X	44	40	60	138	70	248
UDR01-D45-W40-3X	45	40	60	141	70	251
UDR01-D46-W40-3X	46	40	60	144	70	254
UDR01-D47-W40-3X	47	40	60	147	70	257
UDR01-D48-W40-3X	48	40	60	149	70	260
UDR01-D49-W40-3X	49	40	60	152	70	263
UDR01-D50-W40-3X	50	40	60	155	70	266

Accessories

Insert	Diameter	Screw	Wrench
SPGT050204-OPM	13-16	L60 M2 × 4.3	T06
SPGT060204-OPM	17-21	L60 M2.2 × 5.5	T07
SPGT07T308-OPM	22-27	L60 M2.5 × 6.5	T08
SPGT090408-OPM	28-33	L60 M3.5 × 8	T15
SPGT110408-OPM	34-41	L60 M4 × 10	T15
SPGT140512-OPM	42-50	L60 M5 × 13	T20

Indexable Drilling Inserts Tool Holder

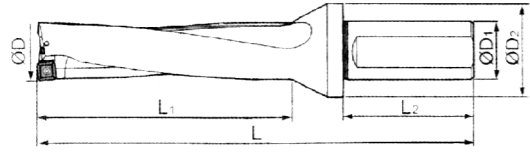

Type	Dimensions(mm)					
	ΦD	ΦD ₁	ΦD ₂	L ₁	L ₂	L
UDR01-D13-W20-4X	13	20	25	57	50	124
UDR01-D14-W20-4X	14	20	25	61	50	128
UDR01-D15-W20-4X	15	20	25	65	50	132
UDR01-D16-W20-4X	16	20	25	69	50	136
UDR01-D17-W25-4X	17	25	32	73	56	152
UDR01-D18-W25-4X	18	25	32	77	56	156
UDR01-D19-W25-4X	19	25	32	81	56	159
UDR01-D20-W25-4X	20	25	32	85	56	163
UDR01-D21-W25-4X	21	25	32	89	56	167
UDR01-D22-W25-4X	22	25	32	93	56	172
UDR01-D23-W32-4X	23	25	40	97	56	176
UDR01-D24-W32-4X	24	25	40	101	56	180
UDR01-D25-W32-4X	25	25	40	105	56	184
UDR01-D26-W32-4X	26	32	40	109	56	188
UDR01-D27-W32-4X	27	32	40	113	56	192
UDR01-D28-W32-4X	28	32	40	118	60	203
UDR01-D29-W32-4X	29	32	40	122	60	207
UDR01-D30-W32-4X	30	32	40	125	60	211
UDR01-D31-W40-4X	31	40	50	129	60	215
UDR01-D32-W40-4X	32	40	50	133	60	219
UDR01-D33-W40-4X	33	40	50	137	70	223
UDR01-D34-W40-4X	34	40	50	142	70	242
UDR01-D35-W40-4X	35	40	50	146	70	246
UDR01-D36-W40-4X	36	40	50	150	70	250
UDR01-D37-W40-4X	37	40	50	154	70	254
UDR01-D38-W40-4X	38	40	50	158	70	258
UDR01-D39-W40-4X	39	40	50	162	70	262
UDR01-D40-W40-4X	40	40	50	166	70	266
UDR01-D41-W40-4X	41	40	50	170	70	270

Indexable Drilling Inserts Tool Holder

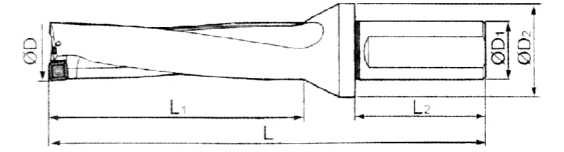

Type	Dimensions(mm)					
	D	ΦD ₁	ΦD ₂	L ₁	L ₂	L
UDR01-D42-W40-4X	42	40	60	174	70	284
UDR01-D43-W40-4X	43	40	60	178	70	288
UDR01-D44-W40-4X	44	40	60	182	70	292
UDR01-D45-W40-4X	45	40	60	186	70	296
UDR01-D46-W40-4X	46	40	60	190	70	300
UDR01-D47-W40-4X	47	40	60	194	70	304
UDR01-D48-W40-4X	48	40	60	198	70	307
UDR01-D49-W40-4X	49	40	60	202	70	312
UDR01-D50-W40-4X	50	40	60	206	70	316

Accessories

Insert	Diameter	Screw	Wrench
SPGT050204-OPM	13-16	L60 M2 × 4.3	T06
SPGT060204-OPM	17-21	L60 M2.2 × 5.5	T07
SPGT07T308-OPM	22-27	L60 M2.5 × 6.5	T08
SPGT090408-OPM	28-33	L60 M3.5 × 8	T15
SPGT110408-OPM	34-41	L60 M4 × 10	T15
SPGT140512-OPM	42-50	L60 M5 × 13	T20

Indexable Drilling Inserts Tool Holder

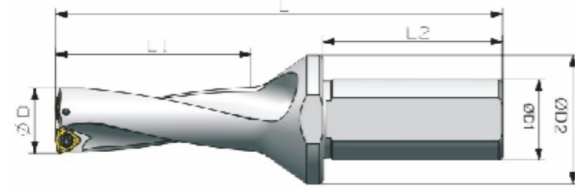

Type	Dimensions(mm)					
	ΦD	ΦD ₁	ΦD ₂	L ₁	L ₂	L
UDR02-D16-W25-3X	16	25	32	52	56	129
UDR02-D17-W25-3X	17	25	32	55	56	133
UDR02-D18-W25-3X	18	25	32	58	56	137
UDR02-D19-W25-3X	19	25	32	61	56	140
UDR02-D20-W25-3X	20	25	32	64	56	143
UDR02-D21-W25-3X	21	25	32	67	56	153
UDR02-D22-W25-3X	22	25	32	70	56	156
UDR02-D23-W25-3X	23	25	32	73	56	159
UDR02-D24-W25-3X	24	25	32	76	56	162
UDR02-D25-W25-3X	25	25	32	79	56	165
UDR02-D26-W32-3X	26	32	40	83	60	176
UDR02-D27-W32-3X	27	32	40	86	60	180
UDR02-D28-W32-3X	28	32	40	89	60	184
UDR02-D29-W32-3X	29	32	40	92	60	188
UDR02-D30-W32-3X	30	32	40	95	60	192
UDR02-D31-W40-3X	31	40	50	98	70	203
UDR02-D32-W40-3X	32	40	50	101	70	206
UDR02-D33-W40-3X	33	40	50	104	70	209
UDR02-D34-W40-3X	34	40	50	107	70	212
UDR02-D35-W40-3X	35	40	50	110	70	215
UDR02-D36-W40-3X	36	40	50	113	70	218
UDR02-D37-W40-3X	37	40	50	116	70	221
UDR02-D38-W40-3X	38	40	50	119	70	225
UDR02-D39-W40-3X	39	40	50	122	70	228
UDR02-D40-W40-3X	40	40	50	125	70	231
UDR02-D41-W40-3X	41	40	50	128	70	234
UDR02-D42-W40-3X	42	40	60	131	70	239
UDR02-D43-W40-3X	43	40	60	134	70	242
UDR02-D44-W40-3X	44	40	60	137	70	245
UDR02-D45-W40-3X	45	40	60	140	70	248
UDR02-D46-W40-3X	46	40	60	143	70	251
UDR02-D47-W40-3X	47	40	60	146	70	253

Indexable Drilling Inserts Tool Holder

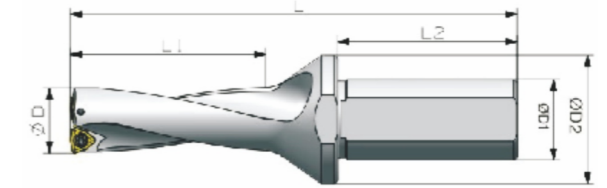

Type	Dimensions(mm)					
	D	ΦD ₁	ΦD ₂	L ₁	L ₂	L
UDR02-D48-W40-3X	48	40	60	149	70	255
UDR02-D49-W40-3X	49	40	60	152	70	257
UDR02-D50-W40-3X	50	40	60	155	70	259
UDR02-D51-W50-3X	51	50	60	158	70	261
UDR02-D52-W50-3X	52	50	60	161	70	263
UDR02-D53-W50-3X	53	50	60	164	70	265
UDR02-D54-W50-3X	54	50	60	167	70	267
UDR02-D55-W50-3X	55	50	60	170	70	269
UDR02-D56-W50-3X	56	50	60	173	70	271
UDR02-D57-W50-3X	57	50	60	176	70	273
UDR02-D58-W50-3X	58	50	60	179	70	275

Accessories

Insert	Diameter	Screw	Wrench
WCMX030208-ZK	16-20	L60 M2.5 × 6.5	T08
WCMX040208-ZK	21-25	L60 M2.5 × 6.5	T08
WCMX050308-ZK	26-30	L60 M3 × 8	T10
WCMX06T308-ZK	31-41	L60 M3.5 × 8	T15
WCMX080412-ZK	42-58	L60 M4 × 10	T15

D Solid End Mill

a OMPQ General purpose series 200-213

b OMPX series, high performance 214-227
and wide application range

c OMH series for quenched steel 228-240

d OMHH series for High-hardened steel 241-252

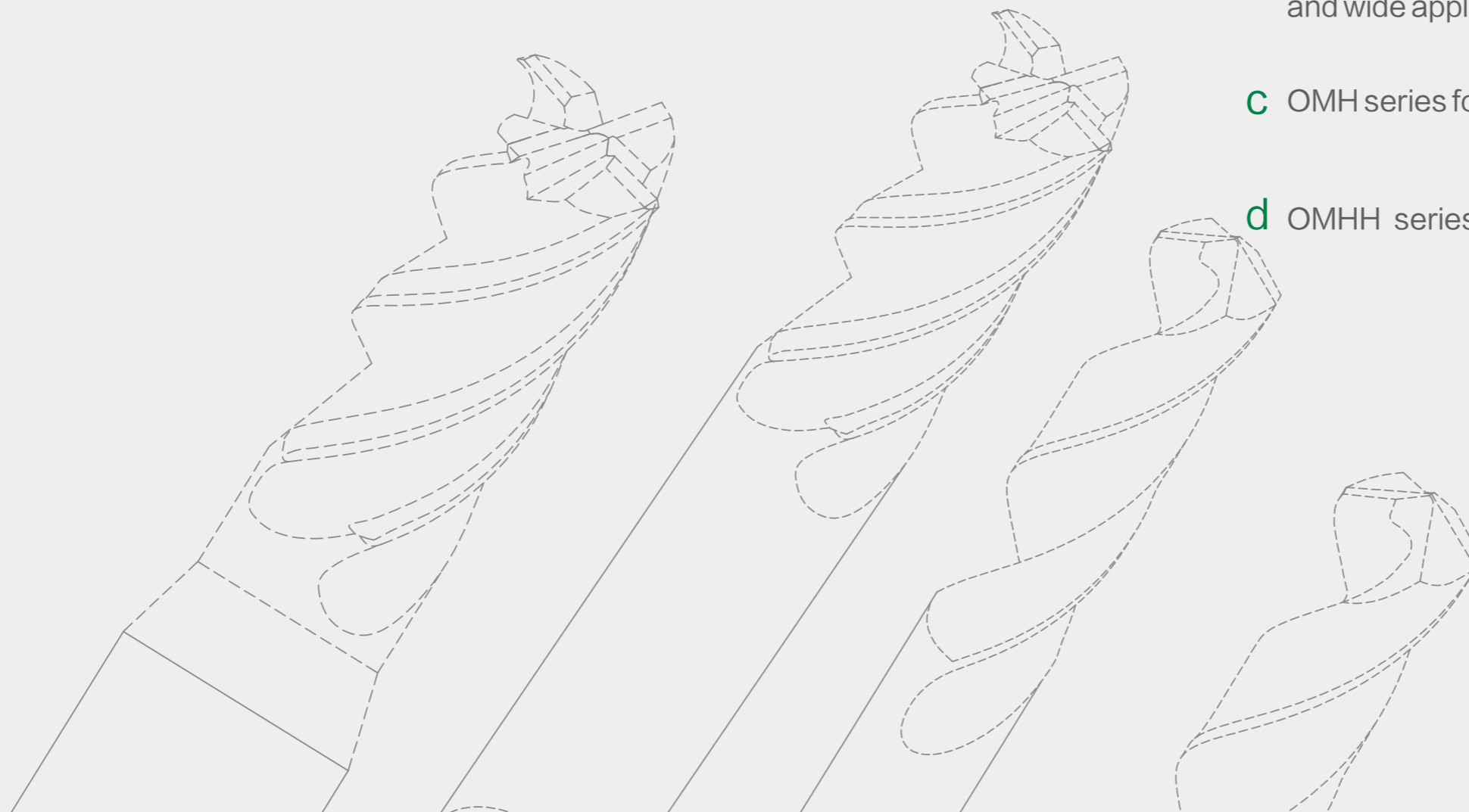

Standard End Mills Naming Rules

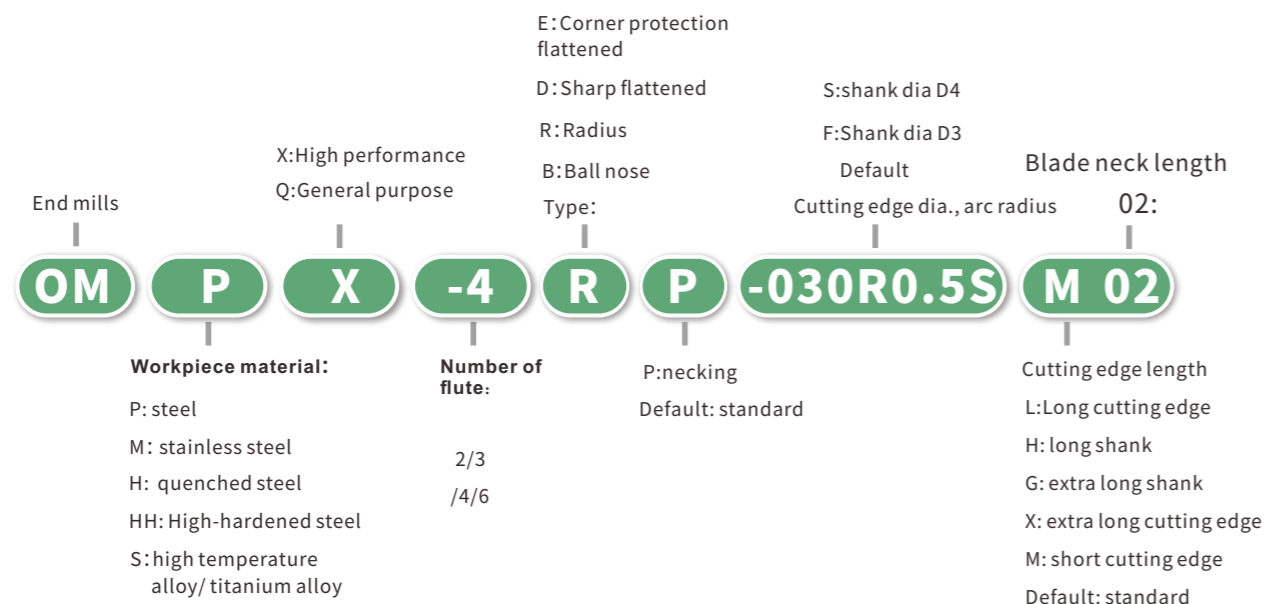

OMPQ General purpose series

Product features and application range

This series of products are suitable for rough machining to semi-finishing of workpiece materials with hardness <HRC45.

- ① Adopt the latest high temperature resistance, wear resistance coating with the new formula of carbide substrate, able to adapt to more working condition;
- ② The edge is designed to take into account the cutting edge strength and wear resistance of the curved flank surface structure, improve the tool life;
- ③ The new upgraded spiral flute not only ensures enough chip space, but also improves the strength and rigidity of the edge. It is suitable for machining from finishing to rough machining, and the tool performance is more comprehensive.



OMPQ-4E 4 flute straight shank flat end mill

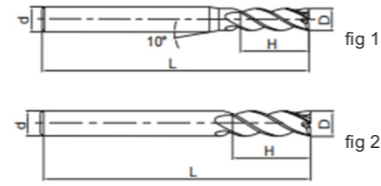
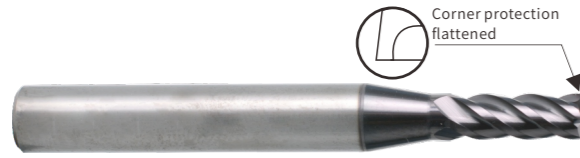

Suitable for machining side and shallow slot wide application.

helical angle $\angle 38^\circ$ diameter tolerance $D1\sim D6_{-0.02}^0 / D6\sim D14_{-0.025}^0 / D15\sim D20_{-0.03}^0$



OMPQ-4EL 4 flute long cutting edge flat end mill

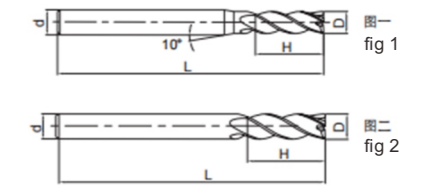

● OMPQ-4E long cutting edge series

螺旋角 $\angle 38^\circ$ 直径公差 $D1\sim D6_{-0.02}^0 / D6\sim D14_{-0.025}^0 / D15\sim D20_{-0.03}^0$



part number	dimension (mm)				Number of flutes	Geometry	stock
	D	d	H	L			
OMPQ-4E-010F	1.0	3	3	50	4	fig 1	▲
OMPQ-4E-010S	1.0	4	3	50	4	fig 1	●
OMPQ-4E-010	1.0	6	3	50	4	fig 1	●
OMPQ-4E-015F	1.5	3	4	50	4	fig 1	▲
OMPQ-4E-015S	1.5	4	4	50	4	fig 1	●
OMPQ-4E-015	1.5	6	4	50	4	fig 1	●
OMPQ-4E-020F	2.0	3	6	50	4	fig 1	▲
OMPQ-4E-020S	2.0	4	6	50	4	fig 1	●
OMPQ-4E-020	2.0	6	6	50	4	fig 1	●
OMPQ-4E-025F	2.5	3	8	50	4	fig 1	▲
OMPQ-4E-025S	2.5	4	8	50	4	fig 1	●
OMPQ-4E-025	2.5	6	8	50	4	fig 1	●
OMPQ-4E-030F	3.0	3	8	50	4	fig 2	▲
OMPQ-4E-030S	3.0	4	8	50	4	fig 1	●
OMPQ-4E-030	3.0	6	8	50	4	fig 1	●
OMPQ-4E-035S	3.5	4	10	50	4	fig 1	●
OMPQ-4E-035	3.5	6	10	50	4	fig 1	●
OMPQ-4E-040S	4.0	4	11	50	4	fig 2	●
OMPQ-4E-040	4.0	6	11	50	4	fig 1	●
OMPQ-4E-045	4.5	6	11	50	4	fig 1	●
OMPQ-4E-050	5.0	6	13	50	4	fig 1	●
OMPQ-4E-055	5.5	6	16	50	4	fig 1	●
OMPQ-4E-060	6.0	6	16	50	4	fig 2	●
OMPQ-4E-070	7.0	8	20	60	4	fig 1	●
OMPQ-4E-080	8.0	8	20	60	4	fig 2	●
OMPQ-4E-090	9.0	10	22	75	4	fig 1	●
OMPQ-4E-100	10.0	10	25	75	4	fig 2	●
OMPQ-4E-110	11.0	12	26	75	4	fig 1	●
OMPQ-4E-120	12.0	12	30	75	4	fig 2	●
OMPQ-4E-140	14.0	14	32	75	4	fig 2	●
OMPQ-4E-160	16.0	16	45	100	4	fig 2	●
OMPQ-4E-180	18.0	18	45	100	4	fig 2	●
OMPQ-4E-200	20.0	20	45	100	4	fig 2	●

订货号 part number	基本尺寸 (mm) dimension (mm)				齿数 (z) Number of flutes	形式 Geometry	库存 stock
	D	d	H	L			
OMPQ-4E-030L	3.0	6	12	75	4	图一 fig 1	●
OMPQ-4E-040L	4.0	6	15	75	4	图一 fig 1	●
OMPQ-4E-050L	5.0	6	20	75	4	图一 fig 1	●
OMPQ-4E-060L	6.0	6	20	75	4	图二 fig 2	●
OMPQ-4E-080L	8.0	8	25	100	4	图二 fig 2	●
OMPQ-4E-100L	10.0	10	30	100	4	图二 fig 2	●
OMPQ-4E-120L	12.0	12	35	100	4	图二 fig 2	●
OMPQ-4E-140L	14.0	14	40	100	4	图二 fig 2	●
OMPQ-4E-160L	16.0	16	50	150	4	图二 fig 2	●
OMPQ-4E-200L	20.0	20	55	150	4	图二 fig 2	●

● Stock available ▲ Make-to-order

OMPQ-4EX 4 flute extra long cutting edge flat end mill

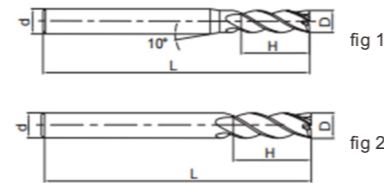
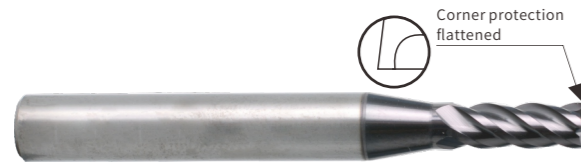

OMPQ-4E extra long cutting edge series, Suitable for deep side machining.

helical angle $\angle 38^\circ$ diameter tolerance $D1\sim D6_{-0.02}^0 / D6\sim D14_{-0.025}^0 / D15\sim D20_{-0.03}^0$



part number	dimension (mm)				Number of flutes	Geometry	stock
	D	d	H	L			
OMPQ-4E-030X	3.0	6	20	75	4	fig 1	▲
OMPQ-4E-040X	4.0	6	25	75	4	fig 1	▲
OMPQ-4E-050X	5.0	6	30	75	4	fig 1	▲
OMPQ-4E-060X	6.0	6	30	75	4	fig 2	▲
OMPQ-4E-080X	8.0	8	40	100	4	fig 2	▲
OMPQ-4E-100X	10.0	10	50	110	4	fig 2	▲
OMPQ-4E-120X	12.0	12	50	110	4	fig 2	▲
OMPQ-4E-160X	16.0	16	70	150	4	fig 2	▲
OMPQ-4E-200X	20.0	20	75	150	4	fig 2	▲

Workpiece material (○suitable, ●very suitable)

Carbon steel	Alloy steel	Pre-hardened steel, Hardened steel				Stainless steel	Cast iron, nodular cast iron	copper alloy	Aluminum alloy	titanium alloy	Heat resistant alloy
		~40HRC	~50HRC	~55HRC	~68HRC						
○	○	○	○			○	○				

OMPQ-4EX recommend cutting parameters

Workpiece material	Cast iron/nodular cast		Carbon steel, Alloy steel ~750N/mm2		Carbon steel, Alloy steel ~30HRC		Pre-hardened steel, hardened and tempered steel ~40HRC		Stainless steel		Pre-hardened steel, hardened and tempered steel ~50HRC	
	Diameter (mm)	Rotating speed (min ⁻¹)	Feedspeed (mm/min)	Rotating speed (min ⁻¹)	Feedspeed (mm/min)	Rotating speed (min ⁻¹)	Feedspeed (mm/min)	Rotating speed (min ⁻¹)	Feedspeed (mm/min)	Rotating speed (min ⁻¹)	Feedspeed (mm/min)	Rotating speed (min ⁻¹)
6	5800	475	5800	475	5300	430	4250	340	2650	70	3600	290
8	4400	475	4400	475	4000	430	3180	340	2000	70	2700	290
10	3500	460	3500	460	3200	420	2550	330	1600	70	2150	280
12	2900	460	2900	460	2650	420	2120	330	1350	70	1800	280
16	2200	430	2200	430	2000	390	1590	315	1000	65	1350	260
20	1750	430	1750	430	1600	385	1270	310	800	60	1050	255

max. cutting depth

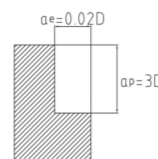

OMPQ-4D Sharp flattened 4 flute straight shank flat end mill

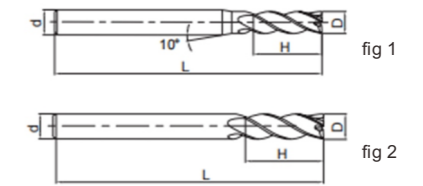

Suitable for side milling and shallow slot machining.

helical angle $\angle 38^\circ$ diameter tolerance $D1\sim D6_{-0.02}^0 / D6\sim D14_{-0.025}^0 / D15\sim D20_{-0.03}^0$



part number	dimension (mm)				Number of flutes	Geometry	stock
	D	d	H	L			
OMPQ-4D-010S	1.0	4	3	50	4	fig 1	▲
OMPQ-4D-010	1.0	6	3	50	4	fig 1	▲
OMPQ-4D-015S	1.5	4	4	50	4	fig 1	▲
OMPQ-4D-015	1.5	6	4	50	4	fig 1	▲
OMPQ-4D-020S	2.0	4	6	50	4	fig 1	▲
OMPQ-4D-020	2.0	6	6	50	4	fig 1	▲
OMPQ-4D-025S	2.5	4	8	50	4	fig 1	▲
OMPQ-4D-025	2.5	6	8	50	4	fig 1	▲
OMPQ-4D-030S	3.0	4	8	50	4	fig 1	▲
OMPQ-4D-030	3.0	6	8	50	4	fig 1	▲
OMPQ-4D-035	3.5	6	10	50	4	fig 1	▲
OMPQ-4D-040S	4.0	4	11	50	4	fig 2	●
OMPQ-4D-040	4.0	6	11	50	4	fig 1	▲
OMPQ-4D-045	4.5	6	11	50	4	fig 1	▲
OMPQ-4D-050	5.0	6	13	50	4	fig 1	▲
OMPQ-4D-055	5.5	6	16	50	4	fig 1	▲
OMPQ-4D-060	6.0	6	16	50	4	fig 2	●
OMPQ-4D-070	7.0	8	20	60	4	fig 1	▲
OMPQ-4D-080	8.0	8	20	60	4	fig 2	●
OMPQ-4D-090	9.0	10	22	75	4	fig 1	▲
OMPQ-4D-100	10.0	10	25	75	4	fig 2	●
OMPQ-4D-110	11.0	12	26	75	4	fig 1	▲
OMPQ-4D-120	12.0	12	30	75	4	fig 2	●
OMPQ-4D-140	14.0	14	32	75	4	fig 2	▲
OMPQ-4D-160	16.0	16	45	100	4	fig 2	●
OMPQ-4D-180	18.0	18	45	100	4	fig 2	▲
OMPQ-4D-200	20.0	20	45	100	4	fig 2	▲

● Stock available ▲ Make-to-order

Workpiece material (○suitable, ●very suitable)

Carbon steel	Alloy steel	Pre-hardened steel, Hardened steel				Stainless steel	Cast iron, nodular cast iron	copper alloy	Aluminum alloy	titanium alloy	Heat resistant alloy
		~40HRC	~50HRC	~55HRC	~68HRC						
○	○	○	○			○	○				

OMPQ-4D recommend cutting parameters

Workpiece material	Cast iron/nodular cast		Carbon steel, Alloy steel ~750N/mm2		Carbon steel, Alloy steel ~30HRC		Pre-hardened steel, hardened and tempered steel ~40HRC		Stainless steel		Pre-hardened steel, hardened and tempered steel ~50HRC	
	Diameter (mm)	Rotating speed (min ⁻¹)	Feedspeed (mm/min)	Rotating speed (min ⁻¹)	Feedspeed (mm/min)	Rotating speed (min ⁻¹)	Feedspeed (mm/min)	Rotating speed (min ⁻¹)	Feedspeed (mm/min)	Rotating speed (min ⁻¹)	Feedspeed (mm/min)	Rotating speed (min ⁻¹)
1	20000	160	20000	160	20000	125	20000	125	20000	55	20000	95
2	15000	250	15000	250	15000	230	15000	230	11150	65	13000	140
3	14000	430	14000	430	13000	400	10600	400	7500	80	8500	260
4	10800	440	10800	440	10000	400	8000	400	5500	80	6500	265
5	8200	460	8200	460	7600	420	6400	420	4500	80	5000	280
6	7000	470	7000	470	6400	435	5300	435	3700	85	4200	285
8	5200	465	5200	465	4800	430	4000	430	2800	85	3200	290
10	4200	460	4200	460	3800	420	3200	420	2200	85	2500	275
12	3500	460	3500	460	3200	420	2650	420	1850	80	2100	275
14	3000	430	3000	430	2700	400	2300	400	1600	80	1800	260
16	2600	430	2600	430	2400	400	2000	400	1400	80	1600	260
18	2300	420	2300	420	2100	390	1800	390	1250	70	1400	255
20	2050	420	2050	420	1900	390	1600	390	1100	70	1250	255

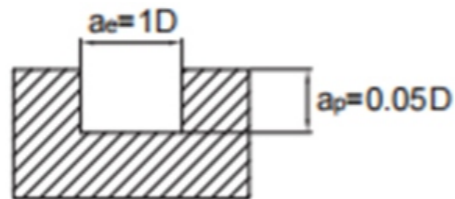
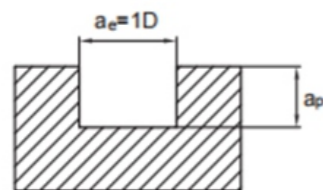
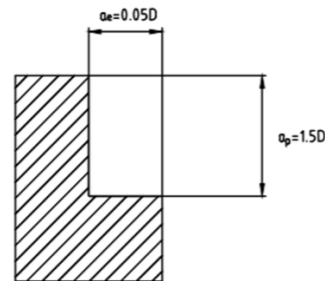
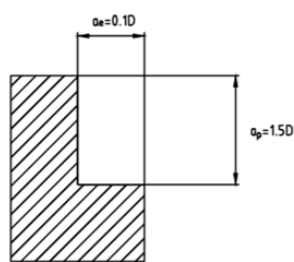

刀具直径 tool diameter	Ap
Φ 1 ≤ D ≤ Φ 3	0.15D
Φ 3 ≤ D	0.3D

- The above table shows the standard value of side milling. When milling slot, 50%~70% of rotating speed and 40%~60% of feed speed stated above are recommended as standard.
- Please select high-precision machine and tool holder.
- Please use air blow or cutting liquid with high mist retardant property.
- Down milling is recommended in the case of side milling.
- When the machine rigidity and workpiece fixture stability is low, vibration and abnormal noise may be generated. Please reduce the rotating speed and feed speed stated above correspondingly.
- Make overhang of tool as short as possible in conditions of non-interference.

OMPQ-4EH/G 4 flute long shank/ extra long shank flat end mill

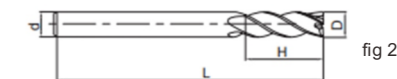
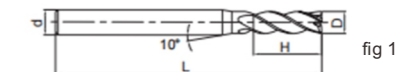

OMPQ-4E long and extra long shank series for deep cavity milling.

helical angle $\angle 38^\circ$ diameter tolerance $D1 \sim D6 \begin{smallmatrix} 0 \\ -0.02 \end{smallmatrix} / D6 \sim D14 \begin{smallmatrix} 0 \\ -0.025 \end{smallmatrix} / D15 \sim D20 \begin{smallmatrix} 0 \\ -0.03 \end{smallmatrix}$



part number	dimension (mm)				Number of flutes	Geometry	stock
	D	d	H	L			
OMPQ-4E-030SH	3.0	4	8	75	4	fig 1	▲
OMPQ--4E-030H	3.0	6	8	75	4	fig 1	▲
OMPQ-4E-040SH	4.0	4	11	75	4	fig 2	▲
OMPQ-4E-040H	4.0	6	11	75	4	fig 1	▲
OMPQ-4E-060H	6.0	6	16	75	4	fig 2	▲
OMPQ-4E-060G	6.0	6	16	100	4	fig 2	▲
OMPQ-4E-080H	8.0	8	20	75	4	fig 2	▲
OMPQ-4E-080G	8.0	8	20	100	4	fig 2	▲
OMPQ-4E-100H	10.0	10	25	100	4	fig 2	▲
OMPQ-4E-100G	10.0	10	25	150	4	fig 2	▲
OMPQ-4E-120H	12.0	12	30	100	4	fig 2	▲
OMPQ-4E-120G	12.0	12	30	150	4	fig 2	▲

● Stock available ▲ Make-to-order

Workpiece material (○suitable, ◎very suitable)

Carbon steel	Alloy steel	Pre-hardened steel, Hardened steel				Stainless steel	Cast iron, nodular cast iron	copper alloy	Aluminum alloy	titanium alloy	Heat resistant alloy
		~40HRC	~50HRC	~55HRC	~68HRC						
◎	◎	◎	○			○	◎				

OMPQ-2B 2 flutes straight shank ball head end mill

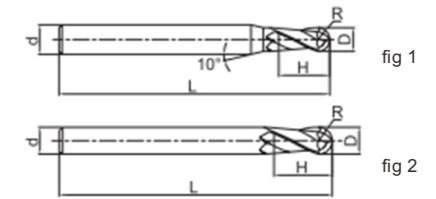

Suitable for profile milling, and high speed machining, with wide range of applications.

helical angle $\angle 30^\circ$ diameter D tolerance 0 $R \pm 0.005$



part number	dimension (mm)					Number of flutes	Geometry	stock
	D	R	d	H	L			
OMPQ-2B-010R0.5S	1	0.5	4	2	50	2	fig 1	▲
OMPQ-2B-010R0.5	1	0.5	6	2	50	2	fig 1	▲
OMPQ-2B-015R0.75S	1.5	0.75	4	3	50	2	fig 1	▲
OMPQ-2B-015R0.75	1.5	0.75	6	3	50	2	fig 1	▲
OMPQ-2B-020R1.0F	2	1	3	4	50	2	fig 1	▲
OMPQ-2B-020R1.0S	2	1	4	4	50	2	fig 1	▲
OMPQ-2B-020R1.0	2	1	6	4	50	2	fig 1	▲
OMPQ-2B-025R1.25F	2.5	1.25	3	5	50	2	fig 1	▲
OMPQ-2B-025R1.25S	2.5	1.25	4	5	50	2	fig 1	▲
OMPQ-2B-025R1.25	2.5	1.25	6	5	50	2	fig 1	▲
OMPQ-2B-030R1.5F	3	1.5	3	6	50	2	fig 2	▲
OMPQ-2B-030R1.5S	3	1.5	4	6	50	2	fig 1	●
OMPQ-2B-030R1.5	3	1.5	6	6	50	2	fig1	●
OMPQ-2B-035R1.75S	3.5	1.75	4	8	50	2	fig 1	●
OMPQ-2B-035R1.75	3.5	1.75	6	8	50	2	fig 1	●
OMPQ-2B-040R2.0S	4	2	4	8	50	2	fig 2	●
OMPQ-2B-040R2.0	4	2	6	8	50	2	fig 1	●
OMPQ-2B-050R2.5	5	2.5	6	10	50	2	fig 1	●
OMPQ-2B-055R2.75	5.5	2.75	6	12	50	2	fig 1	●
OMPQ-2B-060R3.0	6	3	6	12	50	2	fig 2	●
OMPQ-2B-070R3.5	7	3.5	8	14	60	2	fig 1	●
OMPQ-2B-080R4.0	8	4	8	16	60	2	fig 2	●
OMPQ-2B-090R4.5	9	4.5	10	18	75	2	fig 1	●
OMPQ-2B-100R5.0	10	5	10	20	75	2	fig 2	●
OMPQ-2B-120R6.0	12	6	12	24	75	2	fig 2	●
OMPQ-2B-140R7.0	14	7	14	28	75	2	fig 2	●
OMPQ-2B-160R8.0	16	8	16	32	100	2	fig 2	●
OMPQ-2B-200R10.0	20	10	20	40	100	2	fig 2	●

● Stock available ▲ Make-to-order

OMPQ-4E/4EL,G,H recommend cutting parameters

Workpiece material	Cast iron/nodular cast		Carbon steel, Alloy steel ~750N/mm2		Carbon steel, Alloy steel ~30HRC		Pre-hardened steel, hardened and tempered steel ~40HRC		Stainless steel		Pre-hardened steel, hardened and tempered steel ~50HRC	
	Diameter (mm)	Rotating speed (min ⁻¹)	Feedspeed (mm/min)	Rotating speed (min ⁻¹)	Feedspeed (mm/min)	Rotating speed (min ⁻¹)	Feedspeed (mm/min)	Rotating speed (min ⁻¹)	Feedspeed (mm/min)	Rotating speed (min ⁻¹)	Feedspeed (mm/min)	Rotating speed (min ⁻¹)
1	20000	250	20000	250	20000	200	20000	200	20000	90	20000	150
2	15000	400	15000	400	15000	360	15000	350	11150	100	13000	225
3	14000	680	14000	680	13000	630	10600	525	7500	120	8500	410
4	10800	700	10800	700	10000	640	8000	535	5500	125	6500	420
5	8200	730	8200	730	7600	670	6400	560	4500	125	5000	440
6	7000	750	7000	750	6400	690	5300	575	3700	135	4200	450
8	5200	740	5200	740	4800	680	4000	565	2800	135	3200	460
10	4200	730	4200	730	3800	670	3200	560	2200	135	2500	435
12	3500	730	3500	730	3200	670	2650	560	1850	135	2100	435
14	3000	680	3000	680	2700	630	2300	525	1600	125	1800	410
16	2600	680	2600	680	2400	630	2000	525	1400	120	1600	410
18	2300	670	2300	670	2100	620	1800	515	1250	105	1400	405
20	2050	670	2050	670	1900	620	1600	515	1100	105	1250	405

max. cutting depth

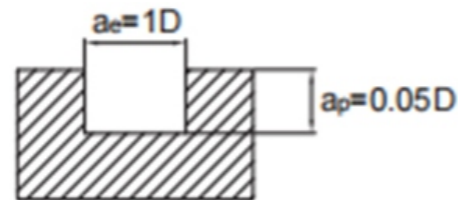
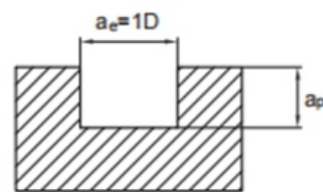
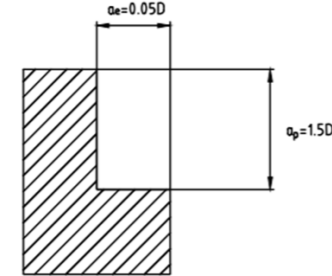
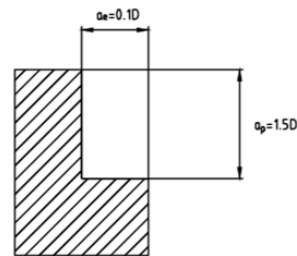

刀具直径 tool diameter	Ap
$\Phi 1 \leq D \leq \Phi 3$	0.15D
$\Phi 3 \leq D$	0.3D

- The above table shows the standard value of side milling. When milling slot, 50%~70% of rotating speed and 40%~60% of feed speed stated above are recommended as standard.
- Please select high-precision machine and tool holder.
- Please use air blow or cutting liquid with high mist retardant property.
- Down milling is recommended in the case of side milling.
- When the machine rigidity and workpiece fixture stability is low, vibration and abnormal noise may be generated. Please reduce the rotating speed and feed speed stated above correspondingly.
- Make overhang of tool as short as possible in conditions of non-interference.

OMPQ-2BH/G 2 flutes long shank/extra long shank ball head end mill

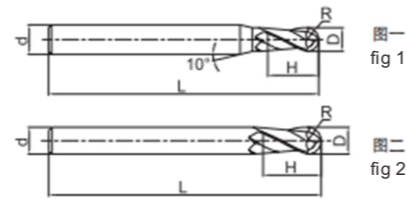

OMPQ-2B long shank and extra long shank series

helical angle $\angle 30^\circ$ diameter D tolerance 0.02 $R \pm 0.005$

part number	dimension (mm)					Number of flutes	Geometry	stock
	D	R	d	H	L			
OMPQ-2B-020R1.0SH	2	1	4	4	75	2	fig 1	●
OMPQ-2B-020R1.0H	2	1	6	4	75	2	fig 1	●
OMPQ-2B-025R1.25SH	2.5	1.25	4	5	75	2	fig 1	●
OMPQ-2B-025R1.25H	2.5	1.25	6	5	75	2	fig 1	●
OMPQ-2B-030R1.5SH	3	1.5	4	6	75	2	fig 1	●
OMPQ-2B-030R1.5H	3	1.5	6	6	75	2	fig 1	●
OMPQ-2B-035R1.75SH	3.5	1.75	4	8	75	2	fig 1	●
OMPQ-2B-035R1.75H	3.5	1.75	6	8	75	2	fig 1	●
OMPQ-2B-040R2.0SH	4	2	4	8	75	2	fig 2	●
OMPQ-2B-040R2.0H	4	2	6	8	75	2	fig 1	●
OMPQ-2B-050R2.5H	5	2.5	6	10	75	2	fig 1	●
OMPQ-2B-055R2.75H	5.5	2.75	6	12	75	2	fig 1	●
OMPQ-2B-060R3.0H	6	3	6	12	75	2	fig 2	●
OMPQ-2B-060R3.0G	6	3	6	12	100	2	fig 2	●
OMPQ-2B-070R3.5H	7	3.5	8	14	75	2	fig 1	●
OMPQ-2B-080R4.0H	8	4	8	16	75	2	fig 2	●
OMPQ-2B-080R4.0G	8	4	8	16	100	2	fig 2	●
OMPQ-2B-090R4.5H	9	4.5	10	18	100	2	fig 1	●
OMPQ-2B-100R5.0H	10	5	10	20	100	2	fig 2	●
OMPQ-2B-100R5.0G	10	5	10	20	150	2	fig 2	●
OMPQ-2B-120R6.0H	12	6	12	24	100	2	fig 2	●
OMPQ-2B-120R6.0G	12	6	12	24	150	2	fig 2	●
OMPQ-2B-140R7.0H	14	7	14	28	100	2	fig 2	●
OMPQ-2B-160R8.0H	16	8	16	32	150	2	fig 2	●
OMPQ-2B-200R10.0H	20	10	20	40	150	2	fig 2	●

● Stock available ▲ Make-to-order

Workpiece material (○ suitable, ◎ very suitable)

Carbon steel	Alloy steel	Pre-hardened steel, Hardened steel				Stainless steel	Cast iron, nodular cast iron	copper alloy	Aluminum alloy	titanium alloy	Heat resistant alloy
		~40HRC	~50HRC	~55HRC	~68HRC						
◎	◎	◎	○			○	◎				

OMPQ-2BH recommend cutting parameters

Workpiece material	Cast iron/nodular cast		Carbon steel, Alloy steel ~750N/mm2		Carbon steel, Alloy steel ~30HRC		Pre-hardened steel, hardened and tempered steel ~40HRC		Stainless steel		Pre-hardened steel, hardened and tempered steel ~50HRC	
	Diameter (mm)	Rotating speed (min ⁻¹)	Feedspeed (mm/min)	Rotating speed (min ⁻¹)	Feedspeed (mm/min)	Rotating speed (min ⁻¹)	Feedspeed (mm/min)	Rotating speed (min ⁻¹)	Feedspeed (mm/min)	Rotating speed (min ⁻¹)	Feedspeed (mm/min)	
R0.5	40000	800	40000	800	38000	700	32000	320	22300	200	25000	275
R1.0	24000	900	24000	900	19000	760	16000	400	11150	230	13000	275
R1.5	15500	950	15500	950	12750	760	10600	450	7400	290	8500	280
R2.0	11500	950	11500	950	9550	760	8000	550	5550	370	6500	370
R2.5	9500	1050	9500	1050	7650	800	6400	550	4450	370	5000	375
R3.0	8000	1050	8000	1050	6400	800	5300	580	3700	390	4200	390
R4.0	6000	1300	6000	1300	4800	950	4000	700	2750	455	3200	440
R5.0	4800	1200	4800	1200	3800	900	3200	650	2200	430	2500	440
R6.0	4000	1100	4000	1100	3200	840	2650	610	1850	430	2100	420
R8.0	3000	1050	3000	1050	2400	800	2000	600	1350	380	1600	375
R10.0	2400	950	2400	950	1900	680	1600	560	1100	370	1250	330

max. cutting depth

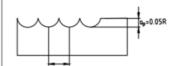
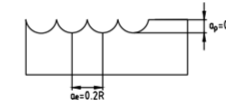

1. Please select high-precision machine and tool holder.
2. Please use air cooling or liquid cooling (Smoke-resistant cutting fluid).
3. When the machine rigidity and workpiece fixture stability is low, vibration and abnormal noise may be generated. Please reduce the rotating speed and feed rate stated above correspondingly.
4. Make overhang of tool as short as possible in conditions of non-interference.

OMPQ-4R 4 flutes straight shank corner radius end mill

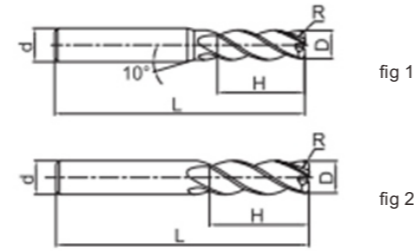

Wide range of applications, able to achieve a variety of forms of processing

helical angle $\angle 38^\circ$ diameter tolerance $D1\sim D6_{-0.02}^0 / D7\sim D20_{-0.025}^0$ radius R tolerance ± 0.02



part number	dimension (mm)					Number of flutes	Geometry	stock
	D	R	d	H	L			
OMPQ-4R-010R0.2S	1.0	0.2	4	3	50	4	fig 1	▲
OMPQ-4R-015R0.2S	1.5	0.2	4	4	50	4	fig 1	▲
OMPQ-4R-020R0.2S	2.0	0.2	4	6	50	4	fig 1	▲
OMPQ-4R-020R0.5S	2.0	0.5	4	6	50	4	fig 1	▲
OMPQ-4R-025R0.2S	2.5	0.2	4	8	50	4	fig 1	▲
OMPQ-4R-025R0.5S	2.5	0.5	4	8	50	4	fig 1	▲
OMPQ-4R-030R0.2S	3.0	0.2	4	8	50	4	fig 1	●
OMPQ-4R-030R0.5S	3.0	0.5	4	8	50	4	fig 1	●
OMPQ-4R-040R0.2S	4.0	0.2	4	10	50	4	fig 2	●
OMPQ-4R-040R0.3S	4.0	0.3	4	10	50	4	fig 2	●
OMPQ-4R-040R0.5	4.0	0.5	6	10	50	4	fig 2	●
OMPQ-4R-040R0.5S	4.0	0.5	4	10	50	4	fig 2	●
OMPQ-4R-050R0.2	5.0	0.2	6	13	50	4	fig 2	●
OMPQ-4R-050R0.5	5.0	0.5	6	13	50	4	fig 1	●
OMPQ-4R-050R1.0	5.0	1.0	6	13	50	4	fig 1	●
OMPQ-4R-060R0.2	6.0	0.2	6	16	50	4	fig 1	●
OMPQ-4R-060R0.3	6.0	0.3	6	16	50	4	fig 2	●
OMPQ-4R-060R0.5	6.0	0.5	6	16	50	4	fig 2	●
OMPQ-4R-060R1.0	6.0	1.0	6	16	50	4	fig 2	●
OMPQ-4R-080R0.3	8.0	0.3	8	20	60	4	fig 2	●
OMPQ-4R-080R0.5	8.0	0.5	8	20	60	4	fig 2	●
OMPQ-4R-080R1.0	8.0	1.0	8	20	60	4	fig 2	●
OMPQ-4R-100R0.3	10.0	0.3	10	25	75	4	fig 2	●
OMPQ-4R-100R0.5	10.0	0.5	10	25	75	4	fig 2	●
OMPQ-4R-100R1.0	10.0	1.0	10	25	75	4	fig 2	●
OMPQ-4R-100R2.0	10.0	2.0	10	25	75	4	fig 2	●
OMPQ-4R-100R3.0	10.0	3.0	10	25	75	4	fig 2	●
OMPQ-4R-120R0.3	12.0	0.3	12	30	75	4	fig 2	●
OMPQ-4R-120R0.5	12.0	0.5	12	30	75	4	fig 2	●
OMPQ-4R-120R1.0	12.0	1.0	12	30	75	4	fig 2	●
OMPQ-4R-120R2.0	12.0	2.0	12	30	75	4	fig 2	●
OMPQ-4R-120R3.0	12.0	3.0	12	30	75	4	fig 2	●

● Stock available ▲ Make-to-order

OMPQ-4RH/G 4 flutes long shank /extra long shank corner radius end mill



OMPQ-4R long shank/extra shank series.

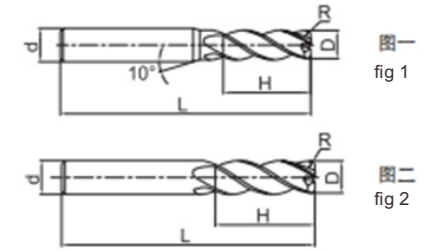

helical angle $\angle 38^\circ$ diameter tolerance $D1\sim D6_{-0.02}^0 / D7\sim D20_{-0.025}^0$ radius R tolerance ± 0.02



part number	dimension (mm)					Number of flutes	Geometry	stock
	D	R	d	H	L			
OMPQ-4R-040R0.2SH	4.0	0.2	4	10	75	4	fig 2	●
OMPQ-4R-040R0.2H	4.0	0.2	6	10	75	4	fig 2	●
OMPQ-4R-040R0.5SH	4.0	0.5	4	10	75	4	fig 2	●
OMPQ-4R-040R0.5H	4.0	0.5	6	10	75	4	fig 2	●
OMPQ-4R-060R0.2H	6.0	0.2	6	16	75	4	fig 2	●
OMPQ-4R-060R0.2G	6.0	0.2	6	16	100	4	fig 2	●
OMPQ-4R-060R0.5H	6.0	0.5	6	16	75	4	fig 2	●
OMPQ-4R-060R0.5G	6.0	0.5	6	16	100	4	fig 2	●
OMPQ-4R-060R1.0H	6.0	1.0	6	16	75	4	fig 2	●
OMPQ-4R-060R1.0G	6.0	1.0	6	16	100	4	fig 2	●
OMPQ-4R-080R0.2H	8.0	0.2	8	20	75	4	fig 2	●
OMPQ-4R-080R0.2G	8.0	0.2	8	20	100	4	fig 2	●
OMPQ-4R-080R0.5H	8.0	0.5	8	20	75	4	fig 2	●
OMPQ-4R-080R0.5G	8.0	0.5	8	20	100	4	fig 2	●
OMPQ-4R-080R1.0H	8.0	1.0	8	20	75	4	fig 2	●
OMPQ-4R-080R1.0G	8.0	1.0	8	20	100	4	fig 2	●
OMPQ-4R-100R0.2H	10.0	0.2	10	25	100	4	fig 2	●
OMPQ-4R-100R0.2G	10.0	0.2	10	25	150	4	fig 2	●
OMPQ-4R-100R0.5H	10.0	0.5	10	25	100	4	fig 2	●
OMPQ-4R-100R0.5G	10.0	0.5	10	25	150	4	fig 2	●
OMPQ-4R-100R1.0H	10.0	1.0	10	25	100	4	fig 2	●
OMPQ-4R-100R1.0G	10.0	1.0	10	25	150	4	fig 2	●
OMPQ-4R-100R2.0H	10.0	2.0	10	25	100	4	fig 2	●
OMPQ-4R-100R2.0G	10.0	2.0	10	25	150	4	fig 2	●
OMPQ-4R-120R0.2H	12.0	0.2	12	30	100	4	fig 2	●
OMPQ-4R-120R0.2G	12.0	0.2	12	30	150	4	fig 2	●
OMPQ-4R-120R0.5H	12.0	0.5	12	30	100	4	fig 2	●
OMPQ-4R-120R0.5G	12.0	0.5	12	30	150	4	fig 2	●
OMPQ-4R-120R1.0H	12.0	1.0	12	30	100	4	fig 2	●
OMPQ-4R-120R1.0G	12.0	1.0	12	30	150	4	fig 2	●
OMPQ-4R-120R2.0H	12.0	2.0	12	30	100	4	fig 2	●
OMPQ-4R-120R2.0G	12.0	2.0	12	30	150	4	fig 2	●

● Stock available ▲ Make-to-order

OMPX series, high performance and wide application range

OMPX is suitable for efficient cutting of workpiece hardness <HRC45

OMPX-4E

1 Fine grain size hard substrate with high resistance to bending and excellent heat impact resistance. Wear-resistant and heat-resistant coating improves tool life in difference processed materials. Unequal spiral Angle design plays a good effect of vibration control. It is widely used in difficult cutting material such as cast iron, die steel, stainless steel, Kovar-alloy, titanium alloy etc. to achieve high speed, high feed, and large cutting depth processing.

OMPX-4R

The design of curved rake face ensures the accuracy of R corner, in addition, continuously changed design of rake face angle improves the strength of the cutting edge and provides better tool life.

OMPX-2B

The combination of new coating and ultra fine super-hard substrate improves the heat and wear resistance. Curvilinear cutting edge enhances cutting edge strength, reduces cutting resistance, and improves wear resistance and chipping resistance. The special design of the tooth space angle improves the chip discharge performance.

Workpiece material (○suitable, ⊙very suitable)

Carbon steel	Alloy steel	Pre-hardened steel, Hardened steel				Stainless steel	Cast iron, nodular cast iron	copper alloy	Aluminum alloy	titanium alloy	Heat resistant alloy
		~40HRC	~50HRC	~55HRC	~68HRC						
⊙	⊙	⊙	○			○	⊙				

OMPQ-4R recommend cutting parameters

Workpiece material	Cast iron nodular cast		Carbon steel, Alloy steel ~750N/mm2		Carbon steel, Alloy steel ~30HRC		Pre-hardened steel, hardened and tempered steel ~40HRC		Stainless steel		Pre-hardened steel, hardened and tempered steel ~50HRC	
	Diameter (mm)	Rotating speed (min ⁻¹)	Feedspeed (mm/min)	Rotating speed (min ⁻¹)	Feedspeed (mm/min)	Rotating speed (min ⁻¹)	Feedspeed (mm/min)	Rotating speed (min ⁻¹)	Feedspeed (mm/min)	Rotating speed (min ⁻¹)	Feedspeed (mm/min)	Rotating speed (min ⁻¹)
3	14000	820	14000	820	13000	755	10600	630	7500	145	8500	490
4	10800	840	10800	840	10000	770	8000	640	5500	145	6500	500
5	8200	880	8200	880	7600	810	6400	670	4500	145	5000	530
6	7000	900	7000	900	6400	830	5300	690	3700	160	4200	540
8	5200	890	5200	890	4800	815	4000	680	2800	160	3200	550
10	4200	880	4200	880	3800	810	3200	670	2200	160	2500	520
12	3500	880	3500	880	3200	810	2650	670	1850	160	2100	520
16	2600	680	2600	680	2400	630	2000	525	1400	120	1600	490

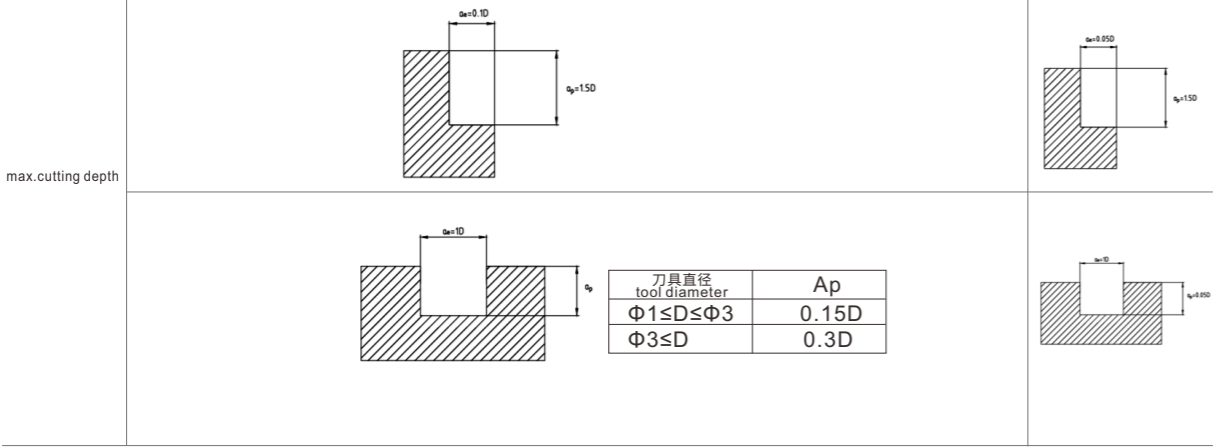

- The above table shows the standard value of side milling. When milling slot, 50%~70% of rotating speed and 40%~60% of feed speed stated above are recommended as standard.
- Please select high-precision machine and tool holder.
- Please use air cooling or liquid cooling (Smoke-resistant cutting fluid).
- Climb cutting is recommended in the case of side milling.
- When the machine rigidity and workpiece fixture stability is low, vibration and abnormal noise may be generated. Please reduce the rotating speed and feed rate correspondingly.
- Make overhang of tool as short as possible in conditions of non-interference.



OMPX-4E 4 flutes straight shank flat end mill

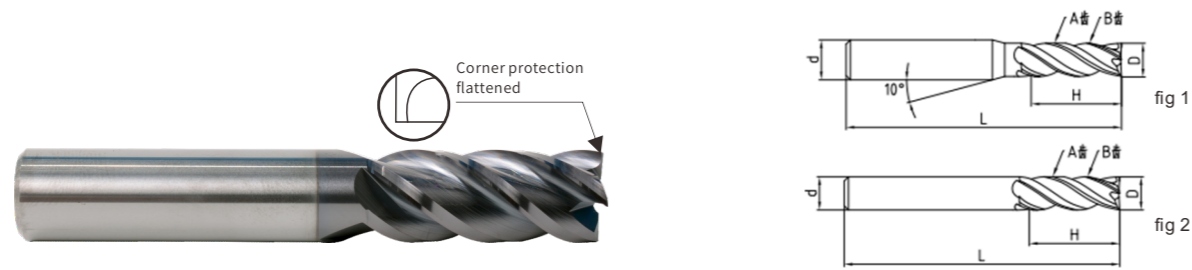

Most suitable for side milling and shallow groove processing. Wide applicability

helical angle $\angle 41^\circ$, helical angle $\angle 38^\circ$ diameter tolerance $D1\sim D6_{-0.02}^0 / D7\sim D20_{-0.025}^0$

part number	dimension (mm)				Number of flutes	Geometry	stock
	D	d	H	L			
OMPX-4E-010S	1	4	3	50	4	fig 1	●
OMPX-4E-015S	1.5	4	4	50	4	fig 1	●
OMPX-4E-020S	2	4	6	50	4	fig 1	●
OMPX-4E-025S	2.5	4	8	50	4	fig 1	●
OMPX-4E-030S	3.0	4	8	50	4	fig 1	●
OMPX-4E-025	2.5	6	8	50	4	fig 1	●
OMPX-4E-030	3.0	6	8	50	4	fig 1	●
OMPX-4E-035S	3.5	4	10	50	4	fig 1	●
OMPX-4E-040S	4.0	4	11	50	4	fig 2	●
OMPX-4E-035	3.5	6	10	50	4	fig 1	●
OMPX-4E-040	4.0	6	11	50	4	fig 1	●
OMPX-4E-045	4.5	6	11	50	4	fig 1	●
OMPX-4E-050	5.0	6	13	50	4	fig 1	●
OMPX-4E-055	5.5	6	16	50	4	fig 1	●
OMPX-4E-060	6.0	6	16	50	4	fig 2	●
OMPX-4E-070	7.0	8	20	60	4	fig 1	●
OMPX-4E-080	8.0	8	20	60	4	fig 2	●
OMPX-4E-090	9.0	10	22	75	4	fig 1	●
OMPX-4E-100	10.0	10	25	75	4	fig 2	●
OMPX-4E-110	11.0	12	26	75	4	fig 1	●
OMPX-4E-120	12.0	12	30	75	4	fig 2	●
OMPX-4E-140	14.0	14	32	75	4	fig 2	●
OMPX-4E-160	16.0	16	45	100	4	fig 2	●
OMPX-4E-180	18.0	18	45	100	4	ig 2	●
OMPX-4E-200	20.0	20	45	100	4	fig 2	●

● Stock available ▲ Make-to-order

Workpiece material (○suitable, ◎very suitable)

Carbon steel	Alloy steel	Pre-hardened steel, Hardened steel				Stainless steel	Cast iron, nodular cast iron	copper alloy	Aluminum alloy	titanium alloy	Heat resistant alloy
		~40HRC	~50HRC	~55HRC	~68HRC						
◎	◎	◎	◎		◎	◎			○	○	

OMPX-4EL 4 flutes long cutting edge flat end mill

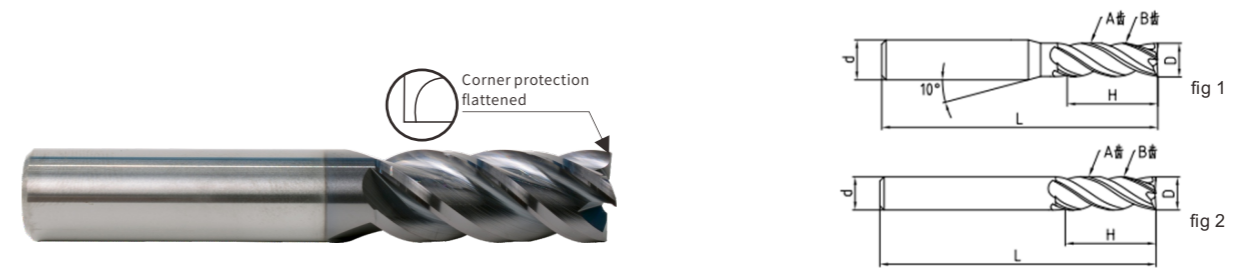

OMPX-4E Long cutting edge series

A helical angle $\angle 41^\circ / 40^\circ / 39^\circ$, B helical angle $\angle 38^\circ$ diameter tolerance $D1\sim D6_{-0.02}^0 / D7\sim D20_{-0.025}^0$

part number	dimension (mm)				Number of flutes	Geometry	stock
	D	d	H	L			
OMPX-4E-030L	3.0	6	12	75	4	fig 1	●
OMPX-4E-040L	4.0	6	15	75	4	fig 1	●
OMPX-4E-050L	5.0	6	20	75	4	fig 1	●
OMPX-4E-060L	6.0	6	20	75	4	fig 2	●
OMPX-4E-080L	8.0	8	25	100	4	fig 2	●
OMPX-4E-100L	10.0	10	30	100	4	fig 2	●
OMPX-4E-120L	12.0	12	35	100	4	fig 2	●
OMPX-4E-140L	14.0	14	40	100	4	fig 2	●
OMPX-4E-160L	16.0	16	50	150	4	fig 2	●
OMPX-4E-200L	20.0	20	55	150	4	fig 2	●

● Stock available ▲ Make-to-order

Workpiece material (○suitable, ◎very suitable)

Carbon steel	Alloy steel	Pre-hardened steel, Hardened steel				Stainless steel	Cast iron, nodular cast iron	copper alloy	Aluminum alloy	titanium alloy	Heat resistant alloy
		~40HRC	~50HRC	~55HRC	~68HRC						
◎	◎	◎	◎		◎	◎			○	○	

OMPX-4EH/G 4 flutes long shank /extra long shank flat end mill



Corner protection flattened

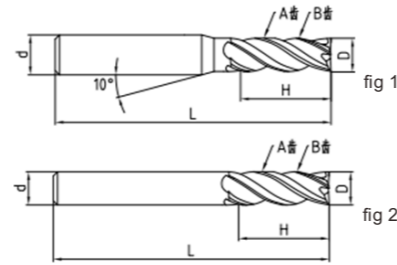

OMPX-4E long shank/extra shank series.

A helical angle $\angle 41^\circ$, B helical angle $\angle 38^\circ$ diameter tolerance $D1\sim D6_{-0.02}^0 / D7\sim D20_{-0.025}^0$

part number	dimension (mm)				Number of flutes	Geometry	stock
	D	d	H	L			
OMPX-4E-030SH	3.0	4	8	75	4	fig 1	●
OMPX-4E-030H	3.0	6	8	75	4	fig 1	●
OMPX-4E-040SH	4.0	4	11	75	4	fig 2	●
OMPX-4E-040H	4.0	6	11	75	4	fig 1	●
OMPX-4E-050H	5.0	6	13	75	4	fig 1	●
OMPX-4E-060H	6.0	6	16	75	4	fig 2	●
OMPX-4E-060G	6.0	6	16	100	4	fig 2	●
OMPX-4E-080H	8.0	8	20	75	4	fig 2	●
OMPX-4E-080G	8.0	8	20	100	4	fig 2	●
OMPX-4E-100H	10.0	10	25	100	4	fig 2	●
OMPX-4E-100G	10.0	10	25	150	4	fig 2	●
OMPX-4E-120H	12.0	12	30	100	4	fig 2	●
OMPX-4E-120G	12.0	12	30	150	4	fig 2	●

● Stock available ▲ Make-to-order

Workpiece material (○suitable、◎very suitable)

Carbon steel	Alloy steel	Pre-hardened steel, Hardened steel				Stainless steel	Cast iron, nodular cast iron	copper alloy	Aluminum alloy	titanium alloy	Heat resistant alloy
		~40HRC	~50HRC	~55HRC	~68HRC						
◎	◎	◎	◎			◎	◎			○	○

OMPX-4EH/G 4 flutes long shank /extra long shank flat end mill

OMPX-4E/4EL/4EH/4EG recommend cutting parameters(Normal cutting)

Workpiece material	Cast iron, carbon steel, Alloy Steel ~30HRC		Stainless steel		Pre-hardened steel,hardened and tempered steel ~40HRC		Pre-hardened steel,hardened and tempered steel ~50HRC		Quenched steel 55HRC	
	Rotating speed (min ⁻¹)	Feedspeed (mm/min)	Rotating speed (min ⁻¹)	Feedspeed (mm/min)	Rotating speed (min ⁻¹)	Feedspeed (mm/min)	Rotating speed (min ⁻¹)	Feedspeed (mm/min)	Rotating speed (min ⁻¹)	Feedspeed (mm/min)
1	20000	300	20000	108	20000	240	20000	180	20000	135
2	15000	480	11500	120	15000	420	13000	270	11140	195
3	14000	815	7500	145	10600	630	8500	495	7430	360
4	10800	840	5500	150	8000	645	6500	505	5570	370
5	8200	875	4500	150	6400	675	5000	530	4460	390
6	7000	900	3700	165	5300	690	4200	540	3710	390
8	5200	890	2800	165	4000	680	3200	555	2785	405
10	4200	875	2200	165	3200	675	2500	525	2230	375
12	3500	875	1850	165	2650	675	2100	525	1855	375
14	3000	815	1600	150	2300	630	1800	495	1590	360
16	2600	815	1400	145	2000	630	1600	495	1390	360
18	2300	805	1250	125	1800	620	1400	485	1240	350
20	2050	805	1100	125	1600	620	1250	485	1115	350

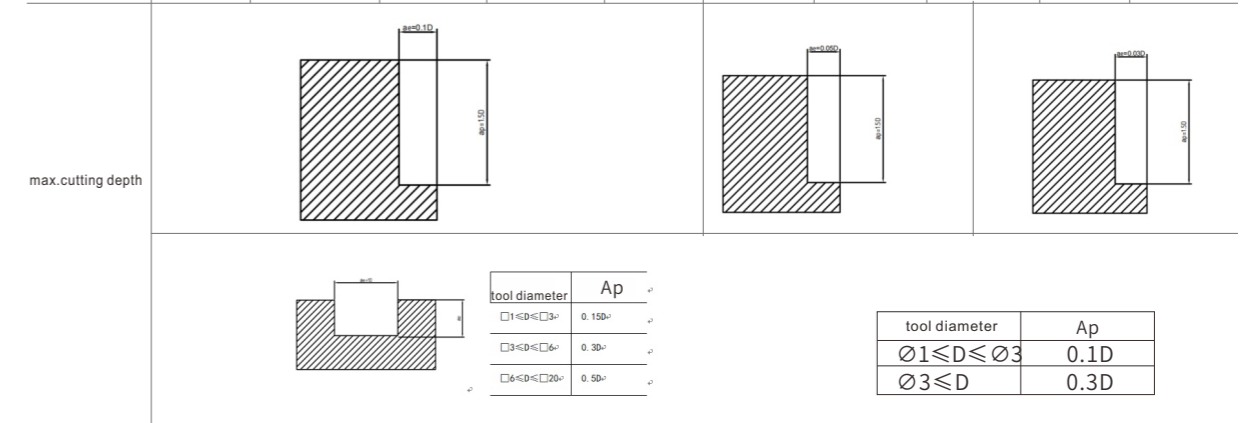

- The above table shows the standard value of side milling. When milling slot, 50%~70% of rotating speed and 40%~60% of feed speed stated above are recommended as standard.
- Please select high-precision machine and tool holder.
- Please use air cooling or liquid cooling (Smoke-resistant cutting fluid).
- Climb cutting is recommended in the case of side milling.
- When the machine rigidity and workpiece fixture stability is low, vibration and abnormal noise may be generated. Please reduce the rotating speed and feed rate stated above correspondingly.
- Make overhang of tool as short as possible in conditions of non-interference.

OMPX-4EH/G 4 flutes long shank /extra long shank flat end mill

OMPX-4E/4EL/4EH/4EG recommend cutting parameters(high speed cutting)

Workpiece material	Cast iron, carbon steel, Alloy Steel 30HRC		Stainless steel		Pre-hardened steel, hardened and tempered steel 40HRC		Pre-hardened steel, hardened and tempered steel 50HRC		Quenched steel 55HRC	
	Diameter (mm)	Rotating speed (min ⁻¹)	Feedspeed (mm/min)	Rotating speed (min ⁻¹)	Feedspeed (mm/min)	Rotating speed (min ⁻¹)	Feedspeed (mm/min)	Rotating speed (min ⁻¹)	Feedspeed (mm/min)	Rotating speed (min ⁻¹)
6	15915	1705	13260	1420	10600	1135	7960	850	5300	570
8	11935	1700	9950	1400	7960	1130	5970	850	3980	570
10	9550	1660	7960	1380	6370	1110	4775	830	3180	550
12	7960	1660	6630	1380	5300	1110	3980	830	2650	550
14	6820	1545	5685	1290	4550	1030	3410	900	2275	515
16	5970	1545	4975	1290	3980	1030	2985	900	1990	515
18	5305	1545	4420	1290	3540	1030	2650	900	1770	515
20	4775	1545	3980	1290	3180	1030	2390	900	1590	515

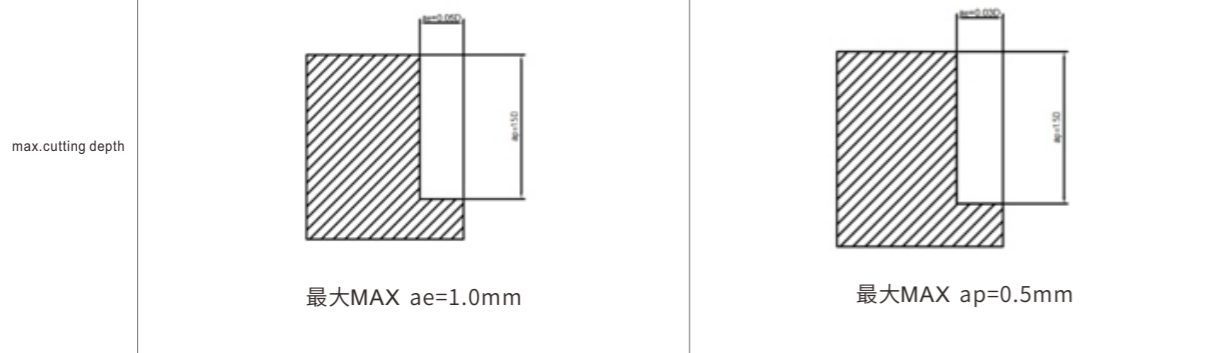

1. Please select high-precision machine and tool holder.
2. Please use air cooling or MQL (minimum oil mist cooling)
3. climb milling is recommended in the case of side milling.
4. When the machine rigidity and workpiece fixture stability is low, vibration and abnormal noise may be generated. Please reduce the rotating speed and feed rate stated above correspondingly.
5. Make overhang of tool as short as possible in conditions of non-interference.

OMPX-4R 4 flutes straight shank corner radius end mill

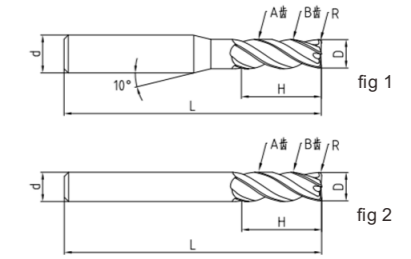

wide range of applications, able to achieve various forms of processing

A helical angle $\angle 41^\circ$, B helical angle $\angle 38^\circ$ diameter tolerance $D1\sim D6_{-0.02}^0 / D7\sim D20_{-0.025}^0$ $R \pm 0.01$



part number	dimension (mm)					Number of flutes	Geometry	stock
	D	R	H	L	d			
OMPX-4R-010R0.2S	1.0	0.2	3	50	4	4	fig 1	▲
OMPX-4R-015R0.2S	1.5	0.2	4	50	4	4	fig 1	▲
OMPX-4R-020R0.2S	2.0	0.2	6	50	4	4	fig 1	▲
OMPX-4R-020R0.2	2.0	0.2	6	50	6	4	fig 1	▲
OMPX-4R-020R0.5S	2.0	0.5	6	50	4	4	fig 1	▲
OMPX-4R-020R0.5	2.0	0.5	6	50	6	4	fig 1	▲
OMPX-4R-025R0.2S	2.5	0.2	8	50	4	4	fig 1	▲
OMPX-4R-025R0.2	2.5	0.5	8	50	6	4	fig 1	▲
OMPX-4R-025R0.5S	2.5	0.5	8	50	4	4	fig 1	▲
OMPX-4R-025R0.5	2.5	0.5	8	50	6	4	fig 1	▲
OMPX-4R-030R0.2S	3.0	0.2	8	50	4	4	fig 1	●
OMPX-4R-030R0.2	3.0	0.2	8	50	6	4	fig 1	●
OMPX-4R-030R0.5S	3.0	0.5	8	50	4	4	fig 1	●
OMPX-4R-030R0.5	3.0	0.5	8	50	6	4	fig 1	●
OMPX-4R-040R0.2S	4.0	0.2	11	50	4	4	fig 2	●
OMPX-4R-040R0.2	4.0	0.2	11	50	6	4	fig 1	●
OMPX-4R-040R0.3S	4.0	0.3	11	50	4	4	fig 2	●
OMPX-4R-040R0.3	4.0	0.3	11	50	6	4	fig 1	●
OMPX-4R-040R0.5S	4.0	0.5	11	50	4	4	fig 2	●
OMPX-4R-040R0.5	4.0	0.5	11	50	6	4	fig 1	●
OMPX-4R-050R0.2	5.0	0.2	13	50	6	4	fig 1	●
OMPX-4R-050R0.3	5.0	0.3	13	50	6	4	fig 1	●
OMPX-4R-050R0.5	5.0	0.5	13	50	6	4	fig 1	●
OMPX-4R-050R1.0	5.0	1.0	13	50	6	4	fig 1	●
OMPX-4R-060R0.2	6.0	0.2	16	50	6	4	fig 2	●
OMPX-4R-060R0.3	6.0	0.3	16	50	6	4	fig 2	●
OMPX-4R-060R0.5	6.0	0.5	16	50	6	4	fig 2	●
OMPX-4R-060R1.0	6.0	1.0	16	50	6	4	fig 2	●
OMPX-4R-080R0.2	8.0	0.2	20	60	8	4	fig 2	●
OMPX-4R-080R0.3	8.0	0.3	20	60	8	4	fig 2	●
OMPX-4R-080R0.5	8.0	0.5	20	60	8	4	fig 2	●
OMPX-4R-080R1.0	8.0	1.0	20	60	8	4	fig 2	●
OMPX-4R-100R0.2	10.0	0.2	25	75	10	4	fig 2	●
OMPX-4R-100R0.3	10.0	0.3	25	75	10	4	fig 2	●

●Stock available ▲Make-to-order

OMPX-4RH/G 4 flutes long shank/extra long corner radius end mill

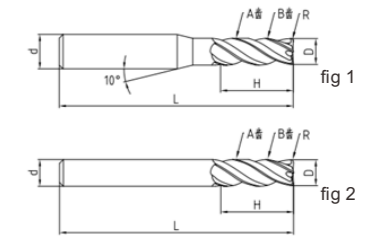

long shank /Extra long shank series

A helical angle $\angle 41^\circ$, B helical angle $\angle 38^\circ$ diameter tolerance $D1\sim D6_{-0.02}^0 / D7\sim D20_{-0.025}^0$ $R \pm 0.01$



part number	dimension (mm)					Number of flutes	Geometry	stock
	D	R	H	L	d			
OMPX-4R-100R0.5	10.0	0.5	25	75	10	4	fig 2	●
OMPX-4R-100R1.0	10.0	1.0	25	75	10	4	fig 2	●
OMPX-4R-100R2.0	10.0	2.0	25	75	10	4	fig 2	●
OMPX-4R-100R3.0	10.0	3.0	25	75	10	4	fig 2	●
OMPX-4R-120R0.2	12.0	0.2	30	75	12	4	fig 2	●
OMPX-4R-120R0.3	12.0	0.3	30	75	12	4	fig 2	●
OMPX-4R-120R0.5	12.0	0.5	30	75	12	4	fig 2	●
OMPX-4R-120R1.0	12.0	1.0	30	75	12	4	fig 2	●
OMPX-4R-120R2.0	12.0	2.0	30	75	12	4	fig 2	●
OMPX-4R-120R3.0	12.0	3.0	30	75	12	4	fig 2	●

●Stock available▲Make-to-order

Workpiece material (○suitable, ◎very suitable)

Carbon steel	Alloy steel	Pre-hardened steel, Hardened steel				Stainless steel	Cast iron, nodular cast iron	copper alloy	Aluminum alloy	titanium alloy	Heat resistant alloy
		~40HRC	~50HRC	~55HRC	~68HRC						
◎	◎	◎	◎			◎	◎		○	○	

part number	dimension (mm)					Number of flutes	Geometry	stock
	D	R	H	L	d			
OMPX-4R-040R0.2SH	4.0	0.2	10	75	4	4	fig 2	▲
OMPX-4R-040R0.2H	4.0	0.2	10	75	6	4	fig 1	▲
OMPX-4R-040R0.5SH	4.0	0.5	10	75	4	4	fig 2	▲
OMPX-4R-040R0.5H	4.0	0.5	10	75	6	4	fig 1	▲
OMPX-4R-060R0.2H	6.0	0.2	16	75	6	4	fig 2	▲
OMPX-4R-060R0.2G	6.0	0.2	16	100	6	4	fig 2	▲
OMPX-4R-060R0.5H	6.0	0.5	16	75	6	4	fig 2	▲
OMPX-4R-060R0.5G	6.0	0.5	16	100	6	4	fig 2	▲
OMPX-4R-060R1.0H	6.0	1.0	16	75	6	4	fig 2	▲
OMPX-4R-060R1.0G	6.0	1.0	16	100	6	4	fig 2	▲
OMPX-4R-080R0.2H	8.0	0.2	20	75	8	4	fig 2	▲
OMPX-4R-080R0.2G	8.0	0.2	20	100	8	4	fig 2	▲
OMPX-4R-080R0.5H	8.0	0.5	20	75	8	4	fig 2	▲
OMPX-4R-080R0.5G	8.0	0.5	20	100	8	4	fig 2	▲
OMPX-4R-080R1.0H	8.0	1.0	20	75	8	4	fig 2	▲
OMPX-4R-080R1.0G	8.0	1.0	20	100	8	4	fig 2	▲
OMPX-4R-100R0.2H	10.0	0.2	25	100	10	4	fig 2	▲
OMPX-4R-100R0.2G	10.0	0.2	25	150	10	4	fig 2	▲
OMPX-4R-100R0.5H	10.0	0.5	25	100	10	4	fig 2	▲
OMPX-4R-100R0.5G	10.0	0.5	25	150	10	4	fig 2	▲
OMPX-4R-100R1.0H	10.0	1.0	25	100	10	4	fig 2	▲
OMPX-4R-100R1.0G	10.0	1.0	25	150	10	4	fig 2	▲
OMPX-4R-100R2.0H	10.0	2.0	25	100	10	4	fig 2	▲
OMPX-4R-100R2.0G	10.0	2.0	25	150	10	4	fig 2	▲
OMPX-4R-120R0.2H	12.0	0.2	30	100	12	4	fig 2	▲
OMPX-4R-120R0.2G	12.0	0.2	30	150	12	4	fig 2	▲
OMPX-4R-120R0.5H	12.0	0.5	30	100	12	4	fig 2	▲
OMPX-4R-120R0.5G	12.0	0.5	30	150	12	4	fig 2	▲
OMPX-4R-120R1.0H	12.0	1.0	30	100	12	4	fig 2	▲
OMPX-4R-120R1.0G	12.0	1.0	30	150	12	4	fig 2	▲
OMPX-4R-120R2.0H	12.0	2.0	30	100	12	4	fig 2	▲
OMPX-4R-120R2.0G	12.0	2.0	30	150	12	4	fig 2	▲

●Stock available▲Make-to-order

Workpiece material (○suitable, ◎very suitable)

Carbon steel	Alloy steel	Pre-hardened steel, Hardened steel				Stainless steel	Cast iron, nodular cast iron	copper alloy	Aluminum alloy	titanium alloy	Heat resistant alloy
		~40HRC	~50HRC	~55HRC	~68HRC						
◎	◎	◎	◎			◎	◎		○	○	

OMPX-4RH/G 4 flutes long shank/extra long corner radius end mill

OMPX-4R/4RH/4RG recommend cutting parameters(normal cutting)

Workpiece material	Cast iron, carbon steel, Alloy Steel 30HRC		Stainless steel		Pre-hardened steel, hardened and tempered steel 40HRC		Pre-hardened steel, hardened and tempered steel ~50HRC		Quenched steel 55HRC	
	Diameter (mm)	Rotating speed (min ⁻¹)	Feedspeed (mm/min)	Rotating speed (min ⁻¹)	Feedspeed (mm/min)	Rotating speed (min ⁻¹)	Feedspeed (mm/min)	Rotating speed (min ⁻¹)	Feedspeed (mm/min)	Rotating speed (min ⁻¹)
3	14000	985	7500	175	10600	755	8500	590	7430	435
4	10800	1010	5500	175	8000	770	6500	600	5570	445
5	8200	1055	4500	175	6400	805	5000	640	4460	470
6	7000	1080	3700	195	5300	830	4200	650	3710	470
8	5200	1070	2800	195	4000	815	3200	660	2785	485
10	4200	1055	2200	195	3200	805	2500	625	2230	450
12	3500	1055	1850	195	2650	805	2100	625	1855	450
16	2600	985	1400	175	2000	755	1600	590	1390	435

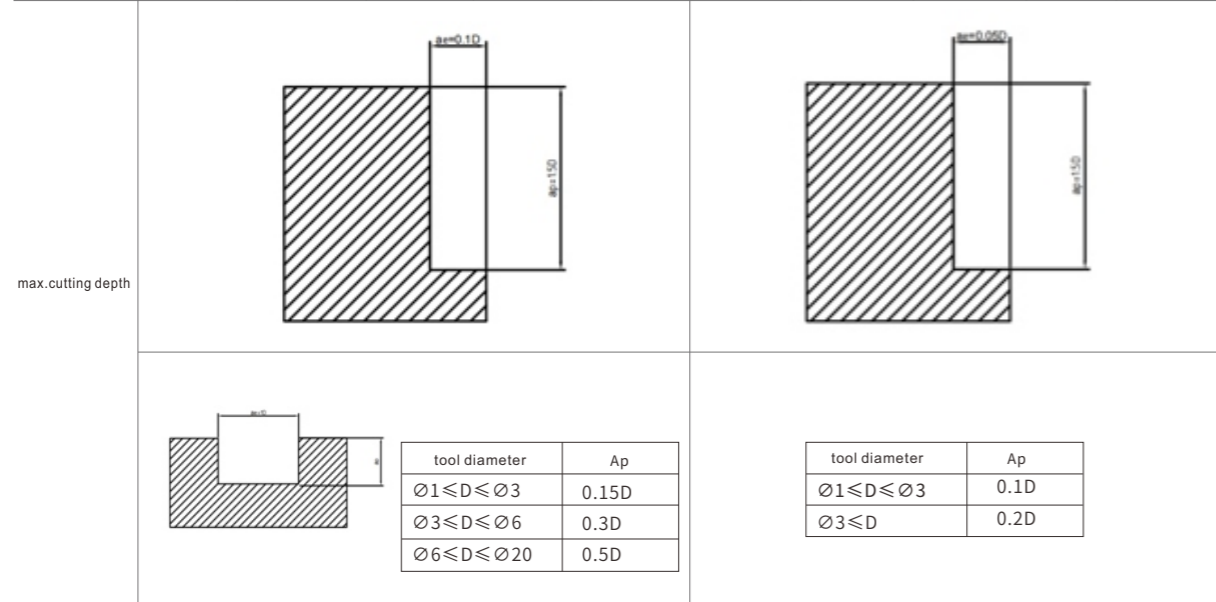

- The above table shows the standard value of side milling. When milling slot, 50%~70% of rotating speed and 40%~60% of feed speed stated above are recommended as standard.
- Please select high-precision machine and tool holder.
- Please use air cooling or liquid cooling (Smoke-resistant cutting fluid).
- Climb milling is recommended in the case of side milling.
- When the machine rigidity and workpiece fixture stability is low, vibration and abnormal noise may be generated. Please reduce the rotating speed and feed rate stated above correspondingly.
- Make overhang of tool as short as possible in conditions of non-interference.

OMPX-2B 2 flutes straight shank ball head end mill



wide range of applications, able to achieve various forms of processing

helical angle $\angle 30^\circ$ diameter tolerance $D1 \sim D20 \begin{matrix} 0 \\ -0.02 \end{matrix}$ $R \pm 0.005$

part number	dimension (mm)					Number of flutes	Geometry	stock
	D	R	H	L	d			
OMPX-2B-010R0.5S	1.0	0.5	2	50	4	2	fig 1	▲
OMPX-2B-010R0.5	1.0	0.5	2	50	6	2	fig 1	▲
OMPX-2B-015R0.75S	1.5	0.75	3	50	4	2	fig 1	▲
OMPX-2B-015R0.75	1.5	0.75	3	50	6	2	fig 1	▲
OMPX-2B-020R1.0F	2.0	1.0	4	50	3	2	fig 1	●
OMPX-2B-020R1.0S	2.0	1.0	4	50	4	2	fig 1	●
OMPX-2B-020R1.0	2.0	1.0	4	50	6	2	fig 1	●
OMPX-2B-025R1.25F	2.5	1.25	5	50	3	2	fig 1	●
OMPX-2B-025R1.25S	2.5	1.25	5	50	4	2	fig 1	●
OMPX-2B-025R1.25	2.5	1.25	5	50	6	2	fig 1	●
OMPX-2B-030R1.5F	3.0	1.5	6	50	3	2	fig 2	●
OMPX-2B-030R1.5S	3.0	1.5	6	50	4	2	fig 1	●
OMPX-2B-030R1.5	3.0	1.5	6	50	6	2	fig 1	●
OMPX-2B-035R1.75S	3.5	1.75	8	50	4	2	fig 1	●
OMPX-2B-035R1.75	3.5	1.75	8	50	6	2	fig 1	●
OMPX-2B-040R2.0S	4.0	2.0	8	50	4	2	fig 2	●
OMPX-2B-040R2.0	4.0	2.0	8	50	6	2	fig 1	●
OMPX-2B-050R2.5	5.0	2.5	10	50	6	2	fig 1	●
OMPX-2B-055R2.75	5.5	2.75	12	50	6	2	fig 1	●
OMPX-2B-060R3.0	6.0	3.0	12	50	6	2	fig 2	●
OMPX-2B-070R3.5	7.0	3.5	14	60	8	2	fig 1	●
OMPX-2B-080R4.0	8.0	4.0	16	60	8	2	fig 2	●
OMPX-2B-090R4.5	9.0	4.5	18	75	10	2	fig 1	●
OMPX-2B-100R5.0	10.0	5.0	20	75	10	2	fig 2	●
OMPX-2B-120R6.0	12.0	6.0	24	75	12	2	fig 2	●
OMPX-2B-140R7.0	14.0	7.0	28	75	14	2	fig 2	●
OMPX-2B-160R8.0	16.0	8.0	32	100	16	2	fig 2	●
OMPX-2B-200R10.0	20.0	10.0	40	100	20	2	fig 2	●

Workpiece material (○suitable, ●very suitable)

Carbon steel	Alloy steel	Pre-hardened steel, Hardened steel				Stainless steel	Cast iron, nodular cast iron	copper alloy	Aluminum alloy	titanium alloy	Heat resistant alloy
		~40HRC	~50HRC	~55HRC	~68HRC						
○	○	○	○			○	○		○	○	

OMPX-2BH/G 2 flutes long shank/extra long shank ball head end mill

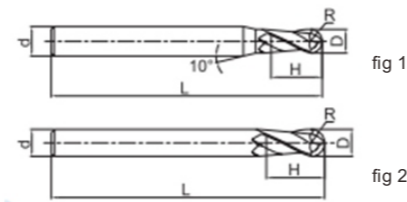

OMPX-2B Long shank/Extra long shank series

helical angle $\angle 30^\circ$ diameter tolerance $D1 \sim D20 \begin{smallmatrix} 0 \\ -0.02 \end{smallmatrix}$ $R \pm 0.005$



part number	dimension (mm)					Number of flutes	Geometry	stock
	D	R	H	L	d			
OMPX-2B-020R1.0SH	2.0	1.0	4	75	4	2	fig 1	▲
OMPX-2B-020R1.0H	2.0	1.0	4	75	6	2	fig 1	▲
OMPX-2B-025R1.25SH	2.5	1.25	5	75	4	2	fig 1	▲
OMPX-2B-025R1.25H	2.5	1.25	5	75	6	2	fig 1	▲
OMPX-2B-030R1.5SH	3.0	1.5	6	75	4	2	fig 1	▲
OMPX-2B-030R1.5H	3.0	1.5	6	75	6	2	fig 1	▲
OMPX-2B-035R1.75SH	3.5	1.75	8	75	4	2	fig 1	▲
OMPX-2B-035R1.75H	3.5	1.75	8	75	6	2	fig 1	▲
OMPX-2B-040R2.0SH	4.0	2.0	8	75	4	2	fig 2	▲
OMPX-2B-040R2.0H	4.0	2.0	8	75	6	2	fig 1	▲
OMPX-2B-050R2.5H	5.0	2.5	10	75	6	2	fig 1	▲
OMPX-2B-055R2.75H	5.5	2.75	12	75	6	2	fig 1	▲
OMPX-2B-060R3.0H	6.0	3.0	12	75	6	2	fig 2	▲
OMPX-2B-060R3.0G	6.0	3.0	12	100	6	2	fig 2	▲
OMPX-2B-070R3.5H	7.0	3.5	14	75	8	2	fig 1	▲
OMPX-2B-080R4.0H	8.0	4.0	16	75	8	2	fig 2	▲
OMPX-2B-080R4.0G	8.0	4.0	16	100	8	2	fig 2	▲
OMPX-2B-090R4.5H	9.0	4.5	18	100	10	2	fig 1	▲
OMPX-2B-100R5.0H	10.0	5.0	20	100	10	2	fig 2	▲
OMPX-2B-100R5.0G	10.0	5.0	20	150	10	2	fig 2	▲
OMPX-2B-120R6.0H	12.0	6.0	24	100	12	2	fig 2	▲
OMPX-2B-120R6.0G	12.0	6.0	24	150	12	2	fig 2	▲
OMPX-2B-140R7.0H	14.0	7.0	28	100	14	2	fig 2	▲
OMPX-2B-160R8.0H	16.0	8.0	32	150	16	2	fig 2	▲
OMPX-2B-200R10.0H	20.0	10.0	32	150	20	2	fig 2	▲

● Stock available ▲ Make-to-order

OMPX-2B/2BG/2BH recommend cutting parameters (normal cutting)

Workpiece material	Cast iron, carbon steel, Alloy Steel 30HRC		Stainless steel		Pre-hardened steel, hardened and tempered steel 40HRC		Pre-hardened steel, hardened and tempered steel ~50HRC		Quenched steel 55HRC	
	Diameter (mm)	Rotating speed (min-1)	Feedspeed (mm/min)	Rotating speed (min-1)	Feedspeed (mm/min)	Rotating speed (min-1)	Feedspeed (mm/min)	Rotating speed (min-1)	Feedspeed (mm/min)	Rotating speed (min-1)
R0.5	40000	960	22300	240	32000	385	25000	330	22280	295
R1.0	24000	1080	11150	275	16000	480	13000	330	11140	295
R1.5	15500	1150	7400	350	10600	545	8500	335	7430	295
R2.0	11500	1150	5550	445	8000	665	6500	450	5570	385
R2.5	9500	1270	4450	445	6400	665	5000	455	4455	405
R3.0	8000	1270	3700	470	5300	700	4200	470	3715	420
R4.0	6000	1575	2750	550	4000	850	3200	535	2785	465
R5.0	4800	1455	2200	520	3200	785	2500	535	2230	465
R6.0	4000	1330	1850	520	2650	740	2100	505	1855	450
R8.0	3000	1270	1350	455	2000	725	1600	455	1395	395
R10.0	2400	1150	1100	445	1600	675	1250	400	1115	360

- 1 Please select high-precision machine and tool holder.
- 2 Please use air cooling or MQL (minimum oil mist cooling)
- 3 When the machine rigidity and workpiece fixture stability is low, vibration and abnormal noise may be generated.
- 4 Please reduce the rotating speed and feed rate stated above correspondingly.
Make overhang of tool as short as possible in conditions of non-interferen

Workpiece material (○suitable, ◎very suitable)

Carbon steel	Alloy steel	Pre-hardened steel, Hardened steel				Stainless steel	Cast iron, nodular cast iron	copper alloy	Aluminum alloy	titanium alloy	Heat resistant alloy
		~40HRC	~50HRC	~55HRC	~68HRC						
◎	◎	◎	◎			○	◎			○	○

OMH series for quenched steel

Product features and application range

The series are suitable for semi-finishing and finishing of steel <HRC55 and quenched steel;

1. High rigidity tool structure design, effectively reduces the vibration in the process of tool machining;
2. High strength, high toughness substrate with new high hard special coating, effectively prolongs the tool life, also gives better workpiece surface quality.

OMPX-2B/2BH recommend cutting parameters(high speed cutting)

Workpiece material	Cast iron, carbon steel, Alloy Steel 30HRC		Stainless steel		Pre-hardened steel,hardened and tempered steel 40HRC		Pre-hardened steel,hardened and tempered steel ~50HRC		Quenched steel 55HRC	
	Diameter (mm)	Rotating speed (min-1)	Feedspeed (mm/min)	Rotating speed (min-1)	Feedspeed (mm/min)	Rotating speed (min-1)	Feedspeed (mm/min)	Rotating speed (min-1)	Feedspeed (mm/min)	Rotating speed (min-1)
R3.0	15000	4800	11500	2750	9500	2250	7960	1885	6370	1510
R4.0	11500	3650	8950	2100	7150	1700	5970	1420	4775	1135
R5.0	9500	3000	7150	1700	5700	1350	4775	1130	3820	905
R6.0	7950	2500	5950	1400	4750	1100	3980	920	3180	735
R8.0	5950	1900	4450	1050	3550	850	2985	760	2390	610
R10.0	4750	1500	3550	850	2850	680	2390	570	1910	455

max. cutting depth

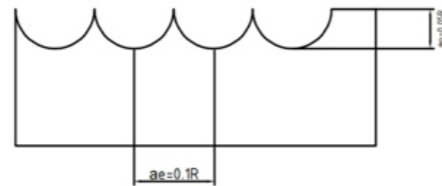

- 1 Please select high-precision machine and tool holder.
 - 2 Please use air cooling or MQL (minimum oil mist cooling)
 - 3 When the machine rigidity and workpiece fixture stability is low, vibration and abnormal noise may be generated.
 - 4 Please reduce the rotating speed and feed rate stated above correspondingly.
- Make overhang of tool as short as possible in conditions of non-interferen



OMH-4E 4 flutes straight flat head end mill

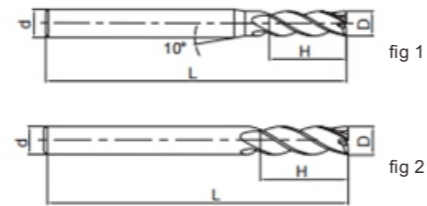
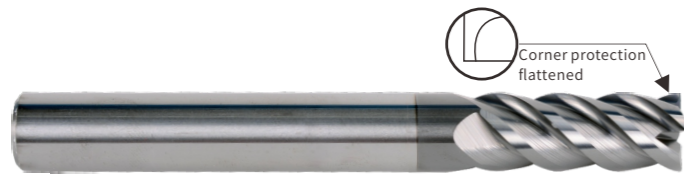

Suitable for side milling and shallow slot milling.
Most suitable for high speed milling and dry milling.

helical angle $\angle 45^\circ$ diameter tolerance $D1 \sim D6_{-0.02}^0 / D6 \sim D14_{-0.025}^0 / D15 \sim D20_{-0.03}^0$



part number	dimension (mm)				Number of flutes	Geometry	stock
	D	d	H	L			
OMH-4E-010F	1.0	3	3	50	4	fig 1	●
OMH-4E-010S	1.0	4	3	50	4	fig 1	●
OMH-4E-010	1.0	6	3	50	4	fig 1	●
OMH-4E-015F	1.5	3	4	50	4	fig 1	●
OMH-4E-015S	1.5	4	4	50	4	fig 1	●
OMH-4E-015	1.5	6	4	50	4	fig 1	●
OMH-4E-020F	2.0	3	6	50	4	fig 1	●
OMH-4E-020S	2.0	4	6	50	4	fig 1	●
OMH-4E-020	2.0	6	6	50	4	fig 1	●
OMH-4E-025F	2.5	3	8	50	4	fig1	●
OMH-4E-025S	2.5	4	8	50	4	fig 1	●
OMH-4E-025	2.5	6	8	50	4	fig 1	●
OMH-4E-030F	3.0	3	8	50	4	fig 2	●
OMH-4E-030S	3.0	4	8	50	4	fig 1	●
OMH-4E-030	3.0	6	8	50	4	fig 1	●
OMH-4E-035S	3.5	4	10	50	4	fig 1	●
OMH-4E-040S	4.0	4	11	50	4	fig 2	●
OMH-4E-035	3.5	6	10	50	4	fig 1	●
OMH-4E-040	4.0	6	11	50	4	fig1	●
OMH-4E-045	4.5	6	11	50	4	fig 1	●

● Stock available ▲ Make-to-order

part number	dimension (mm)				Number of flutes	Geometry	stock
	D	d	H	L			
OMH-4E-050	5.0	6	13	50	4	fig 1	●
OMH-4E-055	5.5	6	16	50	4	fig 1	●
OMH-4E-060	6.0	6	16	50	4	fig 2	●
OMH-4E-070	7.0	8	20	60	4	fig 1	●
OMH-4E-080	8.0	8	20	60	4	fig 2	●
OMH-4E-090	9.0	10	22	75	4	fig 1	●
OMH-4E-100	10.0	10	25	75	4	fig 2	●
OMH-4E-110	11.0	12	26	75	4	fig 1	●
OMH-4E-120	12.0	12	30	75	4	fig 2	●
OMH-4E-140	14.0	14	32	75	4	fig2	●
OMH-4E-160	16.0	16	45	100	4	fig 2	●
OMH-4E-180	18.0	18	45	100	4	fig2	●
OMH-4E-200	20.0	20	45	100	4	fig 2	●

● Stock available ▲ Make-to-order

Workpiece material (○suitable, ◎very suitable)

Carbon steel	Alloy steel	Pre-hardened steel, Hardened steel				Stainless steel	Cast iron, nodular cast iron	copper alloy	Aluminum alloy	titanium alloy	Heat resistant alloy
		~40HRC	~50HRC	~55HRC	~68HRC						
○	○	◎	◎	◎		○	○				

OMH-4EL 4 flute long shank flat end mill

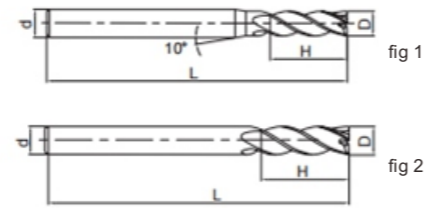
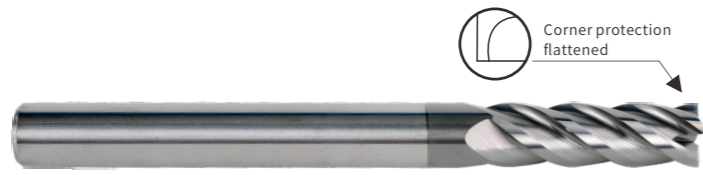

Suitable for side milling and shallow slot milling. Most suitable for high speed milling and dry milling.

helical angle $\angle 45^\circ$ diameter tolerance $D1\sim D6_{-0.02}^0 / D6\sim D14_{-0.025}^0 / D15\sim D20_{-0.03}^0$



part number	dimension (mm)				Number of flutes	Geometry	stock
	D	d	H	L			
OMH-4E-030L	3.0	6	12	75	4	fig 1	▲
OMH-4E-040L	4.0	6	15	75	4	fig 1	▲
OMH-4E-050L	5.0	6	20	75	4	fig 1	▲
OMH-4E-060L	6.0	6	20	75	4	fig 2	▲
OMH-4E-080L	8.0	8	25	100	4	fig 2	▲
OMH-4E-100L	10.0	10	30	100	4	fig 2	▲
OMH-4E-120L	12.0	12	35	100	4	fig 2	▲
OMH-4E-140L	14.0	14	40	100	4	fig 2	▲
OMH-4E-160L	16.0	16	50	150	4	fig 2	▲
OMH-4E-200L	20.0	20	55	150	4	fig2	▲

● Stock available ▲ Make-to-order

Workpiece material (○suitable, ◎very suitable)

Carbon steel	Alloy steel	Pre-hardened steel, Hardened steel				Stainless steel	Cast iron, nodular cast iron	copper alloy	Aluminum alloy	titanium alloy	Heat resistant alloy
		~40HRC	~50HRC	~55HRC	~68HRC						
○	○	◎	◎	◎	○	○					

OMH-4EH/G 4 flute long shank/ extra long shank flat end mill

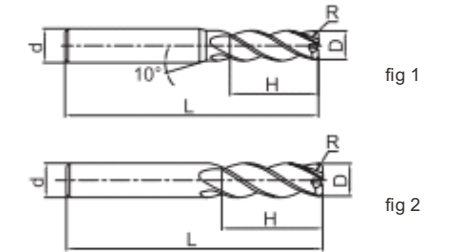

Suitable for side milling and shallow slot milling. Most suitable for high speed milling and dry milling.

helical angle $\angle 45^\circ$ diameter tolerance $D1\sim D6_{-0.02}^0 / D6\sim D14_{-0.025}^0 / D15\sim D20_{-0.03}^0$



part number	dimension (mm)				Number of flutes	Geometry	stock
	D	d	H	L			
OMH-4E-030SH	3.0	4	8	75	4	fig 2	●
OMH--4E-030H	3.0	6	8	75	4	fig 2	●
OMH-4E-040SH	4.0	4	11	75	4	fig 1	●
OMH-4E-040H	4.0	6	11	75	4	fig 2	●
OMH-4E-060H	6.0	6	16	75	4	fig 1	●
OMH-4E-060G	6.0	6	16	100	4	fig 1	●
OMH-4E-080H	8.0	8	20	75	4	fig 1	●
OMH-4E-080G	8.0	8	20	100	4	fig 1	●
OMH-4E-100H	10.0	10	25	100	4	fig 1	●
OMH-4E-100G	10.0	10	25	150	4	fig1	●
OMH-4E-120H	12.0	12	30	100	4	fig 1	●
OMH-4E-120G	12.0	12	30	150	4	fig1	●

● Stock available ▲ Make-to-order

Workpiece material (○suitable, ◎very suitable)

Carbon steel	Alloy steel	Pre-hardened steel, Hardened steel				Stainless steel	Cast iron, nodular cast iron	copper alloy	Aluminum alloy	titanium alloy	Heat resistant alloy
		~40HRC	~50HRC	~55HRC	~68HRC						
○	○	◎	◎	◎	○	○					

OMH-4EH/G 4 flute long shank/ extra long shank flat end mill

OMH-4E/4EL/4EG/4EH recommend cutting parameters

Workpiece material	Pre-hardened steel, hardened steel 40-50HRC		Hardened steel 50-60HRC		Hardened steel 60-68HRC	
	Diameter (mm)	Rotating speed (min-1)	Feedspeed (mm/min)	Rotating speed (min-1)	Feedspeed (mm/min)	Rotating speed (min-1)
1	40000	320	40000	320	32000	260
2	40000	800	24000	480	16000	320
3	32000	1020	16000	510	11000	350
4	24000	1250	12000	620	8000	420
5	19000	1360	9500	680	6400	460
6	16000	1540	8000	770	5300	510
8	12000	1540	6000	770	4000	510
10	9600	1540	4800	770	3200	510
12	8000	1600	4000	800	2700	540
14	6800	1340	3400	680	2300	460
16	6000	1200	3000	600	2000	400
18	5300	1060	2700	530	1800	360
20	4800	960	2400	480	1600	320

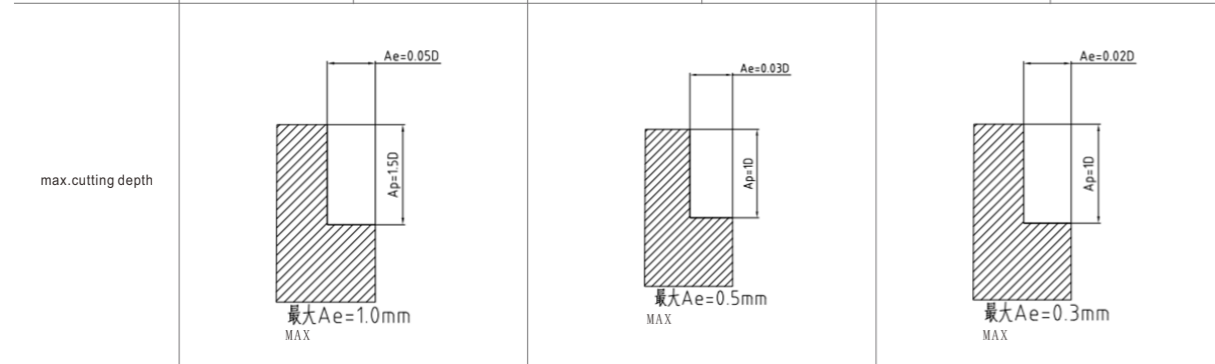

- 1 Please select high-precision machine and tool holder.
- 2 Please use air cooling or MQL (minimum oil mist cooling)
- 3 climb milling is recommended in the case of side milling.
- 4 When the machine rigidity and workpiece fixture stability is low, vibration and abnormal noise may be generated.
- 5 Please reduce the rotating speed and feed rate stated above correspondingly.
- 6 Make overhang of tool as short as possible in conditions of non-interference.

OMH-4R 4 flutes straight shank corner radius end mill

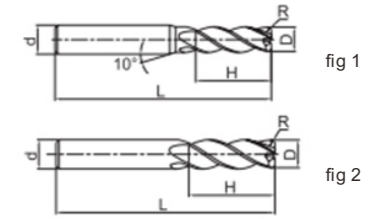
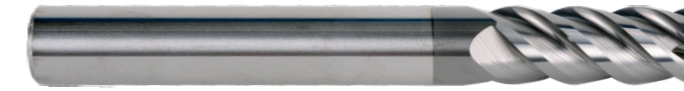

wide range of applications, able to achieve various forms of processing

helical angle $\angle 35^\circ$ diameter tolerance $D1\sim D6_{-0.02}^0 / D7\sim D20_{-0.025}^0$



part number	dimension (mm)					Number of flutes	Geometry	stock
	D	d	H	L	R			
OMH-4R-010R0.2S	1.0	4	3	50	0.2	4	fig 1	●
OMH-4R-015R0.2S	1.5	4	4	50	0.2	4	fig 1	●
OMH-4R-020R0.2S	2.0	4	6	50	0.2	4	fig 1	●
OMH-4R-020R0.5S	2.0	4	6	50	0.5	4	fig 1	●
OMH-4R-025R0.2S	2.5	4	8	50	0.2	4	fig 1	●
OMH-4R-025R0.5S	2.5	4	8	50	0.5	4	fig 1	●
OMH-4R-030R0.2S	3.0	4	8	50	0.2	4	fig 1	●
OMH-4R-030R0.5S	3.0	4	8	50	0.5	4	fig 1	●
OMH-4R-040R0.2S	4.0	4	10	50	0.2	4	fig 1	●
OMH-4R-040R0.3S	4.0	4	10	50	0.3	4	fig1	●
OMH-4R-040R0.5S	4.0	4	10	50	0.5	4	fig 1	●
OMH-4R-050R0.2	5.0	6	13	50	0.2	4	fig1	●
OMH-4R-050R0.5	5.0	6	13	50	0.5	4	fig 2	●
OMH-4R-050R1.0	5.0	6	13	50	1.0	4	fig 1	●
OMH-4R-060R0.2	6.0	6	16	50	0.2	4	fig 1	●
OMH-4R-060R0.5	6.0	6	16	50	0.5	4	fig1	●
OMH-4R-060R1.0	6.0	6	16	50	1.0	4	fig 2	●
OMH-4R-080R0.2	8.0	8	20	60	0.2	4	fig1	●
OMH-4R-080R0.5	8.0	8	20	60	0.5	4	fig 1	●
OMH-4R-080R1.0	8.0	8	20	60	1.0	4	fig 1	●
OMH-4R-100R0.2	10.0	10	25	75	0.2	4	fig 1	●
OMH-4R-100R0.5	10.0	10	25	75	0.5	4	fig1	●
OMH-4R-100R1.0	10.0	10	25	75	1.0	4	fig 2	●
OMH-4R-100R2.0	10.0	10	25	75	2.0	4	fig1	●
OMH-4R-100R3.0	10.0	10	25	75	3.0	4	fig 2	●
OMH-4R-120R0.2	12.0	12	30	75	0.2	4	fig 1	●
OMH-4R-120R0.5	12.0	12	30	75	0.5	4	fig 2	●
OMH-4R-120R1.0	12.0	12	30	75	1.0	4	fig1	●
OMH-4R-120R2.0	12.0	12	30	75	2.0	4	fig 2	●
OMH-4R-120R3.0	12.0	12	30	75	3.0	4	fig2	●

Workpiece material (○suitable, ◎very suitable)

Carbon steel	Alloy steel	Pre-hardened steel, Hardened steel				Stainless steel	Cast iron, nodular cast iron	copper alloy	Aluminum alloy	titanium alloy	Heat resistant alloy
		~40HRC	~50HRC	~55HRC	~68HRC						
○	○	◎	◎	◎	○	○					

OMH-4RH/G 4 flutes long shank /extra long shank corner radius end mill

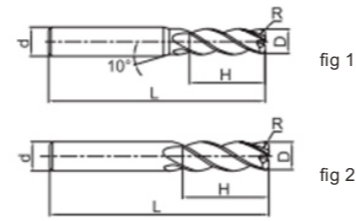
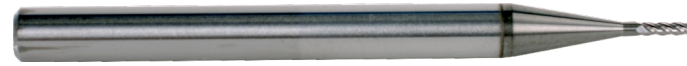

wide range of applications, able to achieve various forms of processing

helical angle $\angle 35^\circ$ diameter tolerance $D1\sim D6_{-0.02}^0 / D7\sim D20_{-0.025}^0$



part number	dimension (mm)					Number of flutes	Geometry	stock
	D	R	d	H	L			
OMH-4R-040R0.2SH	4.0	0.2	4	10	75	4	fig 1	●
OMH-4R-040R0.2H	4.0	0.2	6	10	75	4	fig 2	●
OMH-4R-040R0.5SH	4.0	0.5	4	10	75	4	fig 1	●
OMH-4R-040R0.5H	4.0	0.5	6	10	75	4	fig 2	●
OMH-4R-060R0.2H	6.0	0.2	6	16	75	4	fig 1	●
OMH-4R-060R0.2G	6.0	0.2	6	16	100	4	fig 1	●
OMH-4R-060R0.5H	6.0	0.5	6	16	75	4	fig 1	●
OMH-4R-060R0.5G	6.0	0.5	6	16	100	4	fig 1	●
OMH-4R-060R1.0H	6.0	1.0	6	16	75	4	fig 1	●
OMH-4R-060R1.0G	6.0	1.0	6	16	100	4	fig1	●
OMH-4R-080R0.2H	8.0	0.2	8	20	75	4	fig 1	●
OMH-4R-080R0.2G	8.0	0.2	8	20	100	4	fig1	●
OMH-4R-080R0.5H	8.0	0.5	8	20	75	4	fig 1	●
OMH-4R-080R0.5G	8.0	0.5	8	20	100	4	fig 1	●
OMH-4R-080R1.0H	8.0	1.0	8	20	75	4	fig 1	●
OMH-4R-080R1.0G	8.0	1.0	8	20	100	4	fig1	●

● Stock available ▲ Make-to-order

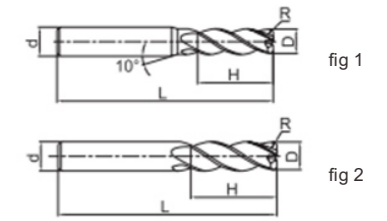
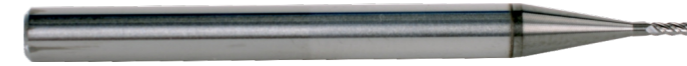

wide range of applications, able to achieve various forms of processing

helical angle $\angle 35^\circ$ diameter tolerance $D1\sim D6_{-0.02}^0 / D7\sim D20_{-0.025}^0$



part number	dimension (mm)					Number of flutes	Geometry	stock
	D	R	d	H	L			
OMH-4R-100R0.2H	10.0	0.2	10	25	100	4	fig 1	●
OMH-4R-100R0.2G	10.0	0.2	10	25	150	4	fig 1	●
OMH-4R-100R0.5H	10.0	0.5	10	25	100	4	fig 1	●
OMH-4R-100R0.5G	10.0	0.5	10	25	150	4	fig 1	●
OMH-4R-100R1.0H	10.0	1.0	10	25	100	4	fig 1	●
OMH-4R-100R1.0G	10.0	1.0	10	25	150	4	fig 1	●
OMH-4R-100R2.0H	10.0	2.0	10	25	100	4	fig 1	●
OMH-4R-100R2.0G	10.0	2.0	10	25	150	4	fig 1	●
OMH-4R-120R0.2H	12.0	0.2	12	30	100	4	fig 1	●
OMH-4R-120R0.2G	12.0	0.2	12	30	150	4	fig1	●
OMH-4R-120R0.5H	12.0	0.5	12	30	100	4	fig 1	●
OMH-4R-120R0.5G	12.0	0.5	12	30	150	4	fig1	●
OMH-4R-120R1.0H	12.0	1.0	12	30	100	4	fig 1	●
OMH-4R-120R1.0G	12.0	1.0	12	30	150	4	fig 1	●
OMH-4R-120R2.0H	12.0	2.0	12	30	100	4	fig 1	●
OMH-4R-120R2.0G	12.0	2.0	12	30	150	4	fig1	●

● Stock available ▲ Make-to-order

Workpiece material (○suitable, ◎very suitable)

Carbon steel	Alloy steel	Pre-hardened steel, Hardened steel				Stainless steel	Cast iron, nodular cast iron	copper alloy	Aluminum alloy	titanium alloy	Heat resistant alloy
		~40HRC	~50HRC	~55HRC	~68HRC						
○	○	◎	◎	◎		○	○				

OMH-4R, 4RH, 4RG recommend cutting parameters

Workpiece material	Pre-hardened steel, hardened steel 40-50HRC		Hardened steel 50-60HRC		Hardened steel 60-68HRC	
	Rotating speed (min-1)	Feedspeed (mm/min)	Rotating speed (min-1)	Feedspeed (mm/min)	Rotating speed (min-1)	Feedspeed (mm/min)
3	32000	1225	16000	610	11000	420
4	24000	1500	12000	745	8000	500
5	19000	1630	9500	815	6400	550
6	16000	1850	8000	925	5300	610
8	12000	1850	6000	925	4000	610
10	9600	1850	4800	925	3200	610
12	8000	1920	4000	960	2700	648
16	6000	1440	3000	720	2000	480

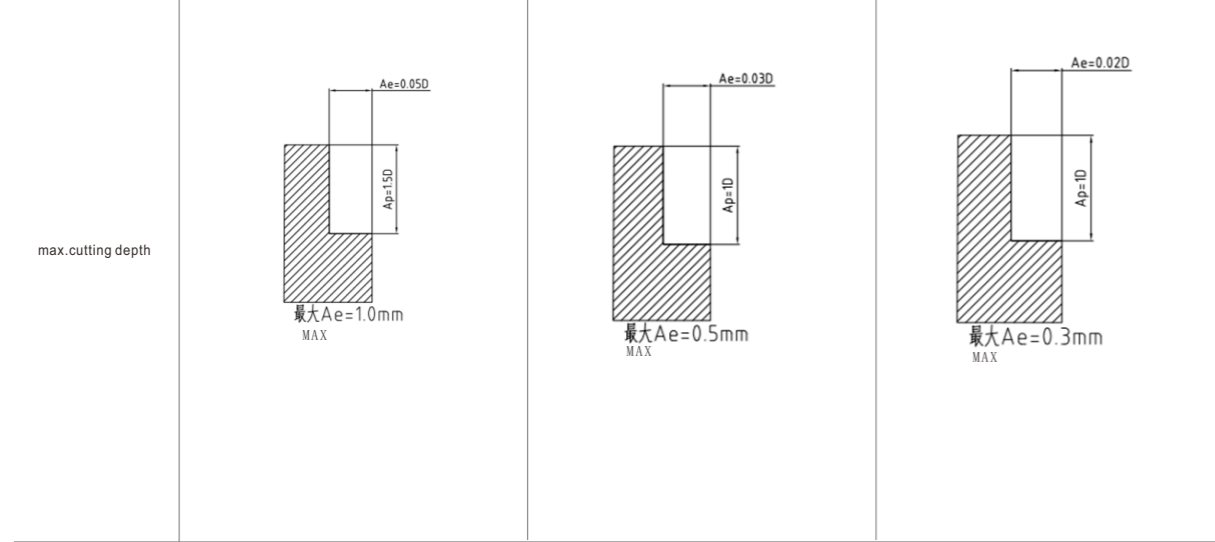

1. Please select high-precision machine and tool holder.
2. Please use air cooling or MQL (minimum oil mist cooling)
3. climb milling is recommended in the case of side milling.
4. When the machine rigidity and workpiece fixture stability is low, vibration and abnormal noise may be generated. Please reduce the rotating speed and feed rate stated above correspondingly.
5. Make overhang of tool as short as possible in conditions of non-interference.

OMH-2B 2 flutes straight shank ball head end mill



Suitable for profile milling, and high speed machining, with wide range of applications.

helical angle $\angle 30^\circ$ diameter tolerance $D1 \sim D20 \begin{matrix} 0 \\ -0.02 \end{matrix} R \pm 0.005$



part number	dimension (mm)					Number of flutes	Geometry	stock
	D	R	d	H	L			
OMH-2B-010R0.5S	1.0	0.5	4	2	50	2	fig 1	●
OMH-2B-010R0.5	1.0	0.5	6	2	50	2	fig 1	●
OMH-2B-015R0.75S	1.5	0.75	4	3	50	2	fig 1	●
OMH-2B-015R0.75	1.5	0.75	6	3	50	2	fig 1	●
OMH-2B-020R1.0S	2.0	1.0	4	4	50	2	fig 1	●
OMH-2B-020R1.0	2.0	1.0	6	4	50	2	fig 1	●
OMH-2B-025R1.25S	2.5	1.25	4	5	50	2	fig 1	●
OMH-2B-025R1.25	2.5	1.25	6	5	50	2	fig 1	●
OMH-2B-030R1.5S	3.0	1.5	4	6	50	2	fig 1	●
OMH-2B-030R1.5	3.0	1.5	6	6	50	2	fig 1	●
OMH-2B-035R1.75	3.5	1.75	6	8	50	2	fig 1	●
OMH-2B-040R2.0S	4.0	2.0	4	8	50	2	fig 2	●
OMH-2B-040R2.0	4.0	2.0	6	8	50	2	fig 1	●
OMH-2B-050R2.5	5.0	2.5	6	10	50	2	fig 1	●
OMH-2B-055R2.75	5.5	2.75	6	12	50	2	fig 1	●
OMH-2B-060R3.0	6.0	3.0	6	12	50	2	fig 2	●
OMH-2B-070R3.5	7.0	3.5	8	14	60	2	ig 1	●
OMH-2B-080R4.0	8.0	4.0	8	16	60	2	fig 2	●
OMH-2B-090R4.5	9.0	4.5	10	18	75	2	fig 1	●
OMH-2B-100R5.0	10.0	5.0	10	20	75	2	fig 2	●
OMH-2B-120R6.0	12.0	6.0	12	24	75	2	ig 2	●
OMH-2B-140R7.0	14.0	7.0	14	28	75	2	fig 2	●
OMH-2B-160R8.0	16.0	8.0	16	32	100	2	fig 2	●
OMH-2B-200R10.0	20.0	10.0	20	40	100	2	fig 2	●

Workpiece material (○suitable, ●very suitable)

Carbon steel	Alloy steel	Pre-hardened steel, Hardened steel				Stainless steel	Cast iron, nodular cast iron	copper alloy	Aluminum alloy	titanium alloy	Heat resistant alloy
		~40HRC	~50HRC	~55HRC	~68HRC						
○	○	●	●	●	○	○					

OMH-2BH/G 2 flutes long shank/extra long shank ball head end mill

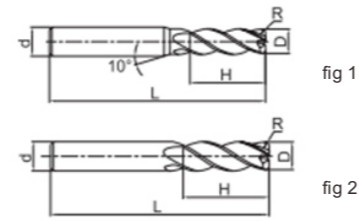
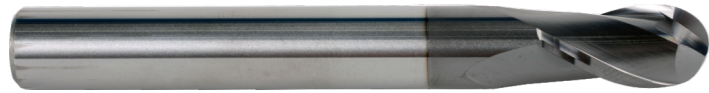

Suitable for profile milling, and high speed machining, with wide range of applications.

helical angle $\angle 30^\circ$ diameter tolerance $D1 \sim D20 \begin{matrix} 0 \\ -0.02 \end{matrix} R \pm 0.005$



part number	dimension (mm)					Number of flutes	Geometry	stock
	D	R	d	H	L			
OMH-2B-020R1.0SH	2.0	1.0	4	4	75	2	fig 1	●
OMH-2B-020R1.0H	2.0	1.0	6	4	75	2	fig 1	●
OMH-2B-025R1.25SH	2.5	1.25	4	5	75	2	fig 1	●
OMH-2B-025R1.25H	2.5	1.25	6	5	75	2	fig 1	●
OMH-2B-030R1.5SH	3.0	1.5	4	6	75	2	fig 1	●
OMH-2B-030R1.5H	3.0	1.5	6	6	75	2	fig 1	●
OMH-2B-035R1.75SH	3.5	1.75	4	8	75	2	fig 1	●
OMH-2B-035R1.75H	3.5	1.75	6	8	75	2	fig 1	●
OMH-2B-040R2.0SH	4.0	2.0	4	8	75	2	fig 2	●
OMH-2B-040R2.0H	4.0	2.0	6	8	75	2	fig1	●
OMH-2B-050R2.5H	5.0	2.5	6	10	75	2	fig 1	●
OMH-2B-055R2.75H	5.5	2.75	6	12	75	2	fig2	●
OMH-2B-060R3.0H	6.0	3.0	6	12	75	2	fig 2	●
OMH-2B-070R3.5H	7.0	3.5	8	14	75	2	fig 1	●
OMH-2B-080R4.0H	8.0	4.0	8	16	75	2	fig 2	●
OMH-2B-090R4.5H	9.0	4.5	10	18	100	2	fig2	●
OMH-2B-100R5.0H	10.0	5.0	10	20	100	2	fig 2	●
OMH-2B-120R6.0H	12.0	6.0	12	24	100	2	fig 2	●
OMH-2B-140R7.0H	14.0	7.0	14	28	150	2	fig 2	●
OMH-2B-160R8.0H	16.0	8.0	16	32	150	2	fig2	●
OMH-2B-200R10.0H	20.0	10.0	20	40	150	2	fig 2	●
OMH-2B-060R3.0G	6.0	3.0	6	12	100	2	fig 2	●
OMH-2B-080R4.0G	8.0	4.0	8	16	100	2	fig 2	●
OMH-2B-100R5.0G	10.0	5.0	10	20	150	2	fig2	●
OMH-2B-120R6.0G	12.0	6.0	12	24	150	2	fig2	●

●Stock available▲Make-to-order

Workpiece material (○suitable, ◎very suitable)

Carbon steel	Alloy steel	Pre-hardened steel, Hardened steel				Stainless steel	Cast iron, nodular cast iron	copper alloy	Aluminum alloy	titanium alloy	Heat resistant alloy
		~40HRC	~50HRC	~55HRC	~68HRC						
○	○	◎	◎	◎	○	○					

OMH-2B/2BH/G recommend cutting parameters

Workpiece material	Pre-hardened steel, hardened steel 40-50HRC				Hardened steel 50-60HRC				Hardened steel 60-68HRC			
	Diameter (mm)	Rotating speed (min-1)	Feedspeed (mm/min)	Ap (mm)	Ae (mm)	Rotating speed (min-1)	Feedspeed (mm/min)	Ap (mm)	Ae (mm)	Rotating speed (min-1)	Feedspeed (mm/min)	Ap (mm)
R0.5	40000	1900	0.01	0.05	36000	1500	0.01	0.05	32000	1400	0.01	0.05
R1.0	33000	3100	0.02	0.075	26000	2100	0.02	0.075	24000	2000	0.02	0.075
R1.5	29000	4100	0.03	0.1	23000	2900	0.03	0.1	21000	2600	0.03	0.1
R2.0	22000	3900	0.04	0.15	17000	2500	0.04	0.15	15500	2100	0.04	0.15
R2.5	17500	3500	0.05	0.15	13500	2200	0.05	0.15	13000	2000	0.05	0.15
R3.0	15000	3100	0.06	0.2	11500	1700	0.06	0.2	10500	1500	0.06	0.2
R4.0	11000	2500	0.08	0.25	8600	1600	0.08	0.25	8000	1400	0.08	0.25
R5.0	9000	2000	0.1	0.3	7000	1400	0.1	0.3	6000	1200	0.1	0.3
R6.0	7500	1800	0.1	0.35	5700	1300	0.1	0.35	5300	1200	0.1	0.35
R8.0	5500	1800	0.1	0.4	4300	1300	0.1	0.4	4000	1200	0.1	0.4
R10.0	4500	1800	0.1	0.5	3500	1300	0.1	0.5	3200	1200	0.1	0.5

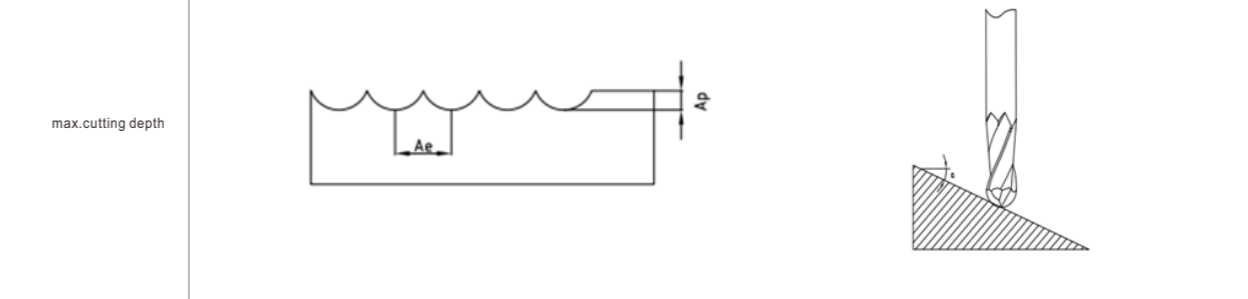

1. Please select high-precision machine and tool holder.
2. When the machine rigidity and workpiece fixture stability is low, vibration and abnormal noise may be generated. Please reduce the rotating speed and feed rate stated above correspondingly.
3. Please use air cooling or MQL (minimum oil mist cooling)
- 4 If inclination angle α over 15° , please reduce the speed to 50%-80% of above table.
- 5 Make overhang of tool as short as possible in conditions of non-interference.

OMHH series for High-hardened steel

Product features and application range

OMHH is suitable for finishing and semi-finishing machining of 55~63HRC quenched steel and High-hardened steel

1. New ultra fine cemented carbide substrate

- ① New ultra fine cemented carbide substrate, Wc grain size is 0.2μm
- ② Ultra-high hardness substrate material, micro-hardness > 2050HV;
- ③ Super high strength and toughness, tensile strength > 4200N/MM

2. Fine cutting edge surface treatment

- ① Smooth rake face surface, smooth chip removal, less cutting resistance;
- ② The stress between coating and substrate is improved
- ③ Reduce cutting viscosity.

3. High-rigidity and high-strength cutting edge structure design

- ① Ensuring sufficient chip space, meanwhile adopt large core body to improve the tool rigidity;
- ② negative rake angle, which makes the cutting edge strength and cutting force match reasonably, and gives a wider range of applications;
- ③ Strict and scientific chip breaker geometric design, gives more stable cutting.

OMHH-4E 4 flutes straight flat head end mill

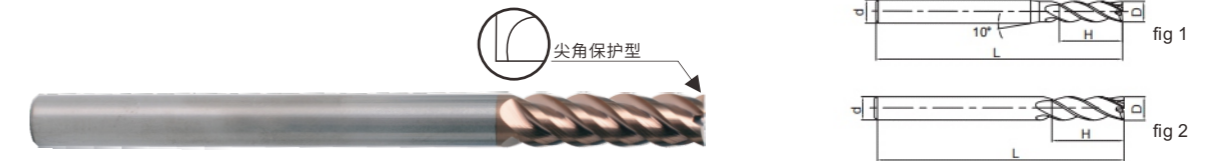

Suitable for side milling and shallow slot milling.
Most suitable for high speed milling and dry milling.

helical angle $\angle 45^\circ$ diameter tolerance $D1\sim D6_{-0.02}^0 / D6\sim D14_{-0.025}^0 / D15\sim D20_{-0.03}^0$

part number	dimension (mm)				Number of flutes	Geometry	stock
	D	d	H	L			
OMHH-4E-010F	1.0	3	3	50	4	fig 1	●
OMHH-4E-010S	1.0	4	3	50	4	fig 1	●
OMHH-4E-010	1.0	6	3	50	4	fig 1	●
OMHH-4E-015F	1.5	3	4	50	4	fig 1	●
OMHH-4E-015S	1.5	4	4	50	4	fig 1	●
OMHH-4E-015	1.5	6	4	50	4	fig 1	●
OMHH-4E-020F	2.0	3	6	50	4	fig 1	●
OMHH-4E-020S	2.0	4	6	50	4	fig 1	●
OMHH-4E-020	2.0	6	6	50	4	fig 1	●
OMHH-4E-025F	2.5	3	8	50	4	fig1	●
OMHH-4E-025S	2.5	4	8	50	4	fig 1	●
OMHH-4E-025	2.5	6	8	50	4	fig1	●
OMHH-4E-030F	3.0	3	8	50	4	fig2	●
OMHH-4E-030S	3.0	4	8	50	4	fig1	●
OMHH-4E-030	3.0	6	8	50	4	fig1	●
OMHH-4E-035S	3.5	4	10	50	4	fig1	●
OMHH-4E-040S	4.0	4	11	50	4	fig2	●
OMHH-4E-035	3.5	6	10	50	4	fig1	●
OMHH-4E-040	4.0	6	11	50	4	fig1	●
OMHH-4E-045	4.5	6	11	50	4	fig1	●
OMHH-4E-050	5.0	6	13	50	4	fig1	●
OMHH-4E-055	5.5	6	16	50	4	fig1	●
OMHH-4E-060	6.0	6	16	50	4	fig2	●
OMHH-4E-070	7.0	8	20	60	4	fig1	●
OMHH-4E-080	8.0	8	20	60	4	fig2	●
OMHH-4E-090	9.0	10	22	75	4	fig1	●
OMHH-4E-100	10.0	10	25	75	4	fig2	●
OMHH-4E-110	11.0	12	26	75	4	fig1	●
OMHH-4E-120	12.0	12	30	75	4	fig2	●
OMHH-4E-140	14.0	14	32	75	4	fig2	●
OMHH-4E-160	16.0	16	45	100	4	fig2	●
OMHH-4E-180	18.0	18	45	100	4	fig2	●
OMHH-4E-200	20.0	20	45	100	4	fig2	●

● Stock available ▲ Make-to-order

Workpiece material (○suitable, ◎very suitable)

Carbon steel	Alloy steel	Pre-hardened steel, Hardened steel				Stainless steel	Cast iron, nodular cast iron	copper alloy	Aluminum alloy	titanium alloy	Heat resistant alloy
		~40HRC	~50HRC	~55HRC	~68HRC						
○	○	◎	◎	◎	◎	○	○				



OMHH-4EL 4 flutes long cutting edge flat end mill

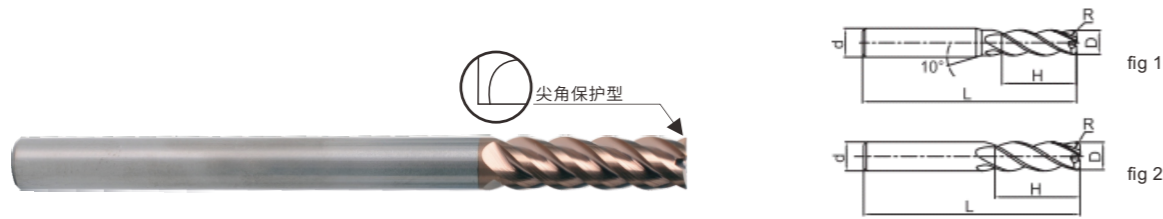

Suitable for side milling and shallow slot milling.
Most suitable for high speed milling and dry milling.

helical angle $\angle 45^\circ$ diameter tolerance $D1\sim D6_{-0.02}^0 / D6\sim D14_{-0.025}^0 / D15\sim D20_{-0.03}^0$



part number	dimension (mm)				Number of flutes	Geometry	stock
	D	d	H	L			
OMHH-4E-030L	3.0	6	12	75	4	fig 1	▲
OMHH-4E-040L	4.0	6	15	75	4	fig 1	▲
OMHH-4E-050L	5.0	6	20	75	4	fig 1	▲
OMHH-4E-060L	6.0	6	20	75	4	fig 2	▲
OMHH-4E-080L	8.0	8	25	100	4	fig 2	▲
OMHH-4E-100L	10.0	10	30	100	4	fig 2	▲
OMHH-4E-120L	12.0	12	35	100	4	fig2	▲
OMHH-4E-140L	14.0	14	40	100	4	fig 2	▲
OMHH-4E-160L	16.0	16	50	150	4	fig 2	▲
OMHH-4E-200L	20.0	20	55	150	4	fig2	▲

● Stock available ▲ Make-to-order

OMHH-4EH/G 4 flutes long shank /extra long shank flat end mill

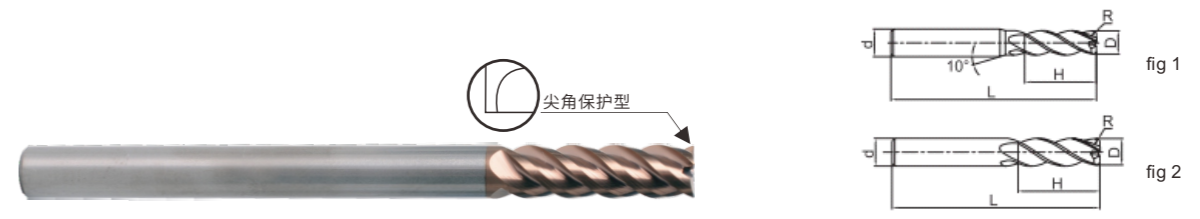

Suitable for side milling and shallow slot machining.
Most suitable for high speed milling and dry milling.

helical angle $\angle 45^\circ$ diameter tolerance $D1\sim D6_{-0.02}^0 / D6\sim D14_{-0.025}^0 / D15\sim D20_{-0.03}^0$



part number	dimension (mm)				Number of flutes	Geometry	stock
	D	d	H	L			
OMHH-4E-030SH	3.0	4	8	75	4	fig 2	●
OMHH--4E-030H	3.0	6	8	75	4	fig 2	●
OMHH-4E-040SH	4.0	4	11	75	4	fig 1	●
OMHH-4E-040H	4.0	6	11	75	4	fig 2	●
OMHH-4E-060H	6.0	6	16	75	4	fig 1	●
OMHH-4E-060G	6.0	6	16	100	4	fig 1	●
OMHH-4E-080H	8.0	8	20	75	4	fig 1	●
OMHH-4E-080G	8.0	8	20	100	4	fig 1	●
OMHH-4E-100H	10.0	10	25	100	4	fig 1	●
OMHH-4E-100G	10.0	10	25	150	4	fig1	●
OMHH-4E-120H	12.0	12	30	100	4	fig 1	●
OMHH-4E-120G	12.0	12	30	150	4	fig1	●

● Stock available ▲ Make-to-order

Workpiece material (○suitable、◎very suitable)

Carbon steel	Alloy steel	Pre-hardened steel, Hardened steel				Stainless steel	Cast iron, nodular cast iron	copper alloy	Aluminum alloy	titanium alloy	Heat resistant alloy
		~40HRC	~50HRC	~55HRC	~68HRC						
○	○	◎	◎	◎	◎	○	○				

Workpiece material (○suitable、◎very suitable)

Carbon steel	Alloy steel	Pre-hardened steel, Hardened steel				Stainless steel	Cast iron, nodular cast iron	copper alloy	Aluminum alloy	titanium alloy	Heat resistant alloy
		~40HRC	~50HRC	~55HRC	~68HRC						
○	○	◎	◎	◎	◎		○				

OMHH-4R 4 flutes straight shank corner radius end mill

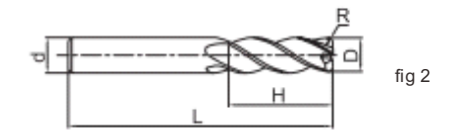
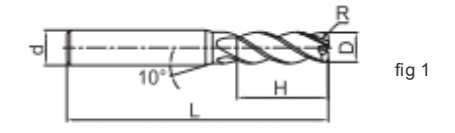

wide range of applications, able to achieve various forms of processing

helical angle $\angle 35^\circ$ diameter tolerance $D1\sim D6_{-0.02}^0 / D7\sim D20_{-0.025}^0$



OMHH-4E/4EL/4EG/4EH recommend cutting parameters

Workpiece material	Pre-hardened steel, hardened steel 40-50HRC		Hardened steel 50-60HRC		Hardened steel 60-68HRC	
	Rotating speed (min-1)	Feedspeed (mm/min)	Rotating speed (min-1)	Feedspeed (mm/min)	Rotating speed (min-1)	Feedspeed (mm/min)
1	40000	320	40000	320	32000	260
2	40000	800	24000	480	16000	320
3	32000	1020	16000	510	11000	350
4	24000	1250	12000	620	8000	420
5	19000	1360	9500	680	6400	460
6	16000	1540	8000	770	5300	510
8	12000	1540	6000	770	4000	510
10	9600	1540	4800	770	3200	510
12	8000	1600	4000	800	2700	540
14	6800	1340	3400	680	2300	460
16	6000	1200	3000	600	2000	400
18	5300	1060	2700	530	1800	360
20	4800	960	2400	480	1600	320

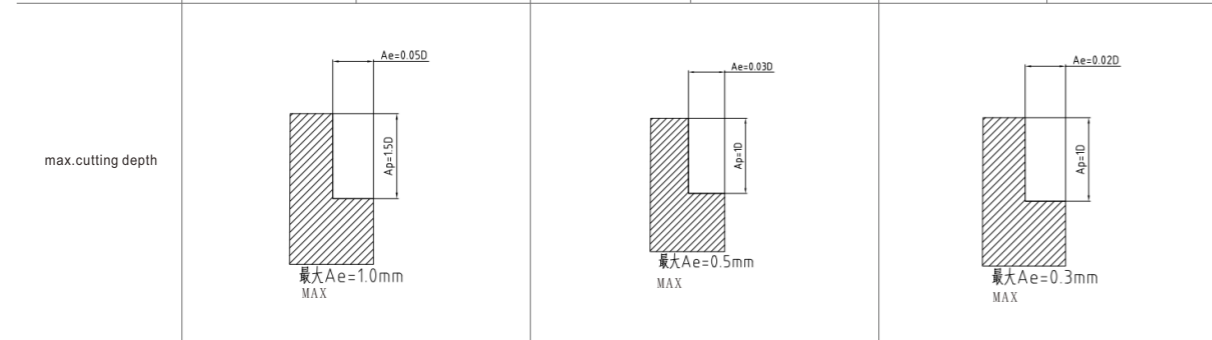

- 1Please select high-precision machine and tool holder.
- 2Please use air cooling or MQL (minimum oil mist cooling)
- 3climb milling is recommended in the case of side milling.
- 4When the machine rigidity and workpiece fixture stability is low, vibration and abnormal noise may be generated. Please reduce the rotating speed and feed rate stated above correspondingly.
- 5Make overhang of tool as short as possible in conditions of non-interference.

part number	dimension (mm)					Number of flutes	Geometry	stock
	D	R	H	L	d			
OMHH-4R-010R0.2S	1.0	0.2	3	50	4	4	fig 1	●
OMHH-4R-015R0.2S	1.5	0.2	4	50	4	4	fig 1	●
OMHH-4R-020R0.2S	2.0	0.2	6	50	4	4	fig 1	●
OMHH-4R-020R0.5S	2.0	0.5	6	50	4	4	fig 1	●
OMHH-4R-025R0.2S	2.5	0.2	8	50	4	4	fig 1	●
OMHH-4R-025R0.5S	2.5	0.5	8	50	4	4	fig 1	●
OMHH-4R-030R0.2S	3.0	0.2	8	50	4	4	fig 1	●
OMHH-4R-030R0.5S	3.0	0.5	8	50	4	4	fig 1	●
OMHH-4R-040R0.2S	4.0	0.2	10	50	4	4	fig 1	●
OMHH-4R-040R0.3S	4.0	0.3	10	50	4	4	fig 1	●
OMHH-4R-040R0.5S	4.0	0.5	10	50	4	4	fig 1	●
OMHH-4R-050R0.2	5.0	0.2	13	50	6	4	fig 1	●
OMHH-4R-050R0.5	5.0	0.5	13	50	6	4	fig 2	●
OMHH-4R-050R1.0	5.0	1.0	13	50	6	4	fig 1	●
OMHH-4R-060R0.2	6.0	0.2	16	50	6	4	fig 1	●
OMHH-4R-060R0.5	6.0	0.5	16	50	6	4	fig 1	●
OMHH-4R-060R1.0	6.0	1.0	16	50	6	4	fig 2	●
OMHH-4R-080R0.2	8.0	0.2	20	60	8	4	fig 1	●
OMHH-4R-080R0.5	8.0	0.5	20	60	8	4	fig 1	●
OMHH-4R-080R1.0	8.0	1.0	20	60	8	4	fig 1	●
OMHH-4R-100R0.2	10.0	0.2	25	75	10	4	fig 1	●
OMHH-4R-100R0.5	10.0	0.5	25	75	10	4	fig 1	●
OMHH-4R-100R1.0	10.0	1.0	25	75	10	4	fig 2	●
OMHH-4R-100R2.0	10.0	2.0	25	75	10	4	fig 1	●
OMHH-4R-100R3.0	10.0	3.0	25	75	10	4	fig 2	●
OMHH-4R-120R0.2	12.0	0.2	30	75	12	4	fig 1	●
OMHH-4R-120R0.5	12.0	0.5	30	75	12	4	fig 2	●
OMHH-4R-120R1.0	12.0	1.0	30	75	12	4	fig 1	●
OMHH-4R-120R2.0	12.0	2.0	30	75	12	4	fig 2	●
OMHH-4R-120R3.0	12.0	3.0	30	75	12	4	fig 2	●

● Stock available ▲ Make-to-order

Workpiece material (○suitable, ◎very suitable)

Carbon steel	Alloy steel	Pre-hardened steel, Hardened steel				Stainless steel	Cast iron, nodular cast iron	copper alloy	Aluminum alloy	titanium alloy	Heat resistant alloy
		~40HRC	~50HRC	~55HRC	~68HRC						
○	○	◎	◎	◎	◎		○				

OMHH-4RH/G 4 flutes long shank /extra long shank corner radius end mill

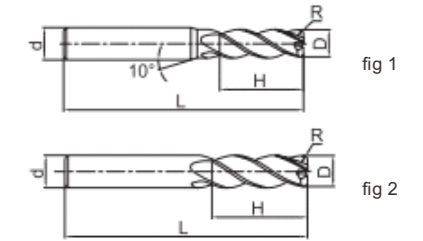

wide range of applications, able to achieve various forms of processing

helical angle $\angle 35^\circ$ diameter tolerance $D1\sim D6_{-0.02}^0 / D7\sim D20_{-0.025}^0$



part number	dimension (mm)					Number of flutes	Geometry	stock
	D	R	d	H	L			
OMHH-4R-040R0.2SH	4.0	0.2	4	10	75	4	fig 1	●
OMHH-4R-040R0.2H	4.0	0.2	6	10	75	4	fig 2	●
OMHH-4R-040R0.5SH	4.0	0.5	4	10	75	4	fig 1	●
OMHH-4R-040R0.5H	4.0	0.5	6	10	75	4	fig 2	●
OMHH-4R-060R0.2H	6.0	0.2	6	16	75	4	fig 1	●
OMHH-4R-060R0.2G	6.0	0.2	6	16	100	4	fig 1	●
OMHH-4R-060R0.5H	6.0	0.5	6	16	75	4	fig 1	●
OMHH-4R-060R0.5G	6.0	0.5	6	16	100	4	fig 1	●
OMHH-4R-060R1.0H	6.0	1.0	6	16	75	4	fig 1	●
OMHH-4R-060R1.0G	6.0	1.0	6	16	100	4	fig1	●
OMHH-4R-080R0.2H	8.0	0.2	8	20	75	4	fig 1	●
OMHH-4R-080R0.2G	8.0	0.2	8	20	100	4	fig 1	●
OMHH-4R-080R0.5H	8.0	0.5	8	20	75	4	fig 1	●
OMHH-4R-080R0.5G	8.0	0.5	8	20	100	4	fig 1	●
OMHH-4R-080R1.0H	8.0	1.0	8	20	75	4	fig 1	●
OMHH-4R-080R1.0G	8.0	1.0	8	20	100	4	fig1	●
OMHH-4R-100R0.2H	10.0	0.2	10	25	100	4	fig 1	●
OMHH-4R-100R0.2G	10.0	0.2	10	25	150	4	fig 1	●
OMHH-4R-100R0.5H	10.0	0.5	10	25	100	4	fig 1	●
OMHH-4R-100R0.5G	10.0	0.5	10	25	150	4	fig 1	●
OMHH-4R-100R1.0H	10.0	1.0	10	25	100	4	fig 1	●
OMHH-4R-100R1.0G	10.0	1.0	10	25	150	4	fig1	●
OMHH-4R-100R2.0H	10.0	2.0	10	25	100	4	fig 1	●
OMHH-4R-100R2.0G	10.0	2.0	10	25	150	4	fig 1	●
OMHH-4R-120R0.2H	12.0	0.2	12	30	100	4	fig 1	●
OMHH-4R-120R0.2G	12.0	0.2	12	30	150	4	fig 1	●
OMHH-4R-120R0.5H	12.0	0.5	12	30	100	4	fig 1	●
OMHH-4R-120R0.5G	12.0	0.5	12	30	150	4	fig1	●
OMHH-4R-120R1.0H	12.0	1.0	12	30	100	4	fig 1	●
OMHH-4R-120R1.0G	12.0	1.0	12	30	150	4	fig 1	●
OMHH-4R-120R2.0H	12.0	2.0	12	30	100	4	fig 1	●
OMHH-4R-120R2.0G	12.0	2.0	12	30	150	4	fig 1	●

●Stock available▲Make-to-order

Workpiece material (○suitable, ◎very suitable)

Carbon steel	Alloy steel	Pre-hardened steel, Hardened steel				Stainless steel	Cast iron, nodular cast iron	copper alloy	Aluminum alloy	titanium alloy	Heat resistant alloy
		~40HRC	~50HRC	~55HRC	~68HRC						
○	○	◎	◎	◎	◎	○	○				

OMHH-4R, 4RH, 4RG recommend cutting parameters

Workpiece material	Pre-hardened steel, hardened steel 40~50HRC		Hardened steel 50~60HRC		Hardened steel 60~68HRC	
	Diameter (mm)	Rotating speed (min ⁻¹)	Feedspeed (mm/min)	Rotating speed (min ⁻¹)	Feedspeed (mm/min)	Rotating speed (min ⁻¹)
3	32000	1225	16000	610	11000	420
4	24000	1500	12000	745	8000	500
5	19000	1630	9500	815	6400	550
6	16000	1850	8000	925	5300	610
8	12000	1850	6000	925	4000	610
10	9600	1850	4800	925	3200	610
12	8000	1920	4000	960	2700	648
16	6000	1440	3000	720	2000	480

max. cutting depth	Ae=0.05D		Ae=0.03D		Ae=0.02D	
	Diagram	MAX Ae	Diagram	MAX Ae	Diagram	MAX Ae
		1.0mm		0.5mm		0.3mm

- Please select high-precision machine and tool holder.
- Please use air cooling or MQL (minimum oil mist cooling)
- climb milling is recommended in the case of side milling.
- When the machine rigidity and workpiece fixture stability is low, vibration and abnormal noise may be generated. Please reduce the rotating speed and feed rate stated above correspondingly.
- Make overhang of tool as short as possible in conditions of non-interference.

OMHH-2B 2 flutes straight shank ball head end mill



Suitable for profile milling. Most suitable for high speed milling and dry milling.

螺旋角 $\angle 35^\circ$ 直径公差 $D1 \sim D20 \begin{matrix} 0 \\ -0.02 \end{matrix}$ $R \pm 0.005$
 helical angle diameter tolerance

part number	dimension (mm)					Number of flutes	Geometry	stock
	D	R	d	H	L			
OMHH-2B-010R0.5S	1.0	0.5	4	2	50	2	fig 1	●
OMHH-2B-010R0.5	1.0	0.5	6	2	50	2	fig 1	●
OMHH-2B-015R0.75S	1.5	0.75	4	3	50	2	fig 1	●
OMHH-2B-015R0.75	1.5	0.75	6	3	50	2	fig 1	●
OMHH-2B-020R1.0S	2.0	1.0	4	4	50	2	fig 1	●
OMHH-2B-020R1.0	2.0	1.0	6	4	50	2	fig 1	●
OMHH-2B-025R1.25S	2.5	1.25	4	5	50	2	fig 1	●
OMHH-2B-025R1.25	2.5	1.25	6	5	50	2	fig 1	●
OMHH-2B-030R1.5S	3.0	1.5	4	6	50	2	fig 1	●
OMHH-2B-030R1.5	3.0	1.5	6	6	50	2	fig1	●
OMHH-2B-035R1.75	3.5	1.75	6	8	50	2	fig 1	●
OMHH-2B-040R2.0S	4.0	2.0	4	8	50	2	fig 2	●
OMHH-2B-040R2.0	4.0	2.0	6	8	50	2	fig 1	●
OMHH-2B-050R2.5	5.0	2.5	6	10	50	2	fig 1	●
OMHH-2B-055R2.75	5.5	2.75	6	12	50	2	fig 1	●
OMHH-2B-060R3.0	6.0	3.0	6	12	50	2	fig2	●
OMHH-2B-070R3.5	7.0	3.5	8	14	60	2	fig1	●
OMHH-2B-080R4.0	8.0	4.0	8	16	60	2	fig 2	●
OMHH-2B-090R4.5	9.0	4.5	10	18	75	2	fig 1	●
OMHH-2B-100R5.0	10.0	5.0	10	20	75	2	fig 2	●
OMHH-2B-120R6.0	12.0	6.0	12	24	75	2	fig 2	●
OMHH-2B-140R7.0	14.0	7.0	14	28	75	2	fig 2	●
OMHH-2B-160R8.0	16.0	8.0	16	32	100	2	fig2	●
OMHH-2B-200R10.0	20.0	10.0	20	40	100	2	fig2	●

● Stock available ▲ Make-to-order

Workpiece material (○suitable, ◎very suitable)

Carbon steel	Alloy steel	Pre-hardened steel, Hardened steel				Stainless steel	Cast iron, nodular cast iron	copper alloy	Aluminum alloy	titanium alloy	Heat resistant alloy
		~40HRC	~50HRC	~55HRC	~68HRC						
○	○	◎	◎	◎	◎	○	○				

OMHH-2BH/G 2 flutes long shank/extra long shank ball head end mill

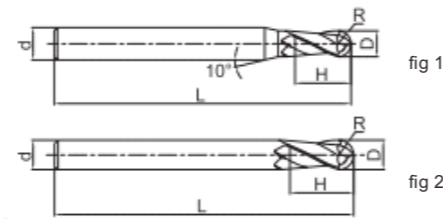
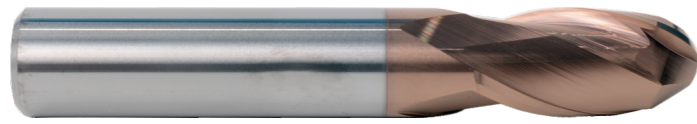

Suitable for profile milling. Most suitable for high speed milling and dry milling.

helical angle $\angle 35^\circ$ diameter tolerance $D1 \sim D20 \begin{matrix} 0 \\ -0.02 \end{matrix}$ $R \pm 0.005$



part number	dimension (mm)					Number of flutes	Geometry	stock
	D	R	d	H	L			
OMHH-2B-020R1.0SH	2.0	1.0	4	4	75	2	fig 1	●
OMHH-2B-020R1.0H	2.0	1.0	6	4	75	2	fig 1	●
OMHH-2B-025R1.25SH	2.5	1.25	4	5	75	2	fig 1	●
OMHH-2B-025R1.25H	2.5	1.25	6	6	75	2	fig 1	●
OMHH-2B-030R1.5SH	3.0	1.5	4	6	75	2	fig 1	●
OMHH-2B-030R1.5H	3.0	1.5	6	6	75	2	fig 1	●
OMHH-2B-035R1.75SH	3.5	1.75	4	8	75	2	fig 1	●
OMHH-2B-035R1.75H	3.5	1.75	6	8	75	2	fig 1	●
OMHH-2B-040R2.0SH	4.0	2.0	4	8	75	2	fig 2	●
OMHH-2B-040R2.0H	4.0	2.0	6	8	75	2	fig 1	●
OMHH-2B-050R2.5H	5.0	2.5	6	10	75	2	fig 1	●
OMHH-2B-055R2.75H	5.5	2.75	6	12	75	2	fig 1	●
OMHH-2B-060R3.0H	6.0	3.0	6	12	75	2	fig 2	●
OMHH-2B-070R3.5H	7.0	3.5	8	14	75	2	fig 1	●
OMHH-2B-080R4.0H	8.0	4.0	8	16	75	2	fig 2	●
OMHH-2B-090R4.5H	9.0	4.5	10	18	100	2	fig 1	●
OMHH-2B-100R5.0H	10.0	5.0	10	20	100	2	fig 2	●
OMHH-2B-120R6.0H	12.0	6.0	12	24	100	2	fig 2	●
OMHH-2B-140R7.0H	14.0	7.0	14	28	150	2	fig 2	●
OMHH-2B-160R8.0H	16.0	8.0	16	32	150	2	fig 2	●
OMHH-2B-200R10.0H	20.0	10.0	20	40	150	2	fig 2	●
OMHH-2B-060R3.0G	6.0	3.0	6	12	100	2	fig 2	●
OMHH-2B-080R4.0G	8.0	4.0	8	16	100	2	fig 2	●
OMHH-2B-100R5.0G	10.0	5.0	10	20	150	2	fig 2	●
OMHH-2B-120R6.0G	12.0	6.0	12	24	150	2	fig 2	●

● Stock available ▲ Make-to-order

Workpiece material (○ suitable, ◎ very suitable)

Carbon steel	Alloy steel	Pre-hardened steel, Hardened steel				Stainless steel	Cast iron, nodular cast iron	copper alloy	Aluminum alloy	titanium alloy	Heat resistant alloy
		~40HRC	~50HRC	~55HRC	~68HRC						
○	○	◎	◎	◎	◎	○	○				

OMHH-2B/2BH/G recommend cutting parameters

Workpiece material	Pre-hardened steel, hardened steel 40-50HRC				Hardened steel 50-60HRC				Hardened steel 60-68HRC			
	Diameter (mm)	Rotating speed (min-1)	Feedspeed (mm/min)	Ap (mm)	Ae (mm)	Rotating speed (min-1)	Feedspeed (mm/min)	Ap (mm)	Ae (mm)	Rotating speed (min-1)	Feedspeed (mm/min)	Ap (mm)
R0.5	40000	1900	0.01	0.05	36000	1500	0.01	0.05	32000	1400	0.01	0.05
R1.0	33000	3100	0.02	0.075	26000	2100	0.02	0.075	24000	2000	0.02	0.075
R1.5	29000	4100	0.03	0.1	23000	2900	0.03	0.1	21000	2600	0.03	0.1
R2.0	22000	3900	0.04	0.15	17000	2500	0.04	0.15	15500	2100	0.04	0.15
R2.5	17500	3500	0.05	0.15	13500	2200	0.05	0.15	13000	2000	0.05	0.15
R3.0	15000	3100	0.06	0.2	11500	1700	0.06	0.2	10500	1500	0.06	0.2
R4.0	11000	2500	0.08	0.25	8600	1600	0.08	0.25	8000	1400	0.08	0.25
R5.0	9000	2000	0.1	0.3	7000	1400	0.1	0.3	6000	1200	0.1	0.3
R6.0	7500	1800	0.1	0.35	5700	1300	0.1	0.35	5300	1200	0.1	0.35
R8.0	5500	1800	0.1	0.4	4300	1300	0.1	0.4	4000	1200	0.1	0.4
R10.0	4500	1800	0.1	0.5	3500	1300	0.1	0.5	3200	1200	0.1	0.5

max. cutting depth

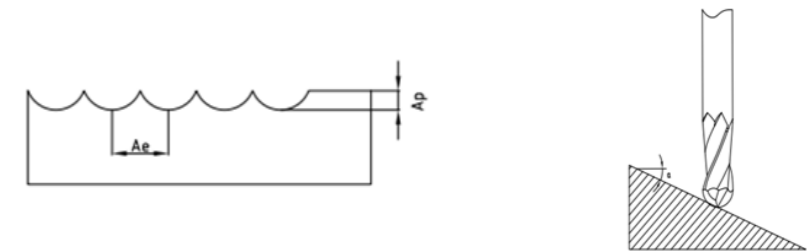

1. Please select high-precision machine and tool holder.
2. When the machine rigidity and workpiece fixture stability is low, vibration and abnormal noise may be generated. Please reduce the rotating speed and feed rate stated above correspondingly.
3. Please use air cooling or MQL (minimum oil mist cooling)
- 4 If inclination angle α over 15° , please reduce the speed to 50%-80% of above table.
- 5 Make overhang of tool as short as possible in conditions of non-interference.



E

Technical Information

E-1	Turning Tools	255-270
E-2	Milling Tools	271-276
E-3	Drilling Tools	277-283
E-4	Application Cases	284-296
E-5	General Technical Guide	297-316

D-1 Technical Information

Turning Tools

Recommend Collocation of General Turning Grades and Chip Breakers

	ISO P Steel	ISO M Stainless Steel	ISO K Cast Iron	ISO S Cast Iron
Finishing	OPF — OC2115	OMF — OP1215 — OP1315		SMM — OP1105
	OTF — OC2115	OTF — OP1215 — OP1315		OP6215
		MSF — OP1215 — OP1315	OKM — OC3210	
Semi Finishing	OPM — OC2125	MF — OP1215 — OP1315	OC3215	
	OC2325	OMM — OC4315 — OP1215	General chip breaker — OC3210	
	OC2325S	OP1315	OC3215	OSM — OP1105
	OTM — OC2125	OTM — OP1215 — OP1315		OP6215
Roughing	OC2325		OKR — OC3215	
	OC2325S		OC3220	
	OPR — OC2125		Fit (None chip breaker) — OC3215	
	OC2325S		OC3220	
	OTR — OC2125			
	OC2325			
	OC2325S			

Recommended Cutting Parameters on Different Grades

ISO	P类 IOS P		
Materials	Carbon steel	Alloy steel	Hardened and tempered steel
Hardness	HB120-180	HB180-240	HB240-350

ISO	IOS M	
Materials	Austenite	Martensite
Hardness	HB120-200	HB330

ISO	IOS K	
Materials	Grey cast Iron	Nodular cast Iron
Hardness	HB150-220	HB140-220

ISO	IOS N
Materials	Aluminium alloy
Hardness	HB60

Recommended Cutting Parameters on Different Grades

Materials \ Grade		OC2015	OC2025	OC2115	OC2125
Carbon steel	Vc(m/min)	450-200	430-180	480-260	460-240
Alloy steel		320-140	300-130	340-150	330-150
Hardened and tempered steel		200-80	190-70	220-80	210-70

Materials \ Grade		OC4015	OC4025	OC4225	OP1205
Austenite	Vc(m/min)	200-100	190-90	210-110	220-100
Martensite		200-140	210-130	220-140	260-170





Materials \ Grade		OC3015	OC3115D	OC3215	
Grey cast Iron	Vc(m/min)	280-160	400-190	380-200	
Nodular cast Iron		280-140	300-150	220-110	

Grade	OK434			
Vc(m/min)	900-400			

Common Problems and Solutions for Turning

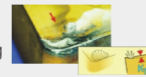
FAQ		Reason	Solutions		Insert Grade		Cutting Conditions				Tool Shape					Setting/ Machine			
			Harder Grade	Tougher Grade	Vc	Fn	Ap	Coolant	Chip Breaker Review	Rake Angle	Corner Radius	Setting Angle	Edge Strength	Change to Higher Tolerance	Toolholder Rigidity	Workpiece/Tool Installation	Overhang Length	Power, Rigidity	
Too Much Wear On Nose	Accuracy Out Tolerance	Wear Increase at Flank Wear	○																
		Unsuitable Cutting Conditions			↓	↑													
Surface Accuracy Deterioration	POOR Roughness Of Surface	Tool weariness Increasing, Cutting Edge not Sharp	○		↓			○		↑	↑		↓	○					
		Cutting Edge Chipping		○		↓	↓			○		↑		↑		○	○	○	
		Unsuitable Geometry								○		↑		↓	○				
		Unsuitable Cutting Conditions				↑	↓	↓	○										
		Vibration, Chattering		○		↑↓	↓	↓	○	○	↑	↓	↑	↓	○	○	○	○	
Heat	Cutting Heat Factors	Unsuitable Cutting Conditions			↓	↓	↓												
		Unsuitable Geometry	○						○	↑			↓						
Deterioration of Accuracy	Variation of Dimension	Unsuitable Insert Accuracy												○					
		Position Offset of Workpiece and Tool								○	↑	↓	↑		○	○	○	○	
Edge Damage	Wear Increase at Relief Face	Flank Wear	○		↓				○	↑	↑		↓						
		Rake Face Wear	○		↓	↓	↓		○	↑		↓							
	Chipping		○		↓	↓		○			↓	↑		○	○	○	○		
	Built-up Edge	Unsuitable Workpiece Hardness and Cutting Conditions			↑	↑		○	○	↑		↓	○						
	Comp Cracks	Unsuited Tool's Material and Cutting Condition to Workpiece Material			↓	↓	↓	○	○	↑		↓							
	Edge Nose Deformation	Interrupted Cutting	○		↑	↓	↓	○	○	↑	↑	↓	↓						
	Tool Life	Unsuited Material and Cutting Condition	○		↓	↓		○		↑	↓	↑		○	○	○	○		
Chip Control	Long, Tangling Chips	Unsuitable Cutting Conditions			↓	↑	↑												
		Unsuitable Material and Cutting Conditions							○		↓	↑							
	Chips Scattering	Unsuitable Cutting Conditions				↓	↓	○											
Burns Turned-down Edge	Steel, Aluminum-Burr	Unsuitable Cutting Conditions			↑	↓		○											
		Insert Wear, Unsuitable Geometry	○						○	↑	↓	↑	↓						
	Iron Cast, Turned-down Edge	Unsuitable Cutting Conditions			↓	↑		○											
		Insert Wear, Unsuitable Geometry	○						○	○	↓	↓	↓						
Soft Steel, Turned-down Edge	Unsuitable Cutting Conditions				↓	↓													
	Insert Wear, Unsuitable Geometry	○						○	↑	↑		↑		○	○	○	○		

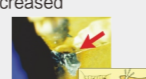
Tool Wear and Solution

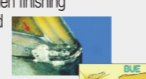
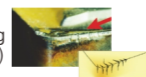
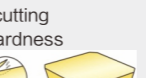
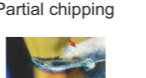
Tool Wear Types	Situation	Reason	Solutions
Flank Wear	Higher cutting resistance Notch wear on flank Poor roughness of surface or deterioration of accuracy. 	Soft grades Excessive cutting speed Small flank angle Low feed	Select a higher wear-resistant grade Reduce cutting speed Increase flank angle Increase feed
Crater Wear	Uncontrolled chip Poor surface quality when finishing High speed processing carbon steel 	Soft grades Excessive cutting speed Excessive feed The strength of chip breaker insufficient	Change to a higher wear-resistant grade Reduce cutting speed Reduce feed Select a higher strength chip breaker
Chipping	Sudden fracture of cutting edge (rake face and flank) Instability insert life 	Toughness insufficient Excessive feed rate Strength of cutting edge insufficient Instability of the tool	Select a tougher grade Decrease feed rate Increase honing of cutting edge (chamfering to rounding) Increase the stability and setting angle
Insert Fracture	Cutting resistance increased Poor surface roughness 	Toughness insufficient Excessive feed rate Strength of cutting edge insufficient Instability of the tool	Select a tougher grade Decrease feed rate Increase honing of cutting edge (chamfering to rounding) Increase the stability and setting angle
Plastic Deformation	Variation of dimension Nose wear, cutting edge drape or passivating when processing alloy steel Poor surface roughness 	Soft grade Excessive cutting speed Excessive cutting depth and feed rate Overheat on cutting edge	Select a higher red hardness cutting material Decrease cutting speed Decrease cutting depth and feed rate Select a higher thermal conductivity cutting material (CVD+sufficient coolant)
Build-Up-Edge	Workpiece dissolve with Cutting edge Poor surface roughness when finishing Cutting resistance increased Cutting soft materials 	Cutting speed too low Cutting edge obtuse Unsuitable tool material	Increase cutting speed Increase rake angle Select small sticking force
Thermal Crack	Crack by heat cycle (often happen in milling and interrupted cutting) 	Toughness of tool grade insufficient Swell and shrink by cutting heat (cold-thermocycling)	Cutting without coolant/Sufficient coolant Select a tougher and more thermal shock resistance grade
Flaking	Often in instability cutting and cutting high-hardness materials 	Build-up edge Uncontrolled chip	Increase rake angle Increase chip breaker
Notch Wear	Notch partial failure Partial cratering 	Processing hardened material, oxide-scale, superalloy	Select a higher wear-resistance CVD grade Adopt taper cutting (variable cutting depth) Decrease setting angle

The Names of Each Part of Turning Tool

Names of Turning Holder Parts

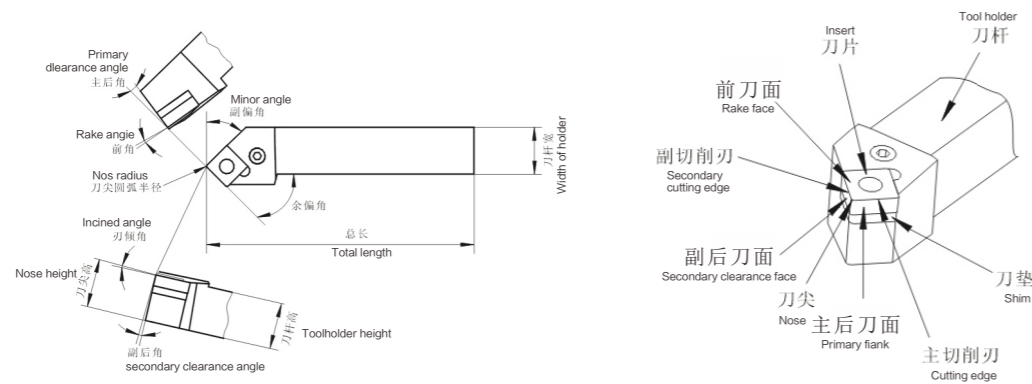

Effects of Rake Angle

Larger rake angle makes cutting edge sharper. reduces resistant forces of chip flow. diminishes friction and prevent deformation. leading to smaller, less abrasion and higher surface quality. However, too large rake angle would reduce the rigidity and strength of tool. Heat can't be diffused easily, Serious breakage and abrasion on tool would occur, reducing tool life. Please choose rake angle according to machining conditions.

Value selection	Situations
Small rake angle	When machining brittle and hard materials: When roughing and interrupted cutting
Big rake angle	When machining Plastic or soft materials: When finishing:

The Names of Each Part of Turning Tool

Effects of Clearance Angle

The main function of clearance angle to reduce the friction between the clearance face of tool and the surface of workpiece. When the rake angle is fixed, larger clearance angle can increase and the achieve higher surface quality. However, if clearance angle is too large, the strength of cutting edge would decrease. Also, heat can't be diffused easily and serious abrious would occur, reducing tool life.

The principle of choosing clearance angle: Choose small clear-ance angle if friction is not serious

Value selection	Situations
Small clearance angle	In order to increase nose strength when roughing When machining brittle and hard materials
Large clearance angle	In order to reduce friction when finishing When machining materials easy to be hardened:

The Names of Each Part of Turning Tool

Effects of Inclined Angle

Positive or negative inclined angle determines the direction of chip flow, and also affects the strength and impact resistance of insert nose.

As diagram(1) shows, when the inclined angle is negative, namely nose is in the lowest point as apposed to eht bottom of tool, chips flow to the machined surface of workpiece.

As diagram(2) shows, when inclined angle is positive, namely the nose is in the highest point as apposed to the bottom of the tool, chips flow to the areas of workpiece surface that haven't been machined.

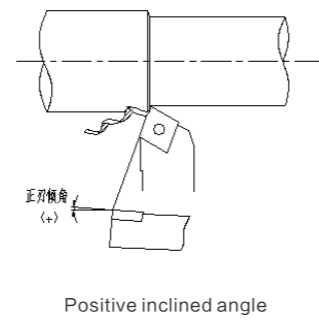
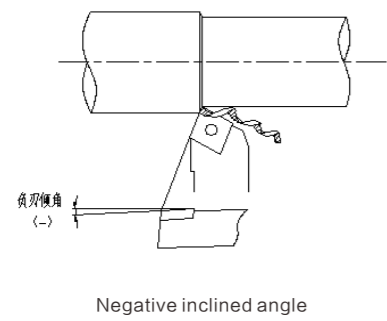

The change of inclined angle also affects insert nose strength and impact resistance. When the inclined angle is negative, the nose is in the lowest point of cutting edge. When the cutting edge enters the workpiece, the contacting point is on the cutting edge or rake face, protecting the nose from impact and increasing the strength of the nose. Normally, negative inclined angle should be chosen for tools with big rake angle. This can not only increase nose strength, but also prevent the impact of entry.

The Names of Each Part of Turning Tool

Effects of Approach Angle

Reduces approaching angle increases the strength of tools and enable heat to diffuse easily, improving surface quality. This is because when the approach angle is small, cutting edge width is large, and then the unit width of cutting edge bears less cutting force. Meanwhile, tool life can be improved.

Normally, select 90° approach angle for turning of slender and step shaft; select 45° approach angle for external turning. End surface machining and chamfering. When approach angle is larger, radial force is reduced, cutting is stable, cutting thickness is increased, and chip breaking is excellent.

Value selection	Situations
Small approach	For those materials with high intensity, high hardness and hardened layer on the surface
Big approach angle	When rigidity of the machine is not enough

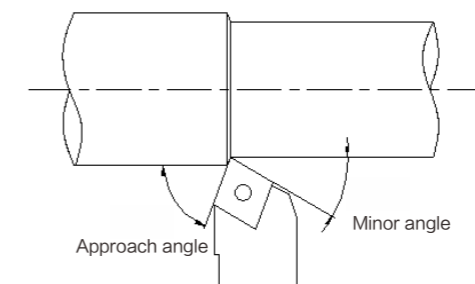

The Names of Each Part of Turning Tool

Effects of Minor Angle

Minor angle is the main angle that can affect surface quality, and it can also affect tool strength. If the approach angle is too small, the friction between the secondary flank and machined surface of workpiece will increase, causing vibration.

The principle of selecting minor angle: Select small minor angle when roughing or when the friction is unaffected and is on vibration. Select large minor angle when finishing.

Nose Radius

Nose radius significantly affects nose strength and surface quality. Large nose radius means higher cutting edge strength, and the abrasion on the rake face and clearance face can be reduced to some extent. However, if the nose radius is too large, radial force will increase, and vibration is easy to occur, affecting machining precision and surface quality.

Value selection	Situations
Small nose radius	Finishing at small cutting depth Machining parts such as slender shaft When the rigidity of the machine is not enough
Large nose radius	When roughing / When machining hard materials (intermittent cutting) When the rigidity of the machine is not enough

Tool Wear and Solution

Calculation of Cutting Speed



$$V_c = \frac{\pi \times D \times n}{1000} (m/min)$$

In the formula: V_c : Cutting speed (m/min)
 n : Rotating speed of main axle (rev/min)
 D : Diameter of workpiece (mm)
 For example: When the rotating speed is 280 rev/min and the diameter of workpiece is 150 mm, the cutting speed should be:

$$V_c = \frac{\pi \times D \times n}{1000} = \frac{3.14 \times 150 \times 280}{1000} = 132 (m/min)$$

Calculation of Feed Rate

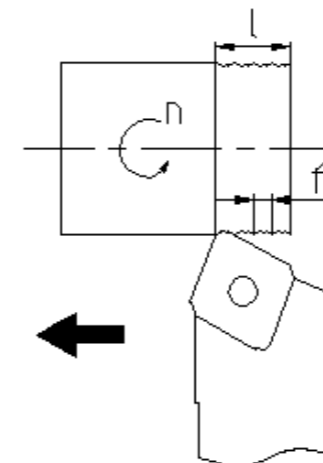

$$f = \frac{l}{n} (mm/rev)$$

In the formula: f : Feed rate per rotation (mm/rev)
 L : Cutting length per minute (mm/min)
 N : Rotating speed of main axle (rev/min)
 For example: When the rotating speed of main axle is 500 rev/min, and the cutting length per minute is 100 mm/min, the feed rate per rotating should be:

$$f = \frac{l}{n} = \frac{100}{500} = 0.2 (mm/rev)$$

Tool Wear and Solution

Cutting Time Calculation of External and Internal Turning



$$T = \frac{l}{f \times n} \text{ (min)}$$

In the formula: T: Cutting time(min)
 L: length of machined areas(mm)
 F: Feed rate(mm/rev)
 N: Rotating speed of main axle(rev/min)
 For example: When the rotating speed of main axle is 250rev/min, and the feed rate is 2.0mm/rev.the time needed for a cutting length of 150mm should be:

$$T = \frac{l}{f \times n} = \frac{150}{0.2 \times 250} = 3 \text{ (min)}$$

Time Calculation End Surface Turning (Constant Linear Speed)

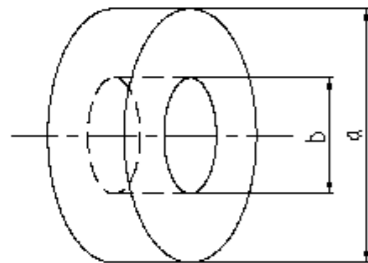

$$T = \frac{\pi \times (a^2 - b^2)}{4000 \times V_c \times f} \text{ (min)}$$

In the formula: T: Cutting time(min)
 Vc: length of machined areas(mm)
 F:Cutting speed
 For end surface without hole, b=0, the formula is still Valid.

Tool Wear and Solution

The Oretical Value Calculation of Machined Surface Roughness

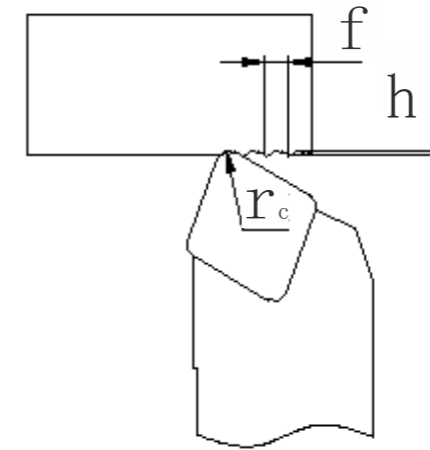

$$R = \frac{f^2}{8r_c} \times 1000 (\mu m)$$

In the formula: R: Theoretical roughness value of machined surface
 F: Feed rate (mm/rev)
 Rc: Nose radius(mm)
 For example: When the feed rate is 0.2mm/rev, and the nose radius is 0.4mm, the theoretical roughness value of machined surface should be:

$$R = \frac{f^2}{8r_c} \times 1000 = \frac{0.2^2}{8 \times 0.4} \times 1000 = 12.5 (\mu m)$$

Tool Wear and Solution

Effects of Three Main Parameters

Normally, short machining time, long tool life and high machining precision are expected in machining, so the material quality, hardness, and shape of the workpiece, and properties of machine should be fully considered and then we can select suitable tools and adopt high-efficiency cutting parameters, namely three parameters.

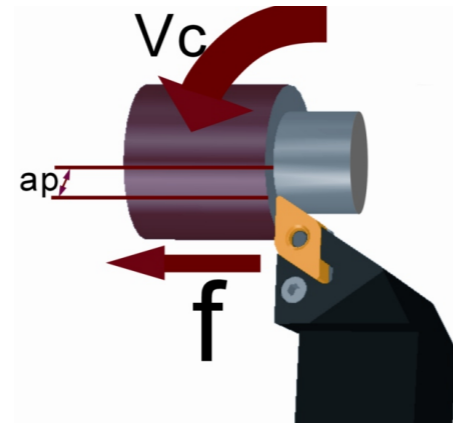

Cutting Speed (Vc)

When the workpiece is rotating on the machine, the number of its rotation per minute is defined as Rotating speed of main axle (n). Because of its rotation, the cutting speed measured on the contacting point of diameter is defined as linear speed. m/min. Normally, linear speed is considered to measure the effect of cutting speed on machining.

Effect of Cutting Speed

Cutting speed has significant effect in tool life. When the cutting speed is increased, cutting temperature will increase and tool life will be shortened. Cutting speed varies according to the different types and hardness of work-piece. The below conclusions are reached after many cutting experiments:

- (1) Normally tool life would be reduced to half when the cutting speed is increased by 20%. Tool life would be 20% of the original life if the cutting speed is raised by 50%.
- (2) Low speed (20-40m/min) cutting could easily cause vibration and shorten tool life.

Tool Wear and Solution

Feed Rate (fn)

Feed rate is defined as the moving distance of tool after workpiece rotates for one circle, measured by mm/rotation.

Feed Rate (fn)

Feed rate is a key factor that determines surface quality. Meanwhile it also affects the range of chip forming and the thickness of chips during machining. In terms of the effect on tool life, small feed rate leads to serious abrasion on clearance face, reducing tool life.

Cutting Depth (ap)

Cutting depth is defined as the difference between machined surface and unmachined surface. Measured by mm. It is half the difference value between the original diameter and machined diameter.

Effect of Cutting Depth

Cutting depth should be determined by the machining allowance and shape of workpiece, power and rigidity of machine, and tool rigidity. The change of cutting depth has little effect on tool life. If the cutting depth is too low, the cutting nose only scrapes the hardened layer on the workpiece surface, reducing tool life. When there is a hardened oxide layer on the workpiece surface, higher cutting depth should be adopted within the possible range of machine's power to avoid cutting nose just cutting the hardened layer of workpiece.

E-2

Technical Information

Milling Tools

Technical Information About Indexable Milling Tools

Difference and Selection Between Down Milling and Up Milling

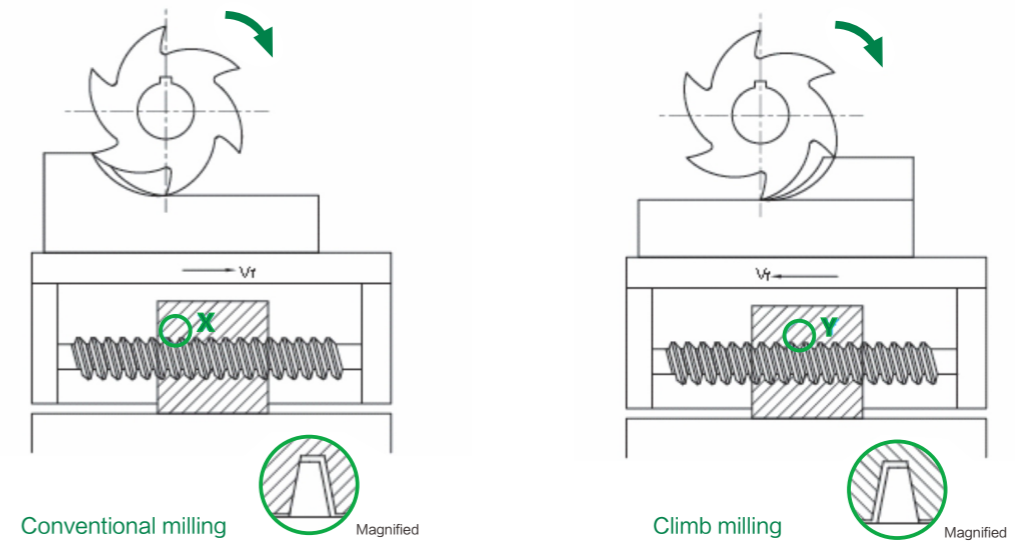

Conventional milling (also called up milling) :the feed direction of workpiece is opposite to that of the milling rotation at the connecting position

Climb milling(also called down milling);the feed direction of workpiece is the same as that of the milling rotation at the connecting position

In down milling,the major force of cutting edge is compressive stress,white in up milling the tensile stress.The compressive strength of cemented carbide material is much larger than its tensile strength.In down milling,as chips become thin from thick gradually,cutting edge and workpiece press against each other.The friction between edge and workpiece is small,thus reducing the abrasion of edge,the hardening of workpiece surface and the surface roughness(Ra).in up milling ,chips become thick from thin gradually.When the insert is cutting into the workpiece,it produces strong friction and more heat than in down milling,and make workpiece surface hardened.



In up milling,because horizontal direction of cutting force milling cutter conducting on workpiece is opposite to the feed direction of workpiece,the lead screw of worktable joints closely with onese side of the screw nut.In down milling,the direction of cutting force is the same as the feed direction.When edge' s radial force on workpiece is large enough,the worktable will bounce left and right,thus make the gap fall behind.The gap will return to the front side with the continuing rotation of lead screw.At this moment the worktable stops motion,however,it will bounce left and right again when the radial cutting force is large enough again.The periodical bounce of worktable will cause poor surface quality of workpiece and tool breakage.

When using end mills for down milling,the edges always starts cutting at the workpiece surface,therefore end mills are not suitable for machining workpiece with hardened surface.

Up milling is recommended for milling thin-wall components or square milling with high requirement for precision.

Pitch Selection

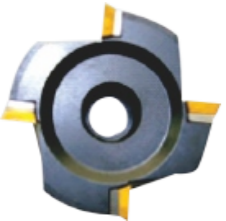
Pitch is the distance between one point on one cutting edge and the same point on the next edge. Milling cutters are mainly classified into coarse, close and extra close pitches.

Optimized stability		
L	M	H
<p>Coarse pitch unequal pitch design</p> 	<p>Close pitch</p> 	<p>Extra close pitch</p> 
<p>When the milling width is equal to diameter of cutter, the machining system is stable and main power of machine is sufficient, the use of coarse pitch can achieve high productive efficiency.</p>	<p>Used in general milling and multiple mixed productions.</p>	<p>When the milling width is less than diameter of cutter, cutting by maximum edges can achieve high productive efficiency.</p>

Selection of Approach Angle

The approach angle is formed by insert and tool body. It affects chip thickness, cutting forces and tool life. Decreasing the approach angle reduces chip thickness and expands the cutting area between cutting edge and workpiece at a given feed rate.

A smaller approach angle also ensures stable entry into or exiting workpiece, protecting the cutting edge and extending tool life. However, this will increase axial cutting forces on the workpiece, thus is not suitable for machining thin workpiece such as thin plate.

Approach angle	Feed rate per tooth	Maximum chip stickiness
90°	f_z	$hex = f_z \times \sin \alpha$
75°	f_z	$hex = 0.96 \times f_z$
60°	f_z	$hex = 0.86 \times f_z$
45°	f_z	$hex = 0.707 \times f_z$
圓刀片	f_z	$hex = \frac{\sqrt{ic^2 \times (ic-2ap)^2}}{ic} \times f_z$

The Names of Each Part of Milling Tools

V_c : cutting speed (m/min)	V_f : feed rate of worktable (feed speed) (mm/min)	D_c : nominal diameter of milling tool (mm)
f_z : feed rate per tooth (mm/z)	n : spindle speed	π : circumference ratio ≈ 3.14
Z_n : number of teeth	T_c : machining time (min)	Q : metal removal rate (cm ³ /min)
f_n : feed rate per revolution (mm/rev)	L : Actual working distance (mm)	

Cutting speed

$$V_c = \frac{\pi \times D_c \times n}{1000} \quad (m/min)$$

Spindle speed

$$n = \frac{1000 \times V_c}{\pi \times D_c} \quad (rev/min)$$

Feed rate of worktable (feed speed)

$$V_f = f_z \times n \times Z_n \quad (mm/min)$$

Feed rate per tooth

$$f_z = \frac{V_f}{n \times Z_n} \quad (mm/z)$$

Feed rate per revolution

$$f_n = \frac{V_f}{n} \quad (mm/rev)$$

Machining time

$$T_c = \frac{L}{V_f} \quad (min)$$

Metal removal rate

$$Q = \frac{ap \times ae \times V_f}{1000} \quad (cm^3/min)$$

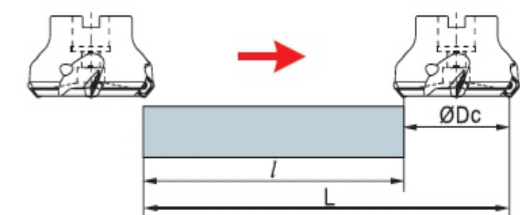
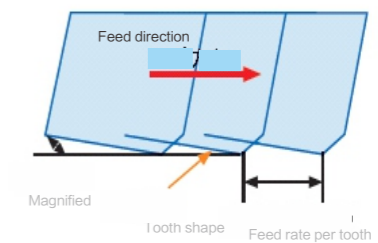
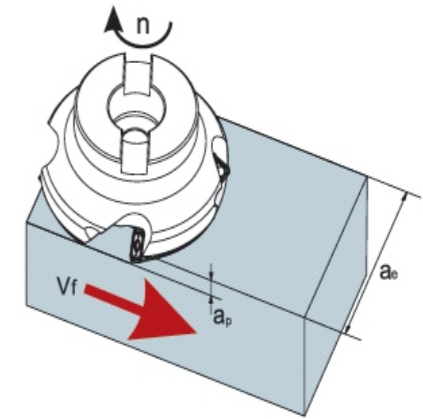

Function of Each Part in Face Milling

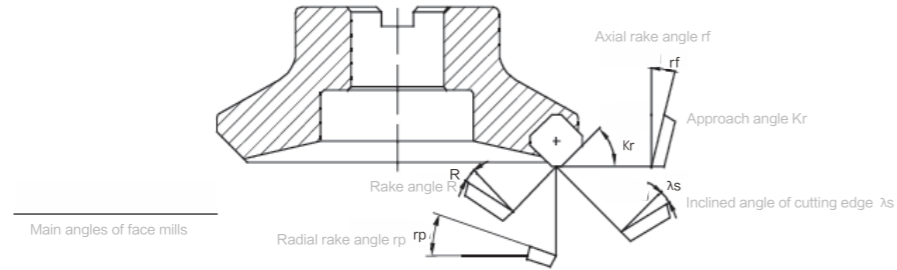

Main Angles of Face Mill

Designation	Function	Effect		
Axial rake angle r_f	Determining the chip direction	Negative, excellent capability of chip removal		
Radial rake angle r_p	Determining whether the cutting is easy and fast or not	Positive angle: good cutting performance		
Approach angle K_r	Determining the chip thickness	$K_r \uparrow$, chip thickness \uparrow ; $K_r \downarrow$ chip thickness \downarrow		
Rake angle R	Determining whether easy and fast the cutting is or not	Poor cutting performance, High-strength cutting edge	$(-) \leftarrow 0 \rightarrow +$	Good cutting performance, Low-strength cutting edge
Inclined angle of cutting edge λ_s	Determining the chip flow direction	Poor capability of chip removal, High-strength cutting edge	$- \leftarrow 0 \rightarrow +$	Good performance of chip removal, Low-strength cutting edge

不同前角的组合特征 Characteristics of Different Rake Angles Combined

		Double positive rake angle	Double negative Rake angle	Positive and negative rake angle
Negative rake angle				
0° rake angle				
Positive rake angle				
	r_f Axial rake angle r_f	+	-	+
	r_p Radial rake angle r_p	+	-	-
Applicable material machined	P	✓		✓
	M	✓		✓
	K		✓	✓
	N	✓		
	S	✓		✓

Selection Method of Cutting Tools

主偏角 approach angle	45°	75°	90°
Schematic diagram			
Instruction	Axial force is the largest, it will bend when machining thin-wall workpiece, reducing the precision of workpiece. It can help avoid fringe breakage of workpiece when machining cast iron	The main force is radial cutting force, in is often used in general face milling	he axial is zero in theory, suitable for milling thin plate workpiece

Selection of Cutting Width and Tool Cutting Diameter in Face Milling

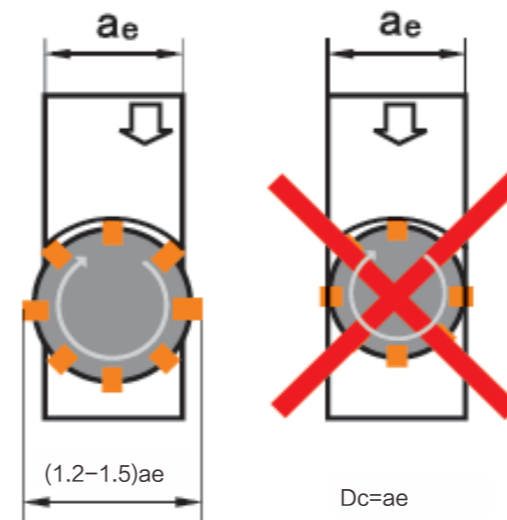

Generally speaking, the relation between cutting width and tool cutting diameter is $D_c = (1.2-1.5)a_e$ in practical machining, same center line of tool center and work piece center should be avoided.

Tool cutting diameter
Cutting width

E-3

Technical Information

Drilling Tools

Drilling Application

initial Drill Penetration

Initial drill penetration is an important factor for successful drilling. one way of ensuring good hole quality is to make sure the penetration surface of the workpiece is vertical to the drill centre axis.

In addition, an indexable drill can carry out initial penetration of convex, concave, inclined and irregular surfaces by adjusting rates.

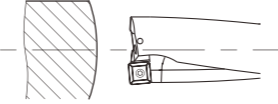
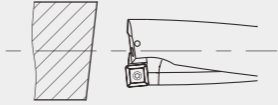
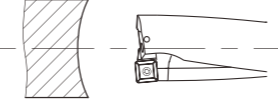
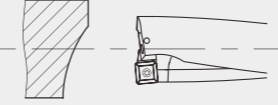
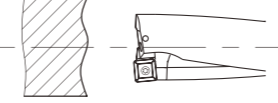
workpiece surface	countermeasures
	<p>For a convex surface, the conditions are relatively good and the centre of the drill ideally makes contact with the workpiece first, thus normal feed can be adopted.</p>
	<p>When penetrating an inclined surface, the cutting edges will be unevenly loaded, which may result in the premature drill abrasion. if the angle of the inclined surface is larger than 2°, the feed should be reduced to 1/3 of the value recommended for the drill.</p>
	<p>When drilling into non-symmetric curved surface, the drill tends to deviate from the centre because it is penetrating an inclined surface. the feed should be reduced to lower than the value recommended for the initial penetration of concave surface.</p>
	<p>When drilling into irregular surface, the insert faces the risk of chipping, which may also occur when drilling through the workpiece. therefore, the feed rate should be reduced. reduced to lower than the value recommended for the initial penetration of concave surface.</p>
	<p>When drilling into irregular surface, the insert faces the risk of chipping, which may also occur when drilling through the workpiece. therefore, the feed rate should be reduced</p>

Calculations for Shallow Drilling

Cutting Speed

$$V_c = \frac{D_c \times \pi \times n}{1000}$$

V_c (m/min):cutting speed
 D_c (mm):drill diameter
 n (rev/min):rotating speed

实例:

Spindle speed is 1600rev/min, drill diameter is 20mm, thus cutting speed is:

$$V_c = \frac{D_c \times \pi \times n}{1000} = \frac{20 \times 3.14 \times 1600}{1000} = 100 \text{ (m/min)}$$

Machining Time

$$T_c = \frac{D_c \times \pi \times n}{1000 \times fr}$$

T_c (min):machining time
 fr (mm/rev):feed rate per revolution
 i :umber of holes l_d (mm):drilling depth
 n (rev/min):spindle speed

实例:

Drilling a hole with a diameter of 20mm and a depth of 40mm, cutting speed is 100m/min and feed rate per revolution is 0.1mm/rev. Calculate the drilling time.

$$n = \frac{V_c \times 1000}{D_c \times \pi} = \frac{100 \times 1000}{20 \times 3.14} = 1600 \text{ (rev/min)}$$

$$T_c = \frac{l_d \times i}{n \times fr} = \frac{40 \times 1}{1600 \times 0.1} = 0.25 \text{ (min)}$$

Feed Speed

$$V_f = fr \times n \text{ (mm/min)}$$

V_f (mm/min):feed speed
 fr (mm/rev):feed rate per revolution
 n (rev/min):spindle speed

实例:

Example:spindle speed is 1500 rev/min, feed rate per revolution is 0.1 mm/rev, thus feed speed is:

$$V_f = fr \times n = 0.1 \times 1500 = 150 \text{ (mm/min)}$$

Metal Removal Rate

$$Q = \frac{V_f \times \pi \times D_c^2}{4 \times 1000}$$

Q (cm³/min):metal removal rate
 D_c (mm):drill diameter
 V_f (mm/min):feed speed

实例:

Example:drill diameter is 20mm, feed speed is 160mm/rev, thus metal removal rate is:

$$Q = \frac{V_f \times \pi \times D_c^2}{4 \times 1000} = \frac{160 \times 3.14 \times 20^2}{4 \times 1000} = 50.24 \text{ (cm}^3\text{/min)}$$

Common Problems and Solutions for Drilling

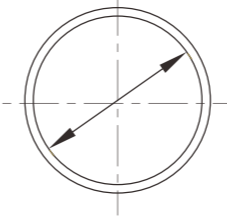
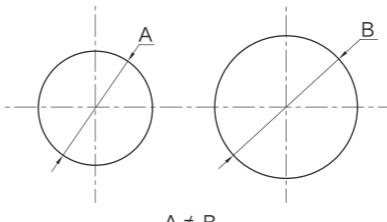
Problem	Cause	Solution
Oversize holes 	Poor clamping Large run-out around spindle	Select the holder and chuch with high Precision calibrating spindle Check and adjust after clamping drill
	Non-symmetric point angle Large run-out Chisel edge is off center	Regrind drill Check the precision after clamping drill
Irregular hole size 	Non-symmetric point angle Large run-out Chisel edge is off center Excessive margin abrasion	Select the holder and chuch with high Precision Calibrating spindle Check and adjust after clamping drill
	Poor clamping Large run-out around spindle Workpiece is not firmly held	Select the holder and chuch with high Precision Calibrating spindle Check and adjust after clamping drill
	Feed rate is too high	Reduce the feed speed
	Coolant provide is not enough	Change the coolant supply method, Or increase coolant volume

Common Problems and Solutions for Drilling

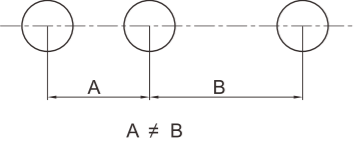
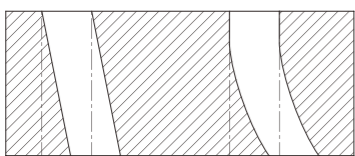
Problem	Cause	Solution
<p>Low position accuracy</p> 	Poor re-positioning of spindle Poor clamping Large run-out around spindle	Improve the re-positioning precision of Machine select the holder and chuch With high precision Calibrating spindle Check and adjust after clamping drill
	The feed direction is not Vertical to the workpiece Surface	Adjust the feed direction vertical to The workpiece
	Top center not align with the Spindle center	Check and adjust alignment carefully Before drilling
<p>Bad linearity bad perpendicularity</p> 	Excessive margin abrasion	Regrind
	Poor center hole accuracy	Increase the position accuracy of hole
	Non-symmetric point angle Large run-out Chisel edge is off center	Regrind drill Check the precision after regrinding
	Insufficient drill rigidity	Increase drill rigidity
	Uneven workpiece rigidity Top center not align with the Spindle center (lathe)	The workpiece must be horizontal or Premachined to horizontal before drilling Pre-drill a center hole

Common Problems and Solutions for Drilling

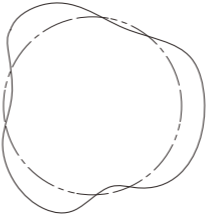
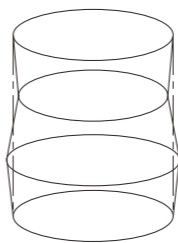
Problem	Cause	Solution
<p>Poor roundness</p> 	Non-symmetric point angle Large run-out Chisel edge is off center	Regrind drill Check the precision after regrinding
	Poor clamping Large run-out around spindle Workpiece is not firmly held	Select the holder and chuch with high Precision calibrating spindle check run Out and adjust after clamping drill
	Clearance angle is too large	Regrind drill
	Insufficient drill rigidity	Increase drill rigidity
<p>Poor workpiece surface quality</p>	Incorrect regrinding	Regrind calibration
	Insufficient coolant or Unsuitable coolant type	Change the coolant supply method, Or increase coolant volume
	Poor clamping Large run-out around spindle	Select the holder and chuch with high Precision calibrating spindle
	Feed rate is too high	Decrease the feed rate
	Excessive abrasion on Cuttingedge Excessive build-up on margin	Regrind drill Select a coated drill
Chip jamming	Select a suitable drill(considering flute Geometry, helical angle etc)change the Cutting method (adjust feed rate, use Step feed etc.)	
<p>Poor cylindricity</p> 	Non-symmetric point angle Large run-out Chisel edge is off center Excessive margin abrasion	Regrind drill Check the precision after regrinding
	Feed rate is too low	Increase the feed speed

Shallow Drilling Recommend Cutting Parameter Chart

ISO	Material	HB	mm	mm/r	m/min
P	Carbon steel	80-200	16.0-23.0	0.05-0.09	200(170-240)
			24.0-30.0	0.05-0.09	
			31.0-38.0	0.06-0.10	
			39.0-46.0	0.07-0.11	
P	Low alloy steel	150-260	16.0-23.0	0.05-0.09	170(140-220)
			24.0-30.0	0.05-0.12	
			31.0-38.0	0.06-0.14	
			39.0-46.0	0.08-0.16	
P	High alloy steel	150-320	16.0-23.0	0.05-0.09	150(120-180)
			24.0-30.0	0.05-0.12	
			31.0-38.0	0.06-0.16	
			39.0-46.0	0.08-0.18	
P	Cast steel	180-250	16.0-23.0	0.05-0.08	140(120-170)
			24.0-30.0	0.05-0.08	
			31.0-38.0	0.06-0.10	
			39.0-46.0	0.07-0.11	
M	Stainless steel Ferritic stainless steel Martensitic stainless steel	150-270	16.0-23.0	0.05-0.09	160(110-230)
			24.0-30.0	0.05-0.12	
			31.0-38.0	0.06-0.16	
			39.0-46.0	0.08-0.18	
M	Austenitic stainless steel	150-275	16.0-23.0	0.05-0.09	140(110-220)
			24.0-30.0	0.05-0.11	
			31.0-38.0	0.06-0.13	
			39.0-46.0	0.08-0.14	
K	Malleable cast iron	150-230	16.0-23.0	0.05-0.10	160(120-220)
			24.0-30.0	0.05-0.14	
			31.0-38.0	0.08-0.16	
			39.0-46.0	0.10-0.20	
K	Grey cast iron	150-220	16.0-23.0	0.05-0.10	200(170-240)
			24.0-30.0	0.05-0.14	
			31.0-38.0	0.08-0.16	
			39.0-46.0	0.10-0.20	
K	Nodular cast iron	160-250	16.0-23.0	0.05-0.09	160(130-200)
			24.0-30.0	0.05-0.12	
			31.0-38.0	0.06-0.14	
			39.0-46.0	0.08-0.16	
N	Aluminium alloy	60-110	16.0-23.0	0.05-0.10	300(250-350)
			24.0-30.0	0.05-0.14	
			31.0-38.0	0.08-0.16	
			39.0-46.0	0.10-0.20	
N			47.0-58.0	0.12-0.24	

E-4 Technical Information

Application Cases

Stainless Steel Cutting Application Cases

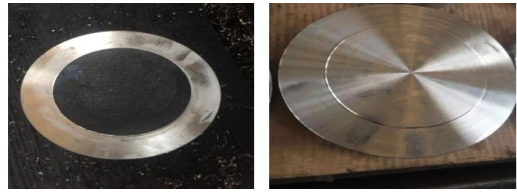

Stainless steel flange

Customer: XX Company
 Workpiece: Stainless steel flange(no hole)
 Workpiece material: 304L
 Lathe type: CSK50A
 OKE insert: CNMG120412-MF/OP1215
 Compare insert: A well-known manufacturer
 Cooling type: Fluid cooling
 Processing content: End face rough turning
 Cutting parameter: $V_c = 180 \text{ m/min}$, $F_n = 0.28 \text{ mm/r}$, $A_p = 2.2 \text{ mm}$

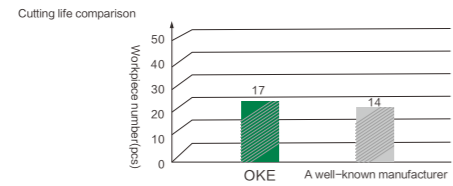

Stainless Steel Cutting Application Cases



Stainless steel flange

Customer: XX Company
 Workpiece: Hubbed flange
 Workpiece material: SUS304L
 Lathe type: HTC1635i
 OKE insert: WNMG060412-OMM/OP1215
 Compare insert: A well-known manufacturer
 Cooling type: Fluid cooling
 Processing content: Taper, end face(semi-finishing)
 Cutting parameter: $V_c = 160 \text{ m/min}$, $F_n = 0.18 \text{ mm/r}$, $A_p = 1.5 \text{ mm}$

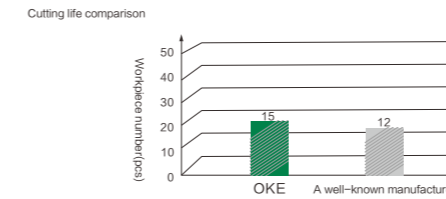

Stainless steel flange

Customer: XX Company
 Workpiece: Flange
 Workpiece material: SUS304
 Lathe type: HTC1635i
 OKE insert: WNMG060412-MSF/OP1315
 Compare insert: A well-known manufacturer
 Cooling type: Fluid cooling
 Processing content: End face fine finishing
 Cutting parameter: $V_c = 200 \text{ m/min}$, $F_n = 0.28 \text{ mm/r}$, $A_p = 0.6 \text{ mm}$

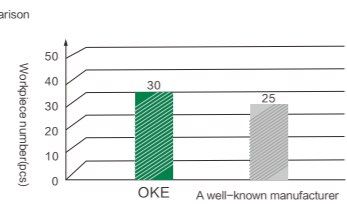

Stainless steel flange

Customer: XX Company
 Workpiece: Flange
 Workpiece material: 45#Forge piece
 Lathe type: CNC lathe
 OKE insert: WNMG080412-OMM/OP1215
 Compare insert: A well-known manufacturer
 Cooling type: No
 Processing content: End face turning
 Cutting parameter: $V_c = 258 \text{ m/min}$, $F_n = 0.2 \text{ mm/r}$, $A_p = 1.25 \text{ mm}$

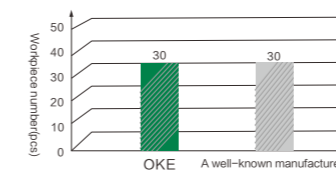

Stainless Steel Cutting Application Cases



Cutting life comparison

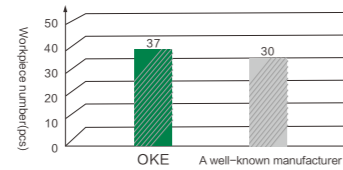

Stainless steel flange

Customer: XX Company
Workpiece: Flange
Workpiece material: SUS316
Lathe type: CNC lathe
OKE insert: WNMG060412-MF/OC4315
Compare insert: A well-known manufacturer
Cooling type: Cooling liquid
Processing content: End face rough turning, remove black skin
Cutting parameter: $V_c=200$ m/min, $F_n=0.28-0.33$ mm/r, $A_p=0.2-0.8$ mm

Steel Cutting Application Cases



Cutting life comparison

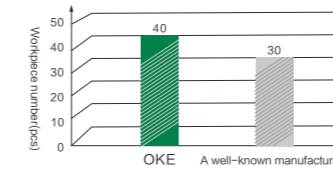

Steel

Customer: XX Company
Workpiece: Hub Bearing Unit(outer ring)
Workpiece material: 55# forge steel
Lathe type: CY-K800H
OKE insert: WNMG080412-OPM/OC2125
Compare insert: A well-known manufacturer
Cooling type: No
Processing content: End face and external rough turning
Cutting parameter: $V_c=260$ m/min, $F_n=0.28$ mm/r, $A_p=1.3$ mm

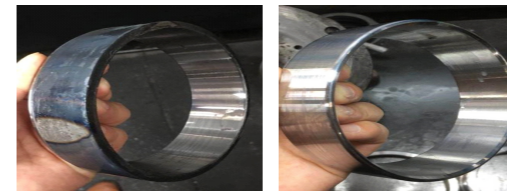

Cutting life comparison

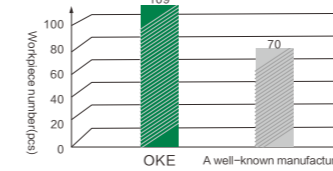

Steel

Customer: XX Company
Workpiece: Bearing outer ring
Workpiece material: Gcr15
Lathe type: SK50P
OKE insert: WNMG080412-Z/OC2325
Compare insert: A well-known manufacturer
Cooling type: Fluid cooling
Processing content: External semi-finishing turning
Cutting parameter: $V_c=393$ m/min, $F_n=0.176$ mm/r, $A_p=1.0$ mm

Steel Cutting Application Cases

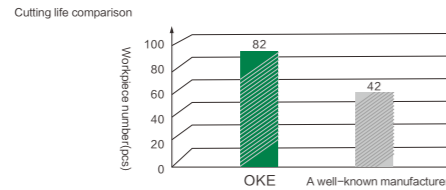

Steel
Customer: XX Company
Workpiece: Bearing outer ring
Workpiece material: Gcr15
Lathe type: SK50P
OKE insert: WNMG080408-Z/OC2325
Compare insert: A well-known manufacturer
Cooling type: Fluid cooling
Processing content: External finishing turning
Cutting parameter: $V_c = 340 \text{ m/min}$, $F_n = 0.18 \text{ mm/r}$, $A_p = 0.5 \text{ mm}$

Steel Cutting Application Cases

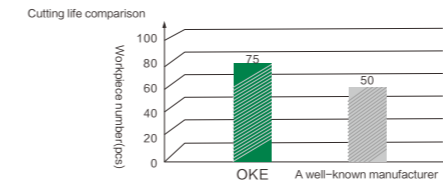

Steel
Customer: XX Company
Workpiece: Cross bearing
Workpiece material: 55# forge steel
Lathe type: Horizontal CNC lathe
OKE insert: WNMG080408-OPM/OC2125
Compare insert: A well-known manufacturer
Cooling type: Emulsion fluid cooling
Processing content: End face, external
Cutting parameter: $V_c = 79 \text{ m/min}$, $F_n = 0.4 \text{ mm/r}$, $A_p = 1.25 \text{ mm}$

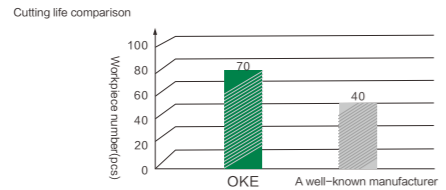

Steel
Customer: XX Company
Workpiece: Outer bearing
Workpiece material: 65# forge steel
Lathe type: Horizontal CNC lathe
OKE insert: WNMG080412-OPM/OC2125
Compare insert: A well-known manufacturer
Cooling type: No
Processing content: End face, and external
Cutting parameter: $V_c = 160\text{--}220 \text{ m/min}$, $F_n = 0.2\text{--}0.28 \text{ mm/r}$, $A_p = 1.0 \text{ mm}$

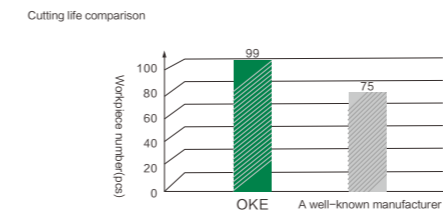
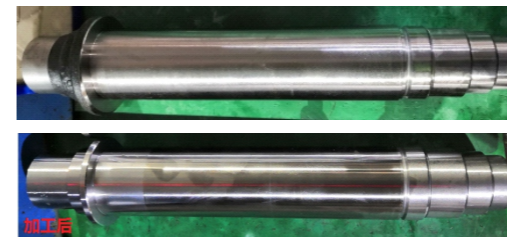

Steel
Customer: XX Company
Workpiece: Spindle
Workpiece material: 20CrMoH
Lathe type: Horizontal CNC lathe
OKE insert: TNMG160408-OPR/OC2115
Compare insert: A well-known manufacturer
Cooling type: No
Processing content: External roughing turning
Cutting parameter: $V_c = 138\text{--}218 \text{ m/min}$, $F_n = 0.24\text{--}0.36 \text{ mm/r}$, $A_p = 1 \text{ mm}$

Steel Cutting Application Cases

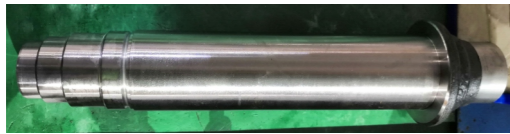
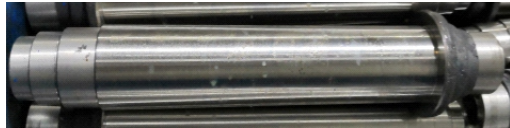

Steel

Customer: XX Company
Workpiece: Spindle
Workpiece material: 20CrMoH
Lathe type: Horizontal CNC lathe
OKE insert: VNMG160404-OPF/OC2115
Compare insert: A well-known manufacturer
Cooling type: No
Processing content: External roughing turning
Cutting parameter: $V_c = 132\text{--}181\text{ m/min}$, $F_n = 0.12\text{--}0.24\text{ mm/r}$, $A_p = 0.5\text{ mm}$

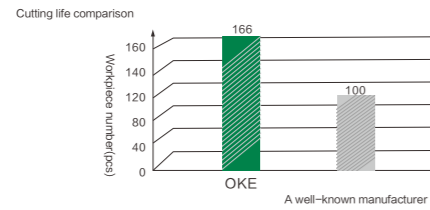

Steel

Customer: XX Company
Workpiece: The outer cylinder
Workpiece material: 30CrMnSi
Lathe type: Horizontal CNC lathe
OKE insert: CNMG160608-OPM/OC2125
Compare insert: A well-known manufacturer
Cooling type: No
Processing content: External roughing turning
Cutting parameter: $V_c = 138\text{ m/min}$, $F_n = 0.4\text{ mm/r}$, $A_p = 3\text{ mm}$

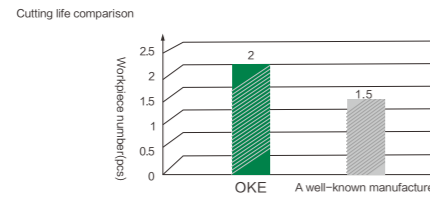

Cast iron Cutting Application Cases

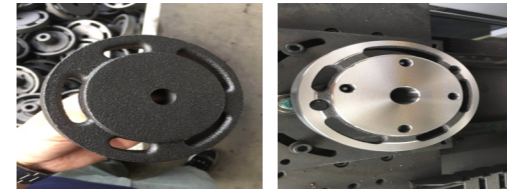

Cast iron

Customer: XX Company
Workpiece: Air Compressor Flange
Workpiece material: HT250
Lathe type: SK50P
OKE insert: WNMG080412/OC3215
Compare insert: A well-known manufacturer
Cooling type: No
Processing content: External and end face roughing turning
Cutting parameter: $V_c = 550\text{ m/min}$, $F_n = 0.35\text{ mm/r}$, $A_p = 1.2\text{ mm}$

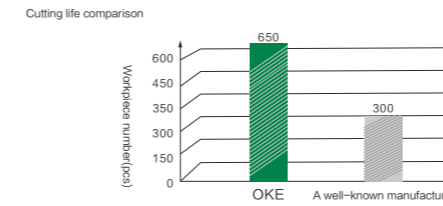

Cast iron

Customer: XX Company
Workpiece: Brake disc
Workpiece material: G3000
Lathe type: i5T3
OKE insert: TNMG220416-GH/OC3215
Compare insert: A well-known manufacturer
Cooling type: No
Processing content: End face semi-finishing turning
Cutting parameter: $V_c = 706\text{ m/min}$, $F_n = 0.32\text{ mm/r}$, $A_p = 1.0\text{ mm}$

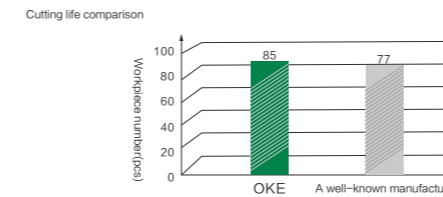

Cast iron Cutting Application Cases

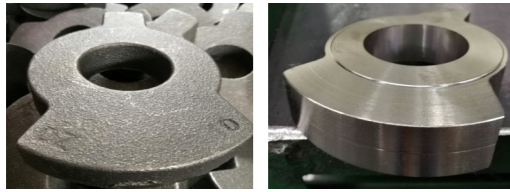

Cast iron

Customer: XX Company
Workpiece: Air compressor flange
Workpiece material: HT250
Lathe type: Horizontal CNC lathe
OKE insert: WNMG080412/OC3215
Compare insert: A well-known manufacturer
Cooling type: No
Processing content: External and end face turning
Cutting parameter: $V_c = 356 \text{ m/min}$, $F_n = 0.28 \text{ mm/r}$, $A_p = 1 \text{ mm}$

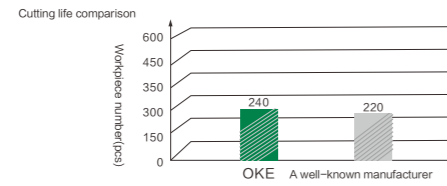

Cast iron

Customer: XX Company
Workpiece: Brake drum
Workpiece material: HT250
Lathe type: Horizontal CNC lathe
OKE insert: WNMG080408/OC3215
Compare insert: A well-known manufacturer
Cooling type: No
Processing content: Endface and external rough turning
Cutting parameter: $V_c = 230\text{--}290 \text{ m/min}$, $F_n = 0.3\text{--}0.45 \text{ mm/r}$, $A_p = 2\text{--}3 \text{ mm}$

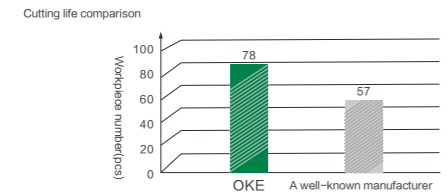

Milling Application Cases



Milling

Customer: XX Company
Workpiece: Turbine blade
Workpiece material: 22Cr12NiWMoV-5
Lathe type: HSTM-500-HD
OKE insert: APKT170516R-QG/OP1312
Compare insert: A well-known manufacturer
Cooling type: Fluid cooling
Processing content: Profile Milling
Cutting parameter: $V_c = 241 \text{ m/min}$, $V_f = 3500 \text{ mm/min}$, $A_p = 1.2 \text{ mm}$, $A_e = 16 \text{ mm}$

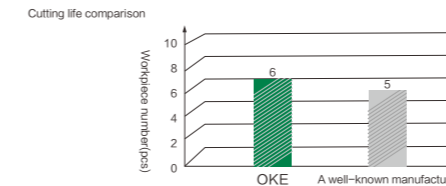

Milling

Customer: XX Company
Workpiece: Gimbal Joint
Workpiece material: 30CrMnSiNi2A
Lathe type: V1850
OKE insert: APMT1135PDER-M2/OP1130
Compare insert: A well-known manufacturer
Cooling type: Fluid cooling
Processing content: Finishing face milling and profile milling
Cutting parameter: $V_c = 120 \text{ m/min}$, $V_f = 3500 \text{ mm/min}$, $A_p = 0.18 \text{ mm}$, $A_e = 2 \text{ mm}$

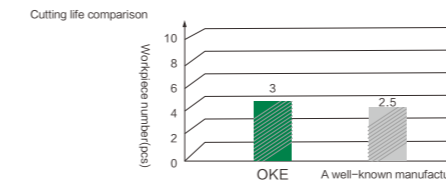

Milling Application Cases

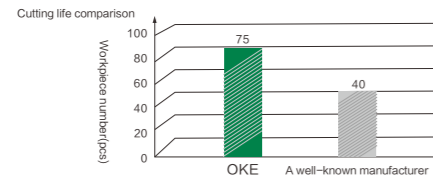

Milling

Customer: XX Company
Workpiece: Side panel mold
Workpiece material: 45#
Lathe type: CNC gantry milling
OKE insert: APMT1604PDER-H2L/OP1215
Compare insert: A well-known manufacturer
Cooling type: Compressed air
Processing content: U-groove, square groove machining, parting
Cutting parameter: $V_c = 94 \text{ m/min}$, $F_n = 1.04 \text{ mm/r}$, $A_p = 0.3\text{--}0.35 \text{ mm}$

Threading Application Cases

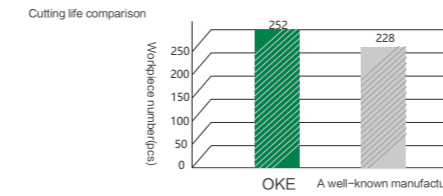

Thread

Customer: XX Company
Workpiece: Joint
Processing industry: Valve
Workpiece material: SUS201
Lathe type: Wenzhou Eastsea CNC
OKE insert: RT1601L-11WA/OP1205
Compare insert: A well-known manufacturer
Processing content: Internal threading turning
criterion of changing tool: Insert wear
Cutting fluid: Yes
Cutting parameter: $V_c = 75\text{--}83 \text{ m/min}$ $F_n = 2.309 \text{ mm/r}$

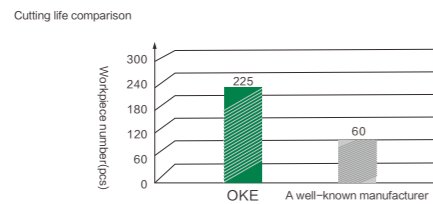
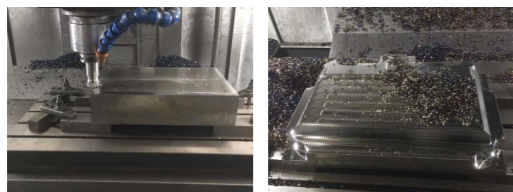

Milling

Customer: XX Company
Workpiece: Side panel mold
Workpiece material: 45#
Lathe type: CNC gantry milling
OKE insert: RPMT1204MO-JSL/OP1315
Compare insert: A well-known manufacturer
Cooling type: Compressed air
Processing content: U-groove, square groove machining, parting
Cutting parameter: $V_c = 138 \text{ m/min}$, $F_n = 0.96 \text{ mm/r}$, $A_p = 0.45 \text{ mm}$

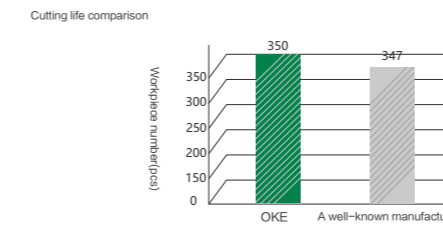

Thread

Customer: XX Company
Workpiece: Elbow
Machining Industry: Valve
Workpiece material: 304
Lathe type: KIND
OKE insert: RT1601L-14WA/OP1205
Compare insert: A well-known manufacturer
Processing content: Internal threading turning
criterion of changing tool: Insert wear
Cutting fluid: Yes
Cutting parameter: $V_c = 58\text{--}65 \text{ m/min}$ $F_n = 1.814 \text{ mm/r}$

E-5

Technical Information

General Technical Reference

Selection Method of Cutting Tool

Selection Method of General Turning Tools:

- 1.Understand the processed material condition,Machine Model and condition.
- 2.Select the suitable insert shape,setting angle and clamoins designation.
- 3.According to above conditions select details of tools as L/R,dimension,etc.
- 4.Select the type,chip break and grade of insert according to all conditions.

Selection Method of Parting and Grooving tools:

- 1.Understand the processed material condition,Machine Model and condition.
- 2.Select the insert type according to processing methods(external,internal,face grooving)
- 3.According to above conditions select details of tools as L/R, dimensions,etc.
- 4.Select the type,clamping designation,chip break and grade of insert according to all conditions

Selection Method of Threading Tools:

- 1.Understand the processed material condition,Machine Model and condition.
- 2.Select the tool type according to thread's type,processing methods,etc.
- 3.According to above conditions select details of cutting tools as L/R,dimension,etc.
- 4.Select the type,chip break and grade of Insert according to all condition

Selection Method of Cutting Tool

Selection Method of Milling Tool Specifications:

1. The first step is to understand the material condition, machine type and state you need to process.
2. Determine the basic type of milling tool according to the processing method(plane milling, Square shoulder milling, imitation milling, milling slot, corner milling, etc.).
3. According to the machining precision and the shape and size of the machining surface and other factors to determine the use of the overall milling cutter or transposable milling cutter.
4. According to the above factors and your machine model to determine the interface, dimensions and other details of the tool.
5. Finally determine the blade specification, groove type, and brand number corresponding to the above factors.

Selection Method for Hole Processing Tool Specifications:

1. Understand the material condition, machine type and state you need to process.
2. Determine the basic types of hole cutting tools(drilling, boring, hinge, thread processing, etc.) according to the processing process.
3. According to the machining accuracy and the dimension of the machining hole, it is determined that the whole tool or the fork-turning tool is used.
4. According to the above factors and your machine model to determine the interface, dimensions and other details of the tool.
5. Finally determine the insert specification, groove type, and brand number corresponding to the above factors.

The Correction Coefficient Table Of Hardness and Cutting Speed

Material	Theoretical Hardness	The Correction Coefficient Table Of Hardness and Cutting Speed									
		Hardness Decrease ← Hardness Difference(Measured Difference - Theoretical Difference) → Hardness Increase									
		-60	-40	-20	0	20	40	60	80	100	
P	HB180	1.42	1.24	1.11	1.00	0.91	0.84	0.77	0.72	0.67	
M	HB180	1.44	1.25	1.11	1.00	0.91	0.84	0.78	0.73	0.68	
K	Grey Cast Iron	HB220	1.21	1.13	1.06	1.00	0.95	0.9	0.86	0.82	0.79
	Nodular Cast Iron	HB250	1.33	1.21	1.09	1.00	0.91	0.84	0.75	0.7	0.65
N	HB75			1.05	1.00	0.95					
S	HB350			1.12	1.00	0.89					
HRC			-6	-3	0.00	3	6	9			
H	HRC60		1.10	1.02	1.00	0.96	0.93	0.9			

Actual Processing Speed=Recommended Processing Speed*Correction Factor Of Cutting Speed

Recommended Cutting Parameters See Packaging

i.e. Cutting general alloy steel, hardness HB180, CNMG120404-OPF/OC2015, the recommended cutting speed is $V=250\text{m/min}$. When measured hardness is HB220, the hardness difference is 40(220-180). Find The corresponding speed correction coefficient is 0.84 on above table, and then the actual processing speed $V_c=250*0.84=210\text{mm/min}$

The Correction Coefficient Table Of Insert Life and Cutting Speed

Insert Life Insert Material	The Correction Coefficient Table Of Insert Life and Cutting Speed					
	10	15	30	45	60	90
OC2015	1.12	1.00	0.82	0.73	0.67	0.6
OC2025	1.11	1.00	0.84	0.76	0.71	0.64
OC2035	1.11	1.00	0.84	0.76	0.70	0.63
OC2115	1.25	1.00	0.68	0.54	0.46	0.37
OC2125	1.55	1.00	0.47	0.30	0.22	0.14
OP1205	1.15	1.00	0.82	0.74	0.69	0.64
OP1215	1.10	1.00	0.85	0.72	0.65	0.62
OP1030	1.10	1.00	0.85	0.72	0.65	0.62
OC4025	1.19	1.00	0.75	0.63	0.56	0.47
OC4315	1.22	1.00	0.73	0.61	0.54	0.45
OC3105	1.11	1.00	0.70	0.60	0.50	0.40
OC3215	1.22	1.00	0.80	0.65	0.60	0.55
OC3115D	1.25	1.00	0.72	0.63	0.52	0.41
OP2202	1.20	1.00	0.84	0.70	0.63	0.59

Actual Processing Speed=Recommended Processing Speed*Correction Factor Of Cutting Speed

i.e. Cutting general alloy steel, CNMG120404-OPF/OC2015, the recommended cutting speed is V=250m/min (the standard life is 15 min). If the insert life of 60 mins is expected, find the speed correction coefficient is 0.67 on above table, and then the actual processing speed is Vc=250*0.67=167.5m/min.

Comparison Table for Turning Insert Chipbreaker

Negative Inserts

ISO	Processing Category	OKE	TaeguTec	KENNAMETAL	HITACHI	ZCCCT	SANDVIK	TUNGALOY	KYOCERA	KORLOY	SUMITOMO	mitsubishi
P	Superfinishing	R/L-F	FA	FF	FE		QF,LC	01, F	DP,GP,PP, VF,XP, XP-T,XF	VL	FA,FB, FL	PK,FH,FP, FY,FS
	Finishing	OPF 53 Z	FG,FA	FN	BE, B, CE, BH	DF	XF,PF,	TS,TSF,ZF 11,NS,AS, TQ,NM,CS	DP,GP,PP	VF,VB	SU, LU, FE	LP,C, SA, SH
	Finishing(Soft Steel)	OPF	FC	FN		SF		17,TS,NS,CB 11, 27, ZF	XQ,XS	VL	FL	SY
	Finishing(Wiper)		WS	FW		WGF	WL,WF	AFW,FW, ASW,SW	WF,WP	HW	LUW,SEW	SW
	Semifinishing	OPM KPM	MP,MC, PC,MT	MN	CT,AB, AH,AY,AE	DM,PM	PM,QM, XM	TM,AM,DM, ZM,TA	PG,GS,PS	VM,MP	GU (UG) UX, GE	MP,MA
	Light Roughing	OPR	RT,通槽	RN,RP	RE, Y	DR LR	PR,HM XMR	TH,THS	PH	B25,HR, GR	MU, MX, UX	GH,RP, 通槽
	Roughing	OPR OPH	RX,RH,HD, HT,HY,HZ	MR, RN, RP	TE,UE,HX, HE,H	DR HDR	QR,MR PR,HR	TI,TRS, TUS	PX	GH,VH, VT	HG,HP,HU, HW,HF	HZ, HL,HM, HX,HR,HV

Comparison Table for Turning Insert Chipbreaker

Negative Inserts

ISO	Processing Category	OKE	TaeguTec	KENAMETAL	HITACHI	ZCCCT	SANDVIK	TUNGALOY	KYOCERA	KORLOY	SUMITOMO	mitsubishi
M	Finishing	OMF MSF	EA,SF	FP,FF	MP,AB,BH	EF	MF	SF,SA,SS	MQ,SQ	VP2,MP	SU,EF	SH,LM
	Semifinishing	OMM MF	ET,EM	MP,UP	PV,DE,SE,AH	EM	MM,QM, XM,K	SM,S,TA	MU,MS, TK,SX	HS,MM	EX,EG,GU	MS,GM, MM,MA,ES
	Roughing	OMR		MR,RP,P	AE	ER	MR	TH,SH,TU		GA,RM	HM,EM,MU	GH, HZ, RM,HL,HZ
K	Finishing	OKM	MT	FN	VA,AH	PM	KF	CF,TA		MP	UZ	LK,MA
	Semifinishing	TK,OKM Without chipbreaker	MG,RT	RP,UN	V,AE	PM	KM	CM	KQ,KG, C,	B25,MK	GZ(UX)	MK,GK,
	Roughing	OPR,平板	KT,RT	平板	RE	平板	KR,KRR	CH,平板	KH,GC,ZS	MA,RK		PK, 平板
S	Finishing	OSF	EA,SF	FS			SF	HRF	MQ	VP2	EF	FJ
	Semifinishing	OSM	ML,MP, SU,MK	NG,UP,MS		VI	NGP,SM	HRM, HMM,SA	SQ,MS, MU,TK	VP3	EG,EX	MS
	Roughing	OSM		RP			SR,SMR		SG,SX	VP4	MU,EM	RS,GJ

Comparison Table for Turning Insert Chipbreaker

Positive Inserts

ISO	Processing Category	OKE	TaeguTec	KENAMETAL	HITACHI	ZCCCT	SANDVIK	TUNGALOY	KYOCERA	KORLOY	SUMITOMO	mitsubishi
P	Finishing	OTF	FA,SA,FG	LF,FP	JQ	SF,HF	PF,UF,XF	01,PF FS,JS	PF,DP,GP, PP,VF	VL,VF	FC,FB, LU(FP,FK)	FP,FV, LP,SV
	Finishing(Wiper)		WS	FW			WF		WP		LUW,SDW	SW
	Semifinishing	OTM	PC,MT, PMR	MF,MP	JE	HM	XM,PM, UM,PR,XR	PM,PS,PF PSF,PSS 23,24	HQ,GK,	HMP,MP	MU	MV,MP, 全周
	Semifinishing(Wiper)	OTR	WT	MW			WM,PR, UR,KM					MW
M	Finishing	MSF,OTF		FP,FF	MP	EF	MF	SS&	CF,CK,GQ, GF,MQ,SK	VP1	FC	FM,LM
	Semifinishing	OTM		MP,UP		EM	MM	PM	HQ,GK	VL	MU	MM, 通槽
K	Semifinishing	OTM		MW,平板		HR,HM, 平板	KM,KR,KF	CM CM Without chipbreaker	平板	MP	MU	MK,通槽, 平板
S	Finishing			GT-LF,R,GV, GT-HP		NF,NSF	SF,01			VP1		FS,LS, FS-P, LS-P,FJ, LS,MS
	Semifinishing	OSM		MT-LF,R,GV-T, MT-FP			MM,QM, SMR		MQ	VL	SI	
N	General cutting	NL,AK	FL	GT-HP,GT-LF, GW-F,GW-E		LH	AL	PP,AL	AH	AK,AR	AG,AW,AY	AZ

Material Comparison

Steel

ISO	Nations And Standard										
	GB (P类)	W-nr	DIN	AISI/SAE	BS	EN	UNI	UNE	SS	AFNOR	JIS
Carbon Steel	15	1.0401	C15	1015	080M15		C15C16	F.111	1350	CC12	
	20	1.0402	C22	1020	050A20	2C	C20C21	F.112	1450	CC20	
	35	1.0501	C35	1035	060A35		C35	F.113	1550	CC35	
	45	1.0503	C45	1045	080M40		C45	F.114	1650	CC45	
	55	1.0535	C55	1055	070M55		C55		1655		
	60	1.0601	C60	1060	080A62	43D	C60			CC55	
	Y15	1.7015	9SMN28	1213	230M07		CF9SMn28	11SMn28	1912	S250	SUM22
Manganese Steel	40Mn	1.1157	40Mn4	1039	150M36	15				35M5	
	25	1.1158	Ck25	1025							S25C
	35Mn2	1.1167	36Mn5	1335				36Mn5	2120	40Mn5	SMn438(H)
	30Mn	1.117	28Mn6	1330	150M28	14A	C28Mn			20M5	SCMn1
	35Mn	1.1183	Cf35	1035	060A35		C36		1572	XS38TS	S35C
	1.0718	9SMnPb28	12L13				CF9MnPb28	11SMnPb28	1914	S250Pb	SUM22L
	1.0722	10SPb20					CF10Pb20	10SPb		10PbF2	
	1.0726	35S20	1140	212M36	8M		F210G	1957	35MF4		
Y13	1.0736	9SMn36	1215	240M07	1B	CF9SMn36	12SMn35			S300	
	1.0737	9SMnPb36	12L14				CF9SMnPb36	12SMnPb35	1926	S300Pb	
55Si2Mn	1.0904	55Si9	9255	250A53	45	55Si8	56Si7	2085	55S7		
	1.0961	60SiCr7	9262			60SiCr8	60SiCr8		60SC7		
15	1.1141	Ck15	1015	080M15	32C	C16	C15K	1370	XC12	S15C	
Ck45	1.1191	45	1045	080M46		C45	C45K	1672	XC42	S45C	
55	1.1203	Ck55	1055	070M55		C50	C55K		XC45	S55C	
50	1.1213	Cf53	1050	060A52		C53		1674	XC48TS	S50C	
60Mn	1.1221	Ck60	1060	080A62	43D	C60		1678	XC60	S68C	
	1.1274	Ck101	1095	060A96				1870		SUP4	
	1.3401	X120Mn12		Z120M12		XG120Mn12	X120Mn12		X120M12	SCMnH/1	
Gr15,45Gr	1.3505	100Cr6	52100	534A99	31	100Cr6	F.131	2258	100C6	SUJ2	
	1.5415	15Mo3	ASTMA204Gr,A	1501-240		16Mo3KW	16Mo3	2912	15D3		
	1.5426	16Mo5	4520	1503-245-420		16Mo5	16Mo5				
	1.5622	14Ni6	ASTMA350LF5			14Ni6	15Ni6		16N6		
	1.5662	X8Ni9	ASTM A353	1501-509:510		X10Ni9	XBNI09				

Material Comparison

Steel

ISO	国家和标准 Nations And Standard										
	GB (P类)	W-nr	DIN	AISI/SAE	BS	EN	UNI	UNE	SS	AFNOR	JIS
Nickel Chromium Steel		1.5680	12Ni19	2515						Z18N5	
		1.5710	36NiCr6	3135	640A35	111A				35NC6	SNC236
		1.5732	14NiCr10	3415			16NiCr11	15NiCr11		14NC11	SNC415(H)
		1.5752	14NiCr14	3415, 3310	655M13 655A12	36A				12NC15	SNC815(H)
Nickel Chromium Molybdenum Steel		1.6511	36CrNiMo4	9840	816M40	110	38CrNiMo4(KB)	35CrNiMo4		40NCD3	
		1.6523	21NiCrMo2	8620	850M20	362	20NiCrMo2	20NiCrMo2	2503	20NCD2	SNCM220(H)
		1.6546	40NiCrMo2	8740	311-Type7		40NiCrMo2(KB)	40NiCrMo2			SNC240
	40CrNiMoA	1.6582	34CrNiMo6	4340	817M40	24	35CrNiMo6(KB)		2541	35NCD6	
	1.6587	17CrNiMo6		820A16			14CrNiMo13		18NCD6		
Chromium Steel	15Cr	1.7015	15Cr3	5015	523M15					12C3	SCr415(H)
	35Cr	1.7033	34Cr4	5132	530A32	18B	34Cr4(KB)	35Cr4		32C4	SCr430(H)
	40Cr	1.7035	41Cr4	5140	530M40	18	41Cr4	42Cr4		42C4	SCr440(H)
	40Cr	1.7045	42Cr4	5140				42Cr4	2245		SCr440
Manganese Chromium Steel	18CrMn	1.7131	16MnCr15	5115	527M20		16MnCr15	16MnCr15	2511	16MC5	
	20CrMn	1.7176	55Cr3	5155	527A60	48				55C3	SUP9(A)
	30CrMn	1.7218	25CrMo4	4130	1717CDS110		25CrMo4(KB)	55Cr3	2225	25CD4	SCM420; SCM430
	35CrMo	1.722	34CrMo4	4137, 4135	708A37	19B	35CrMo4	34CrMo4	2234	35CD4	SCM432 SCR3M3
	40CrMoA	1.7223	41CrMo4	4140, 4142	708M40	19A	41CrMo4	41CrMo4	2244	42CD4TS	SCM440
	42CrMo, 42CrMnMo	1.7225	42CrMo4	4140	708M40	19A	42CrMo4	42CrMo4	2244	42CD4	SCM440(H)
Chromium Molybdenum Steel		1.7262	15CrMo5					12CrMo4	2216	12CD4	SCM415(H)
		1.7335	13CrMo44	ASTM A182 F11 F12	1501-620Cr. 27		14CrMo44	14CrMo45		15CD3.5;15CD4.5	
		1.7361	32CrMo12		722M24	40B	32CrMo12	F.124.A	2240	30CD12	
		1.738	10CrMo910	ASTM A182 F22	1501-622Cr.31;45		12CrMo9,10	TU.H	2218	12CD9;10	
		1.7715	14MoV63		1503-660-440			13MoCrV6			
	50CrVA	1.8159	50CrV4	6150	735A50	47	50CrV4	51CrV4	2230	50CV4	SUP10
		1.8509	41CrAlMo7		905M39	41B	41CrAlMo7	41CrAlMo7	2940	40CAD6,12	
	1.8523	39CrMoV139		897M39	40C	36CrMoV12					

Material Comparison

Steel

ISO	Nations And Standard										
	GB (P类)	W-nr	DIN	AISI/SAE	BS	EN	UNI	UNE	SS	AFNOR	JIS
Steel	T10	1.1545	C105W1	W.110			C98KU C100KU	F.515 F.516	1880	Y1105	
	T12A	1.1663	C125W	W.112			C120KU	(C120)		Y2120	SK2
	CrV,9SiCr	1.2067	100Cr6	L3	BL3			100Cr6		Y100C6	
	Cr12	1.208	X210Cr12	D3	BD3		X210Cr13KU X250Cr12KU	X210Cr12		Z200Cr12	SKD1
	4Cr5MoVSi	1.2344	X40CrMoV51	H13	BH13			X40CrMoV5	2242	Z40CDV5	SKD61
	Cr6WV	1.2363	X100CrMoV51	A2	BA2		X35CrMoV05KU X40CrMoV51KU	X100CrMoV5	2260	Z100CDV5	SKD12
	CrWMo	1.2419	105WCr6				X100CrMoV51KU	105WCr5	2140	105WC13	SKS31 SKS2 SKS3
	Cr12W	1.2436	X210CrW12				10WCr6 107WCr5KU	X210CrW12	2312		SKD2
	5CrNiMo	1.2542	45WCrV7	S1	BS1		X215CrW121KU	45WCrS8	2710		
	3Cr2W8V	1.2581	X30WCrV93 X30WCrV93KU	H21	BH21		45WCrV8KU	X30WCrV9		Z30WCV9	SKD5
	Cr12MoV	1.2601	X165CrMoV12				X28W09KU X30WCrV93KU	X160CrMoV12	2310		SKD11
	5CrNiMo	1.2731	55NiCrMoV6	L6			X165CrMoV12KU	F.250.S		55NCDV7	SKT4
	V	1.2833	100V1	W210	BW2					Y1105V	SKS43
	W6Mo5Cr4V2Co5	1.3243	S6-5-2-5					HS6-5-2-5	2723	Z85WDCV	SKH55
	W18Cr4VCo5	1.3255	S18-1-2-5	T4	BT4		HS6-5-2-5	HS18-1-1-5		Z80WCV 10-05-04-1	SKH3
	W6Mo5Cr4V2	1.3343	S6-5-2S	M2	BM2		X78WCo1805KU	HS6-5-2	2722	Z85WDCV 06-05-04-02	SKH9
		1.3348	S2-9-2	M7		Z	X82WMo0605KU	HS-2-9-2	2782	Z100WCWV 09-02-04-02	
	W18Cr4V	1.3355	S18-0-1	T1	BT1		HS2-9-2	HS18-0-1		Z80WCV 18-04-01	SKH2
	W6Mo5Cr4V3		S6-5-3	M3			X75W18KU				SKH52
			M42	BM42						SKH59	

Material Comparison

Steel

ISO	国家和标准 Nations And Standard						
	GB (P类)	W-nr	DIN	JIS	DAIDO	AISI/SAE	
Die Steel					PX5N	P20mod	
					NAK55		
					NAK80		
		3Cr13			SUS420J2mod	S-STAR	420mod
					SKS93	YK30	2
		9CrWMn			SKS3mod	GOA	01mod
		Cr12MoV	X165CrMoV12		SKD11	DC11	D2
					SKD11mod	DC53	D2mod
		4Cr5MoSiV1	X40CrMoV51		SKD61	DHA1	H13
						DH21	
						DH31-S	
					DH2F		

Material Comparison

Stainless Steel

ISO	国家和标准 Nations And Standard										
	GB (P类)	W-nr	DIN	AISI/SAE	BS	EN	UNI	UNE	SS	AFNOR	JIS
Stainless Steel	0Cr13;1Cr12	1.4000	X6Cr13	403	403S17		X6Cr13	F.3110	2301	Z6C13	SUS403
		1.4001	X7Cr14					F.8401			
	1Cr13	1.4006	X10Cr13	410	410S21	56A	X12Cr13	F.3401	2302	Z10C14	SUS410
	1Cr17	1.4016	X6Cr17	430	430S15	60	X8Cr17	F.3113	220	Z8C17	SUS430
	2Cr13	1.4021	X20Cr13	410	S62	56B; 56C	X20C13	F.3401		Z20C13	SUS410
		1.4027	G-X20Cr14		420C29	56B				Z20C13M	SCS2
	4Cr13	1.4034	X46Cr13		420S45	56D	X40Cr14	F.3405	2304	Z40CM;Z38C13M	SUS420J2
	1Cr17Ni2	1.4057	X20CrNi172	431	431S29	57	X16CrNi16	F.3427	2321	Z15CNi6.02	SUS431
	Y1Cr17	1.4104	X12CrMoS17	430F			X10CrS17	F.3117	2383	Z10CF17	SUS430F
	1Cr17Mo	1.4113	X6CrMo171	434	434S17		x8CrMo17		2325	Z8CD17.01	SUS434
		1.4313	X5CrNi134		425C11					Z4CND13.4M	SCS5
		1.4408	G-X6CrNiMo1810		316C16			F.8414			SCS14
	4Cr9Si2	1.4718	X45CrSi93	HW3	401S45	52	X45CrSi8	F.322		Z45CS9	SUH1
	0Cr13Al	1.4724	X10CrAl13	405	403S17		X10CrAl12	F.311		Z10C13	SUS405
	Cr17	1.4742	X10CrAl18	430	430S15	60	X8Cr17	F.3113		Z10CAS18	SUS430
8Cr20Si2Ni	1.4757	X80CrNiSi20	HNV6	443S65	59	X80CrSiNi20	F.320V		Z80CSN20.02	SUH4	
2Cr25N	1.4762	X10CrAl24	446			X16Cr26		2322	Z10CAS24	SUH446	
Stainless Steel	0Cr18Ni9	1.4301	X5CrNi1810	304	304S15	58E	X5CrNi1810	F.3551 F.354 F.3504	2332	Z6CN18.09	SUS304
	1Cr18Ni9MoZr	1.4305	X10CrNiS189	303	303S21	58M	X10CrNiS18.09	F.3508	2346	Z10CNF18.09	SUS303
	0Cr19Ni10	1.4306	X2CrNi1911	304L	304S12		X2CrNi18.11	F.3503	2352	Z2CN18.10	SCS19
		1.4308	G-X6CrNi189		304C15					Z6CN18.10M	SCS13
	Cr17Ni7	1.4310	X12CrNi177	301			X12CrNi1707	F.3517	2331	Z12CN17.07	SUS301
		1.4311	X2CrNiN1810	304LN	304S62				2371	Z2CN18.10	SUS304LN
	0Cr19Ni9	1.4350	X5CrNi189	304	304S31	58E	X5CrNi1810			Z6CN18.09	SUS304
	0Cr17Ni11Mo2	1.4401	X5CrNiMo1712	316	316S16	Z6CND17.11	X5CrNiMo1712	F.3543	2347	1.4401	SUS316
	00Cr17Ni13Mo2	1.4429	X2CrNiMoN17133	316LN					2375	Z2CND17.13	SUS316LN
	0Cr27Ni12Mo3	1.4435	X2CrNiMo18143	316L	316S12		X2CrNiMo1713		2353	Z2CDN17.13	SCS16
	00Cr19Ni13Mo3	1.4438	X2CrNiMo17133	317L	317S12		X2CrNiMo18.16		2367	Z2CND19.15	SUS317L
		1.4460	X8CrNiMo275	329L					2324		SUS329L; SCH11 SCS11
	1Cr18Ni9Ti	1.4541	X6CrNiTi1810	321	2337	321S12	X6CrNiTi1811	F.3553	58B	Z6CNT18.10	SUS321
	1Cr18Ni11Nb	1.4550	X6CrNiNb1810	347	347S17	58F	X6CrNiTi1811	F.3552	2338	Z6CNNb18.1	SUS347
	Cr18Ni12Mo2Ti	1.4571	X6CrNiMoTi17122	316Ti	320S17	58J	X6CrNiMoTi17	F.3535	2350	Z6NDT17.12	
Stainless Steel		1.4581	G-X5CrNiMoNb1810		318C7		XG8CrNiMo18			Z4CNDNb1812M	SCS22
	Cr17Ni12Mo3Nb	1.4583	X10CrNiMoNb1812	318			X6CrNiMoTiNb17			Z6CNDNb1713B	
	1Cr23Ni13	1.4828	X15CrNiSi2012	309	309S24					Z15CNS20.1	SUH309
	0Cr25Ni20	1.4845	X12CrNi2521	310S	310S24		X6CrNi2520	F.331	2361	Z12CN2520	SUH310
	Cr15Ni36W3Ti	1.4864	X12NiCrSi3616	330						Z12CN35.1	SUH330
		1.4865	G-X40NiCrSi3818		330C11		XG50NiCr3919				SCH15
	5Cr2Mn9Ni4N	1.4871	X53CrMnNiN219	EV8	349S54;321S12	58B	X53CrMnNiN219			Z52CMN21.0	SUH35
1Cr18Ni9Ti	1.4878	X12CrNiTi189	321	321S320	58C	X6CrNiTi1811	F.3523		Z6CNT18.12	Su321	

Material Comparison

Cast Iron

ISO	国家和标准 Nations And Standard										
	GB (P类)	W-nr	DIN	AISI/SAE	BS	EN	UNI	UNE	SS	AFNOR	JIS
Nodular Iron	QT400-18		GGG40	60-40-18	400/17		GS370-17	FGE38-17	0717-02	FGS370-17	FCD400
	QT450-10			65-45-12	420/12		GS400-13	FGE42-12		FGS400-12	FCD450
	QT500-7		GGG50	70-50-05	500/7		GS500-7	FGE50-7	0727-02	FGS500-7	FCD500
	QT600-3		GGG60	80-60-03	600/7		GS600-2	FGE60-2	0732-03	FGS600-2	FCD600
	QT700-2		GGG70	100-70-03	700/2		GS700-2	FGE70-2	0737-01	FGS700-2	FCD700
	QT800-2		GGG80	120-90-02	800/2		GS800-2	FGE80-2	0864-03	FGS800-2	FCD800
	QT900-2				900/2						
Grey Cast Iron			GG40	NO.60					0140	FGL400	FC350
	HT350		GG35	NO.50	350	G35	FG35	0135	FGL350	FC300	
	HT300		GG30	NO.45	300	G30	FG30	0130	FGL300	FC250	
	HT250		GG25	NO.35	250	G25	FG25	0125	FGL250	FC200	
	HT200		GG20	NO.30	200	G20	FG20	0120	FGL200	FC150	
	HT150		GG15	NO.20	150	G15	FG15	0115	FGL150	FC100	
	Ht100				100	G10		0110			

Grade Comparison

	ISO Code	OKE	ZCCCT	MITSUBISHI	Korloy	TaeguTec	SUMITOMO	TUNGALOY	KYOCERA	HITACHI	SANDVIK	KENNAMETAL
CVD Turning	P01			UE6105		TT8105	AC8015P AC810P	T9205 T9105	CA510 CA5505	HG8010	GC4305 GC4315	KCP05B KCP05 KCPK05 KCK05B KCK05 KCK15B KCK15
	P10	OC2015 OC2115 OC2325	YBC151 YBC152	UE6105 MC6015 UE6110 MY5015	NC3215	TT8105 TT8115	AC8015P AC810P	T9205 T9105 T9215 T9115	CA510 CA515 CA5505 CA5515	HG8010	GC4305 GC4315 GC4325	KCP05B KCP05 KCPK05 KCP10B KCP10 KCK15B KCK15 KCK20B
	P20	OC2025 OC2125 OC2325	YBC251 YBC252	MC6015 UE6110 MC6025 UE6020 MY5015	NC3225 NC3120	TT5100 TT8125	AC8025P AC820P	T9215 T9115 T9225 T9125	CA025P CA525 CA5515 CA5525 CR9025	HG8025 IP2000 GM25	GC4315 GC4325 GC4225 GC1515	KCP10B KCP10 KCP25B KCP25 KCM15B KCM15
	P30	OC2035 OC2125 OC2135	YBC252 YBC351 YBC352	MC6025 UE6020 MC6035 UE6035 UH6400	NC3030	TT8125 T5100	AC8035P AC830P AC6030M AC630M	T9225 T9125 T9235 T9135 T6130	CA025P CA525 CA5525 CA530 CA5535 CR9025	IP3000 GM8035	GC4315 GC4325 GC4335 GC2025	KCP25B KCP25 KCP30B KCP30 KCM15B
	P40	OC2035	YBC351 YBC352	MC6035 UE6035 UH6400	NC5330	TT8135 TT7100	AC8035P AC830P AC6030M AC630M		CA530 CA5535	GM8035 GX30	GC4325 GC4335	KCP30B KCP30 KCP40B KCP40 KCM25B KCM25 KCM35B KCM35
	M10	OC4015 OC4315		MC7015 US7020	NC9115	TT9215	AC6020M AC610M	T9235 T9135 T6130	CA6515	IP1050S	GC2015 GC1515	KCM15B KCM15
	M20	OC4025 OC4225	YBM151 YBM153	MC7015 US7020 MC7025	NC9115 NC9125	TT9225	AC6020M AC6030M AC610M AC630M	T9215 T9115	CA6525	IP1050S	GC2015 GC2025 GC2020	KCP30B KCP30 KCP40B KCP40 KCM15B KCM15 KCM25B KCM25
	M30	OC4035	YBM151 YBM251	MC7025 US735	NC9125 NC9135	TT9235	AC6030M AC630M AC8035P AC830P	T6120 T9215 T9115		IP100S GX30	GC2025 GC2020	KCP40B KCP40 KCM25B KCM25 KCM35B KCM35
	M40		YB253	US735	NC9135	TT9235	AC6030M AC630M	T6130		IP100S GX30		KCM35B KCM35
	K01	OC3105	YBD052	MC5005 UC5105	NC6310	TT7005	AC4010K AC405K	T5105	CA310 CA4010 CA4505 CA5505	HX3505	GC3210	KCK05B KCK05
	K10	OC3115D OC3215	YBD102	MC5015 UC5115 MY5015	NC6310 NC6315	TT7015	AC4010K AC4015K AC405K AC415K	T5105 T515 T5115 T9215	CA310 CA315 CA4010 CA4115 CA4505 CA4515 CA5505	HX3505 HX3515 HG8010	GC3210	KCK05B KCK05 KCK15B KCK15
	K20	OC3115D OC3215	YBD152 YBD252	MC5015 UC5115 UE6110 MY5115	NC6315	TT7015 TT7025	AC4015K AC415K AC420K AC425K AC8025P	T515 T5115 T5125 T9215	CA315 CA320 CA4115 CA4120 CA4515	HX3515 HG8010	GC3210 GC3225	KCK15B KCK15 KCK20B KCK20
	K30	OC3125		UE6110				T5125	CA320	HG8010	GC3225	KCP05B KCP05 KCPK05 KCP10B KCP10 KCP25B KCP25 KCK20B KCK20

Grade Comparison

	ISO Code	OKE	ZCCCT	MITSUBISHI	Korloy	TaeguTec	SUMITOMO	TUNGALOY	KYOCERA	HITACHI	SANDVIK	KENNAMETAL
CVD Milling	P10					TT7515	ACP2000 ACP100				GC4220 GC4230 GC3040	KC930M KC935P
	P20		YBC301 YBC251	F7030 MC7020	NC5330	TT7515	ACP2000 ACP100	T3225			GC4220 GC4230 GC3040	SC6525 SP6519
	P30	OC4025 OC4225	YBM351	F7030 MC7020	NC5330 NC5340 NCM325	TT7800	ACP2000 ACP100	T3130 T3225			GC4230 GC3040 GC2040 M30B	MP91M SC6525 KCPK30 X500
	P40	OC4035	YBC302		NC5340 NC325 NCM325 NC5350 NCM335	TT7800					GC4240 GC4230 GC3040 GC2040 M30B	KCPK30 X500
	M10						ACM200					
	M20	OC4025 OC4225	YBM251 YBM253	F7030 MC7020	NC5330		ACM200	T3225	CA6535	GX2160 AX2040	GC2040 GC4230	SC6525
	M30	OC4035	YBM302	F7030 MC7020	NC5330 NC5340 NCM325 NC5350	TT7800	ACM200	T3225 T3130			GC2040 GC4230 GC4240 M30B S40T	SC6525 X500
	M40				NCM335 NC5350	TT7800					GC2040 M30B S40T GC4240	X500
	K10	OC3105 OC3115	YBD151	MC5020		TT7515	ACK2000 ACK100 ACK200	T1215 T1115				SC3025 KCK15
	K20	OC3115D OC3115	YBD252	MC5020	NC5330	TT7515	ACK200 ACK200	T1215	CA420M	GX2120	GC3220 K20W	KCK15 SC3025 MP91M
	K30	OC3125	YBD252		NC5340						GC3040	MP91M KCPK30 SC6525

Grade Comparison

	ISO Code	OKE	ZCCCT	MITSUBISHI	Korloy	TaeguTec	SUMITOMO	TUNGALOY	KYOCERA	HITACHI	SANDVIK	KENNAMETAL
PVD Turning	P10	OP1102	YBG102	VP10MF MS6015	PC8105		AC1030U ACZ150 AC5025S AC520U	AH710	PR930 PR1005 PR1025 PR1115 PR1215 PR1425 PR1225		GC1025 GC1125	KCS10 KCU10 KC5010
	P20	OP1205	YBG202	VP10RT VP20RT VP15TF VP20MF	PC8110 PC230	TT9020 TT9030	AC1030U AC5025S AC520U AC530U	AH120 AH725 AH730 SH725 SH730 J740	PR930 PR1025 PR1115 PR1215 PR1225 PR1625	IP2000	GC1025 GC1125	KCS10 KCU10 KCU25 KC5010 KC5025
	P30	OP1302	YBG202	VP10RT VP20RT VP15TF VP20MF	PC5300 PC8115	TT8020 TT8080 TT9030	AC1030U AC530U	AH120 AH725 AH7025 AH730 SH725 SH730 GH730 GH330 J740	PR1025 PR1225 PR1535	IP3000 CY250	GC1025 GC1125	KCU25 KC5025
	P40					TT8020 TT8080 TT9080	AC1030U	AH120 AH725 AH645		IP3000	GC1025	
	M10	OP1102 OP1205 OP1305	YBG202 YBG205	VP10MF MS6015	PC8105 PC8110	TT5080	AC515S AC5025S AC510U AC520U ACZ150	AH8005 AH630	PR1025 PR1215 PR1225	IP050S IP100S JP9105 JP9115	GC1115 GC1125	KCS10 KCU10 KC5010
	M20	OP1202 OP1215 OP1315 OP1525	YBG202 YBG205	VP10RT VP20RT VP15TF VP20MF	PC8110 PC8110 PC5300	TT5080 TT9080	AC5015S AC5025S AC1030U AC520U	AH8015 AH630 AH120 AH7025 AH725 SH725 SH730	PR930 PR1025 PR1125 PR1215 PR1425 PR1225 PR1515	IP100S HS9115	GC1115 GC1125 GC2035	KCS10 KCU10 KCU25 KC5010 KC5025
	M30	OP1205H OP1215 OP1302		VP10RT VP20RT VP15TF VP20MF MP7035	PC9030 PC5300 PC5400	TT8020 TT8080 TT9020 TT9080	AC5025S AC6040M AC1030U AC520U AC530U	AH645 AH120 AH725 SH725 SH730 J740	PR1125 PR1535		GC1125 GC2035	KCU25 KC5025
	M40			MP7035	PC5400	TT8020 TT8080 TT9020 TT9080	AC6040M AC1030U AC530U	AH645		GX30	GC2035	
	K10	OP1102					AC1030U AC510U ACZ150	GH110 AH110	PR905 PR1215	HX3305 HG3305 HX3515 HG8010 TH315 ATH10E	GC3330 GC3220 K20W K20D K20M K15W	KCS10 KCU10 KC5010
	K20	OP1202		VP10RT VP20RT VP15TF	PC5300		AC1030U AC510U AC530U ACZ150	AH120 AH7025	PR905 PR1215		GC3330 GC3220 GC3040 K20W K20D GC4230 K20M K15W	KCS10 KCU10 KCU25 KC5010 KC5025
	K30			VP10RT VP20RT VP15TF			AC1030U AC530U	AH120 GH130			GC3330 GC3040 K20W GC4240 GC4230	

Grade Comparison

	ISO Code	OKE	ZCCCT	MITSUBISHI	Korloy	TaeguTec	SUMITOMO	TUNGALOY	KYOCERA	HITACHI	SANDVIK	KENNAMETAL
PVD Turning	P10		YBG252		PC2005 PC2010 PC2015	TT2510 TT7080	ACP2500 ACP200	AH120 AH725	PR830 PR1025 PR1225	PCA12M PN15M PN215 JP4115	GC1010 GC1025 GC1030	KC5010M KC515M
	P20	OP1205 OP1305 OP2202	YBG202 YBG205 YBG9320 YBG252	MP6120 VP15TF	PC2505 PC2510	TT2510 TT7080 TT8020 TT9030 TT9080	ACP3000 ACU2500 ACP200 ACP300	AH120 AH725 AH3135 AH9030 AH3225 AH9130	PR1525 PR830 PR1025 PR1225 PR1230	CY150 CY9020 JP4120	GC1025 GC1030 GC2030	KC522M KC525M KCSM30 SP6519
	P30	OP1030 OP1130 OP1215 OP1302 OP1315 OP1325	YBG302	MP6120 VP15TF MP6130 VP30RT	PC3600 PC3500 PC210F PC5300	TT8020 TT8080 TT9030 TT9080	ACP3000 ACU2500 ACP200 ACP300	AH120 AH725 AH3135 AH130 AH3225 AH9130	PR1230 PR1535	HC844 CY25 CY250 CY259V JS4045	GC1030 GC1010 GC2030	KC525M KC530 KC725M KC735M KCPM40 KCSM30 X400
	P40		YBG302	VP30RT	PC5400	TT8020 TT8080 TT9030 TT9080	ACP3000 ACU2500 ACP300	AH140		PTH30E PTH40H JS4060 GX2140	GC1030 GC2030	KC725M KC735M KCPM40
	M10		YBG252		PC210F		ACU2500 ACM100 ACK300 ACP300	AH725	PR1025 PR1225	PN15M PN215	GC1010 GC1030	KC515M SP4019 SP6519
	M20	OP1202 OP1215 OP1205H	YBG202 YBG205 YBG9320 YBG252	VP15TF MP7130 MP7030 VP20RT	PC5300	TT9030 TT9080	ACU2500 ACK300 ACP300	AH725 AH3135 AH130 AH6030 AH3225 AH9130	PR1525 PR1025 PR1225	JP4120	GC1030 GC1040 GC2030 S30T	KC522M KC525M SP4019 SP6519 X700
	M30	OP1302	YBG302	VP15TF MP7130 MP7030 VP20RT MP7140	PC9530 PC5400	TT8020 TT8080 TT9030 TT9080	ACM300	AH3135 AH130 AH9130	PR1535	HC844 CY250 JS4045	GC1040 S30T GC2030	KC522M KC525M KC725M KC735M KCPM40 KCSM30 KCSM40 SC6525 X700
	M40		YBG302	MP7140 VP30RT	PC5400	TT8020 TT8080 TT9030 TT9080	ACM300	AH140		PTH30E PTH40H JM4160 GX2160 AX2040		KC725M KCPM40 KCSM40
	K10	OP1102	YBG102 YBG252	MP8010	PC8110 PC6510	TT6080	ACK3000 ACU2500	AH110 GH120	PR510 PR905 PR1210	ATH10E TH315 CY100H	GC1010 GC1020	KC514M KC515M KCK20 SP4019
	K20	OP1202 OP2212	YBG152	VP15TF VP20RT	PC5300	TT6080	ACK3000 ACU2500 ACK300	AH120 AH9030 AH9130	PR905 PR1210	CY9020 CY150 PTH13S JP4120 GX2120	GC1020	KC514M KC520M KC524M KCK20 SP6519
	K30	OP1205 OP1205H		VP15TF VP20RT			ACK3000 ACU2500 ACK300	AH120		CY250 JS4045 GX2040		KC522M KC524M SP6519

Hardness Comparison

Hardness				Tensile Strength
Rockwell	Hardness(RH)	Vickers Hardness(VH)	Brinell Hardness(BH)	
HRC	HRA	HV	HB	
70.0	86.6	1037		
69.5	86.3	1017		
69.0	86.1	997		
68.5	85.8	978		
68.0	85.5	959		
67.5	85.2	941		
67.0	85.0	923		
66.5	84.7	906		
66.0	84.4	889		
65.5	84.1	872		
65.0	83.9	856		
64.5	83.6	840		
64.0	83.3	825		
63.5	83.1	810		
63.0	82.8	795		
62.5	82.5	780		
62.0	82.2	766		
61.5	82.0	752		
61.0	81.7	739		
60.5	81.4	726		
60.0	81.2	713		2555
59.5	80.9	700		2500
59.0	80.6	688		2450
58.5	80.3	676		2395
58.0	80.1	664		2345
57.5	79.8	653		2295
57.0	79.5	642		2250
56.5	79.3	631		2205
56.0	79.0	620		2160
55.5	78.7	609		2115
55.0	78.5	599		2075
54.5	78.2	589		2035
54.0	77.9	579		1995
53.5	77.7	570		1955
53.0	77.4	561		1920
52.5	77.1	551		1885
52.0	76.9	543		1850
51.5	76.6	534		1815

Hardness				Tensile Strength
Rockwell	Hardness(RH)	Vickers Hardness(VH)	Brinell Hardness(BH)	
HRC	HRA	HV	HB	
51.0	76.3	501		1780
50.5	76.1	494		1750
50.0	75.8	488		1720
49.5	75.5	481		1690
49.0	75.3	474		1660
48.5	75.0	468		1630
48.0	74.7	461		1605
47.5	74.5	455		1575
47.0	74.2	449		1550
46.5	73.9	442		1525
46.0	73.7	436		1500
45.5	73.4	430		1475
45.0	73.2	424		1450
44.5	72.9	418		1430
44.0	72.6	413		1405
43.5	72.4	407		1385
43.0	72.1	401		1360
42.5	71.8	396		1340
42.0	71.6	391		1320
41.5	71.3	385		1300
41.0	71.1	380		1280
40.5	70.8	375		1260
40.0	70.5	370		1245
39.5	70.3	365		1225
39.0	70.0	360		1210
38.5		355		1190
38.0		350		1175
37.5		345		1160
37.0		341		1140
36.5		336		1125
36.0		332		1110
35.5		327		1095
35.0		323		1080
34.5		318		1065
34.0		314		1050
33.5		310		1035
33.0		306		1020
32.5		302		1010

Hardness Comparison

Hardness				Tensile Strength
Rockwell	Hardness(RH)	Vickers Hardness(VH)	Brinell Hardness(BH)	
HRC	HRA	HV	HB	
32.0		304	298	995
31.5		300	294	980
31.0		296	291	970
30.5		292	287	960
30.0		289	283	950
29.5		285	280	935
29.0		281	276	920
28.5		278	273	910
28.0		274	269	900
27.5		271	266	890
27.0		268	263	880
26.5		264	260	870
26.0		261	257	860
25.5		258	254	850
25.0		255	251	835
24.5		252	248	830

Hardness				Tensile Strength
Rockwell	Hardness(RH)	Vickers Hardness(VH)	Brinell Hardness(BH)	
HRC	HRA	HV	HB	
24.0		249	245	820
23.5		246	242	810
23.0		243	240	800
22.5		240	237	790
22.0		237	234	785
21.5		234	232	775
21.0		231	229	765
20.5		229	227	760
20.0		226	225	750
19.5		223	222	745
19.0		221	220	735
18.5		218	218	730
18.0		216	216	725
17.5		214	214	715
17.0		211	211	710