

PRODUCT SPECIFICATION

Model No.: GD12011A/BX-X

Descriptions & Features:
<ul style="list-style-type: none"> ■ 1.2 Inch (30.60mm) digit height Single Digit Display ■ Case mold type. ■ RoHS compliant. ■ Low current operation ■ Low power consumption. ■ Easy mounting on P.C. board or socket.



CUSTOMER APPROVED SIGNATURES	APPROVED BY	CHECKED BY	PREPARED BY

GUANGCAI DISPLAY TECHNOLOGY CO.,LTD

ADD: No. 167, Shengshan Road, Yuecheng District, Shaoxing City, Zhejiang Province

Tel: +86-575-88626657

Fax: +86-575-88649799

E-mail: Sales@smddisplay.com (General)

Model No.: GD12011A/BX-X

■ -X: REF Surface

Color	Numbe	1	2
REF Surface Color		<input type="radio"/> Black	<input type="radio"/> Gray

■ Mechanical Dimensions

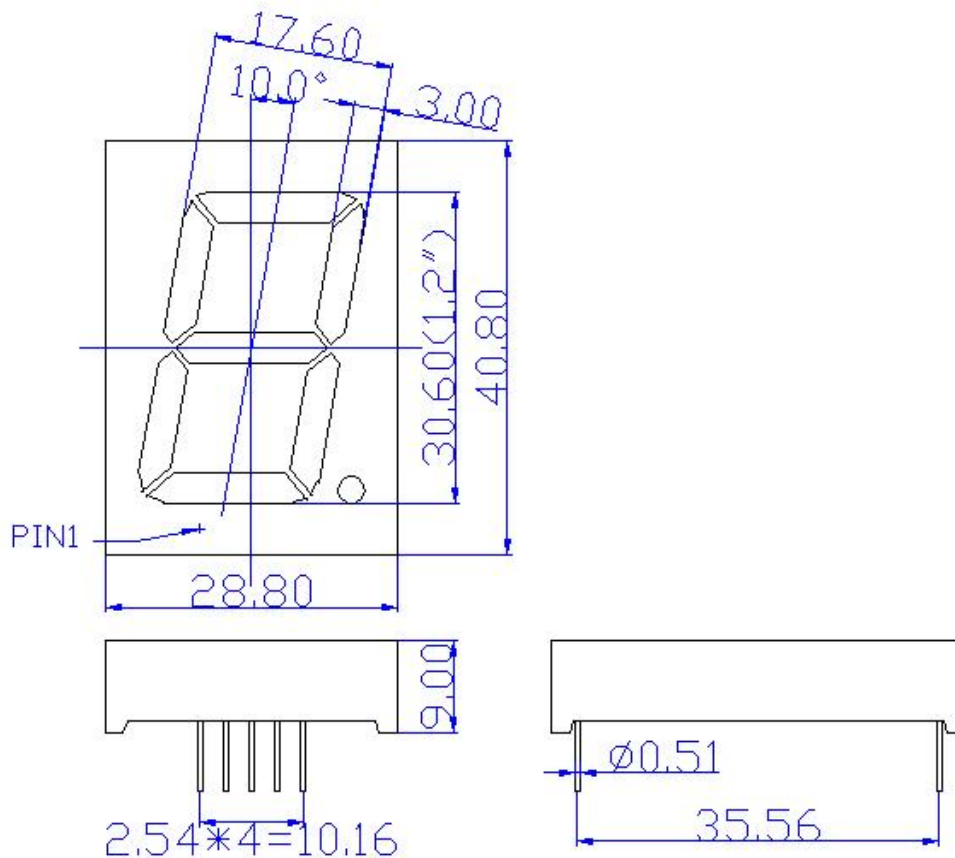

Notes:

1. All pins are $\Phi 0.45$ [.019]mm
2. Dimension in millimeter [inch], tolerance is ± 0.25 [.010] and angle is $\pm 1^\circ$ unless otherwise noted.
3. Bending \leq Length*1%.
4. The specifications, characteristics and technical data described in the datasheet are subject to change without prior notice.
5. The drawing is different from the actual one, please refer to the sample.

Model No.: GD12011A/BX-X

■ All Light On Segments Feature & Pin Position

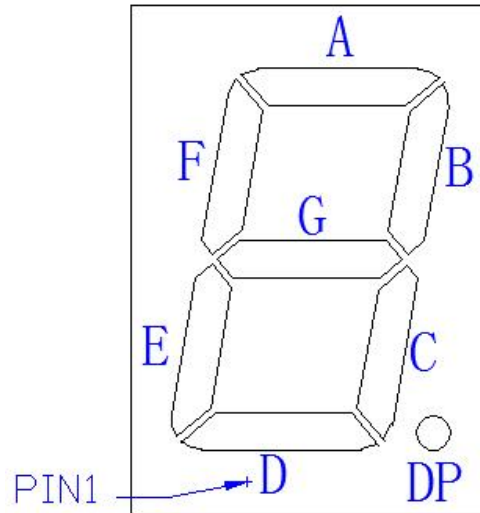

■ Internal Circuit Diagrams

GD12011AX

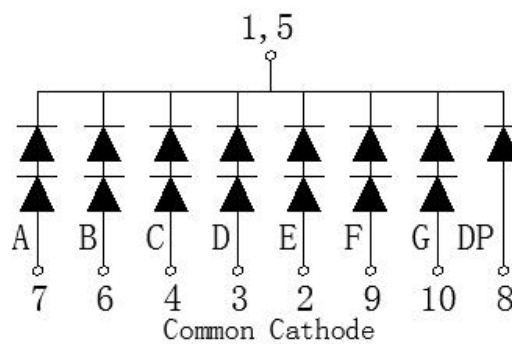

GD12011BX

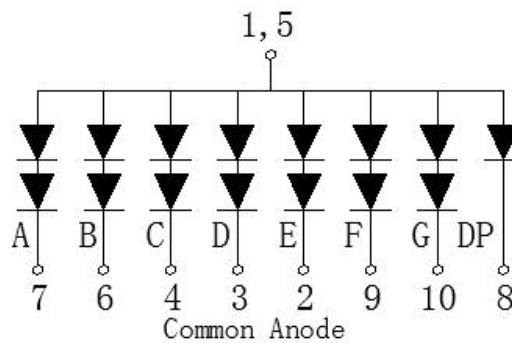

Model No.: GD12011A/BX-X

■ Absolute maximum ratings

(Ta=25℃)

Parameter	Symbol	Test Condition	Value		Unit
			Min	Max	
Reverse Voltage	VR	IR=30	5	—	V
Forward Current	IF	—	—	30	mA
Power Dissipation	Pd	—	—	100	mW
Pulse Current	Ipeak	Duty=0.1mS,1KHz	—	150	mA
Operating Temperature	Topr	—	-40	+85	℃
Storage Temperature	Tstr	—	-40	+85	℃

■ Electrical-Optical Characteristics

● Color Code & Chip Characteristics:(Test Condition:IF=10mA)

(Ta=25℃)

Emitting Color	Dice Material	Peak Wave Length(λ_p)	Dominant Wavelength(λ_d)	Spectral Line halfwidth ($\Delta\lambda_{1/2}$)	Forward Voltage(VF) Unit:V		Luminous Intensity (Iv) Unit:mcd	
					Typ	Max		
Ultra brightness								
R	Red	AlGaInP	660nm	645nm	20nm	2.00	2.50	20~50
SR	Orange	AlGaInP	632nm	625nm	20nm	2.00	2.50	40~85
A	Amber	AlGaInP	612nm	605nm	20nm	2.00	2.50	30~105
Y	Yellow	AlGaInP	592nm	590nm	20nm	2.00	2.50	30~135
G	Yellow Green	AlGaInP	572nm	570nm	30nm	2.00	2.50	20~60
PG	Pure Green	InGaN	*	520nm	36nm	3.00	3.80	350~450
B	Blue	InGaN/GaN	*	460nm	30nm	3.00	3.80	120~180
W	White	InGaN/GaN	X=0.29,Y=0.30	CCT:9500K		3.00	3.80	60~120~180
Segment-to-Segment Luminous Intensity ratio(Iv-M)					1.5:1			

Note:

1.Luminous Intensity is based on the Guangcai standards.

Model No.: GD12011A/BX-X

■ Packing Diagram

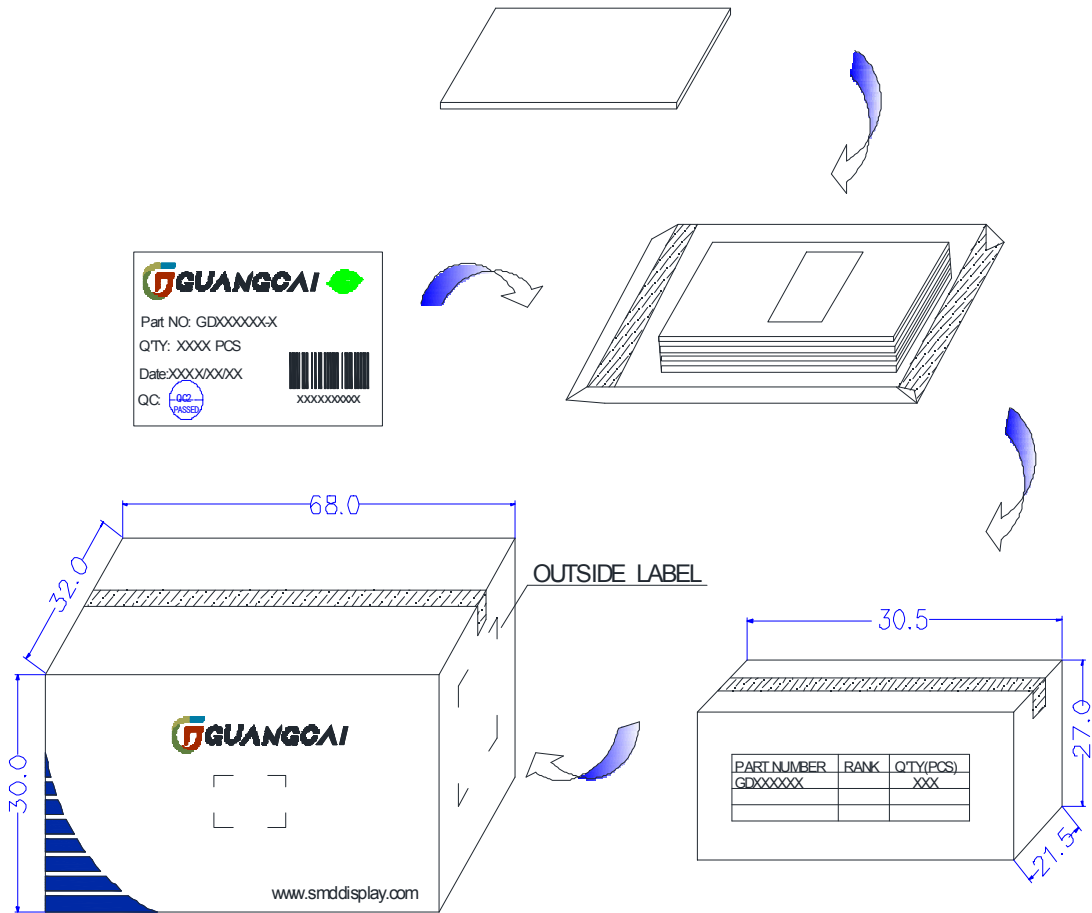

OUTSIDE LABEL

Note: The specifications are subject to change without notice. Please contact us for updated information.