

# AIR TECHNOLOGY SOLUTIONS FOR DEMANDING APPLICATIONS

Product overview industrial steel fans

# SET BENCHMARKS NOW.

Efficient and high-performance solutions from one source.



Elektor airsystems sp. z o.o., a subsidiary of Elektor airsystems gmbh headquartered in Ostfildern to the south-east of Stuttgart, is a specialist in fan construction. Employing technical skills and recognised quality, we develop industrial solutions for nearly all air technology requirements as well as for complex special areas of use to harness air as an effective working medium.

The centrifugal and axial models of our fans excel in maximum efficiency and economy, making them a reliable partner for all industrial areas of use.

The applied quality standards as per DIN EN ISO 9001:2008 ensure a continuously high level of quality. The technical design of our fans complies with DIN 24166. According to the EC machinery directive, all our fans bear the CE mark.







Moreover, our explosion-proof fans are designed and certified in accordance with directive 94/9/EC as per ATEX 95. Thanks to the modular and compact design of their aerodynamic structural form, Elektor's centrifugal and axial fans are well suited for a wide variety of industrial applications. Based on standardised assemblies, the robust structural shape ensures a maximum of reliability,

safety, and uptime. Areas of use for Elektor fans include process engineering, pneumatic conveying technology, and exhaust air cleaning in automotive, chemical, paper, and food as well as ventilation and air-conditioning engineering applications.



# FOR THE HIGHEST STANDARDS.

Process fans of true magnitude.



Our standard fan design is based on powder-coated construction steel. Using high-alloy acid-, rust- and temperature-resistant coating systems reinforces their resistance to corrosion and abrasion. Depending on their use case, the blade configuration of the aerodynamically and acoustically optimised impellers is backwards-bent or has a centrifugal ending, without a cover plate in case of transport fans.

Above all, they excel in very high efficiency across a wide operating range. All our impellers are statically or dynamically balanced according to DIN ISO 1940. Depending on the individual requirements, our fan housings' solid structural form has simple or gas-tight welding seams and can be designed with a variety of shaft sealing systems. All our fans can be arranged with a dual bearing shaft for a flexible coupling drive or for

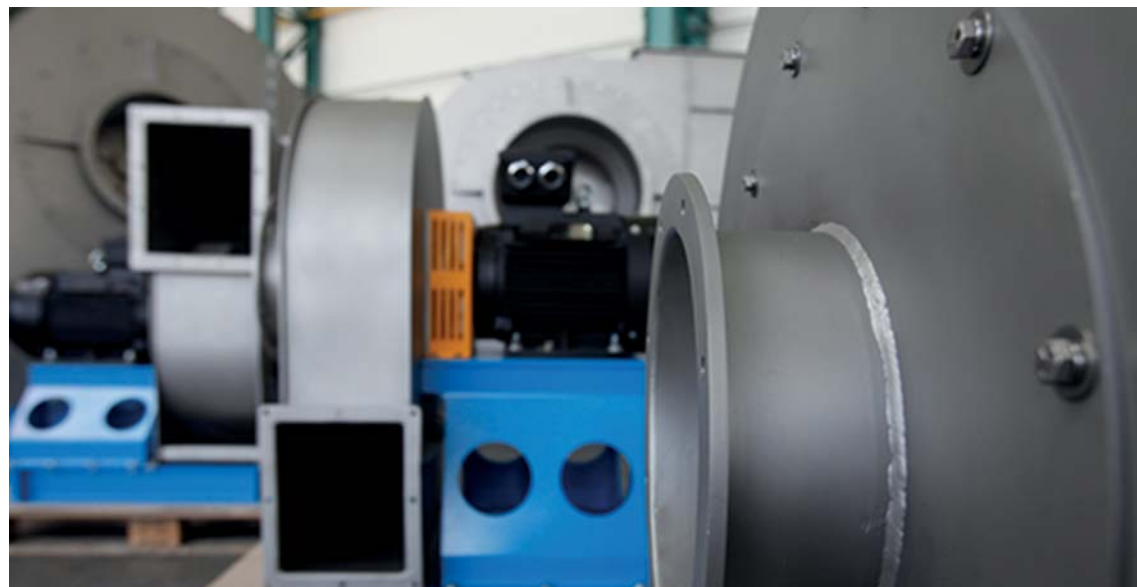





a belt drive. Possible bearing types are grease- or oil-lubricated individual pedestal bearings or block bearings. A direct drive using one impeller on a motor shaft as the simplest drive type not only has an attractive purchase price and low operating costs but is also the most compact of all possible drive types.

The versions include:

- Volume flows of up to 600,000 m<sup>3</sup>/h
- Pressure increase of up to 35,000 Pa
- Medium operating temperature between -40 °C and +600 °C
- Drive output of up to 800 kW



# VERSATILE USE.

Tailored custom solutions  
for your system.



## Production facts at a glance:

- 3,500 m<sup>2</sup> production space
- 500 m<sup>2</sup> painted surface (powder-coated)
- 3,000 m<sup>2</sup> bearing space
- Fully automatic Trumpf laser cutting system
- High-performance Schenk balancing system for impellers with a diameter of up to 2.5 m
- Bystronic bending press with a press capacity of up to 200 t
- Fully equipped welding work stations
- Fully automatic bearing system for steel sheets
- Multiple measurement techniques and testing aids for standardised device final testing







**Our offering includes:**

- Customised and tailored custom solutions according to your air technology needs for volume flows of up to 600,000 m<sup>3</sup>/h and pressure of up to 35,000 Pa
- Innovative and versatile fans in centrifugal and axial structural forms
- Personal advice and customer service from experienced air technology experts
- A host of know-how in the air technology analysis and calculation
- Detailed project assistance from design to commissioning, and beyond
- Precisely aligned production processes allowing for a maximum of quality requirements
- Customised 3D models, spare parts lists, and exploded views
- Extensive documentation



# THE COMPACT

CFL - Centrifugal fans  
with steel / stainless steel housing



## Possible versions:

- ATEX (zones 1 and 2, gas and dust)
- Medium temperatures up to 750 °C
- Adjustable speed, frequency converter mode
- Various tightness levels possible
- Variety of sound insulation measures available
- Multiple certificates (GOST, UL, CSA, API 673)
- Application-oriented materials such as St37, St52, Naxtra 700, 1.4301, 1.4571, 1.4462, AISI316LI, 16Mo3, 1.7828
- Other special versions available on request

## Application examples:

- Drying plants
- Extraction
- Surface treatment

CFL

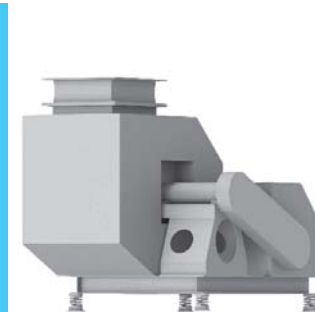

CFL

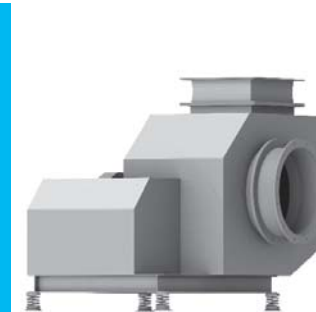

This reliable series has a track record and excels in a particularly robust design. Very high volume flows at a relatively low pressure loss enables numerous areas of use. Thanks to their compact dimensions, the devices can be used in special installation situations.

There is a wide range of accessories available in order to equip the fans according to individual requirements.

The fans are available as direct drive, belt drive, or coupling drive models.

Aspiration diameter: 280 mm to 2,500 mm

## Characteristic curve diagram

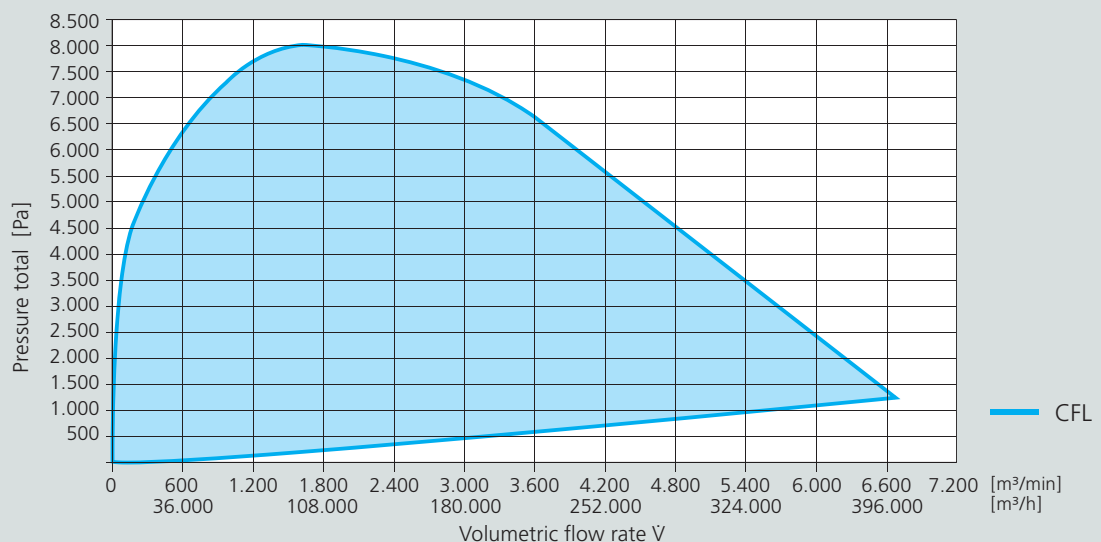



# THE ALL-ROUNDER

CFM - Centrifugal fans  
with steel / stainless steel housing

## Possible versions:

- ATEX (zones 1 and 2, gas and dust)
- Medium temperatures up to 750 °C
- Adjustable speed, frequency converter mode
- Various tightness levels possible
- Variety of sound insulation measures available
- Multiple certificates (GOST, UL, CSA, API 673)
- Application-oriented materials such as St37, St52, Naxtra 700, 1.4301, 1.4571, 1.4462, AISI316LI, 16Mo3, 1.7828
- Other special versions available on request

## Application examples:

- Process technology
- Extraction plants
- Incineration plants
- Boilers
- Burners

CFM

CFM

CFM



This series' optimised extraction-impeller geometry provides maximum air technology efficiency at low sound levels. Despite the potentially large volume flows at medium-high pressure, the CFM series also excels in efficient dimensions.

Naturally, these fans are also available in the classic drives types of direct, belt, and coupling. Aspiration diameter: 224 mm to 1,800 mm

## Characteristic curve diagram

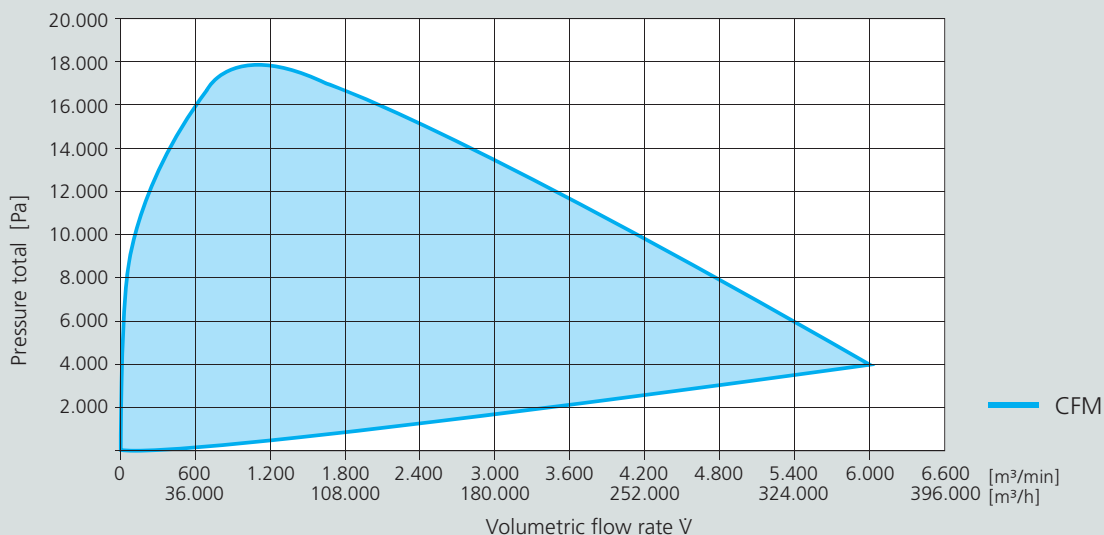

# THE POWERFUL

CFH - Centrifugal fans  
with steel / stainless steel housing

## Possible versions:

- ATEX (zones 1 and 2, gas and dust)
- Medium temperatures up to 750 °C
- Adjustable speed, frequency converter mode
- Various tightness levels possible
- Variety of sound insulation measures available
- Multiple certificates (GOST, UL, CSA, API 673)
- Application-oriented materials such as St37, St52, Naxtra 700, 1.4301, 1.4571, 1.4462, AISI316LI, 16Mo3, 1.7828
- Other special versions available on request

## Application examples:

- Process air
- Glass drying
- Granulate drying
- Hall air extraction
- Oxidation plants

CFH



CFH



CFH



Elektror's high pressure-centrifugal fans achieve very high pressure levels using medium to low volume flows. The series' enormously high output density also makes for a particularly compact structural shape and extreme robustness.

For applications with medium to low volume flows, our "powerful" is the perfect solution. On request, this series also comes equipped with the classic design versions such as direct coupling, or belt drive.

Aspiration diameter: 160 mm to 1,400 mm

## Characteristic curve diagram

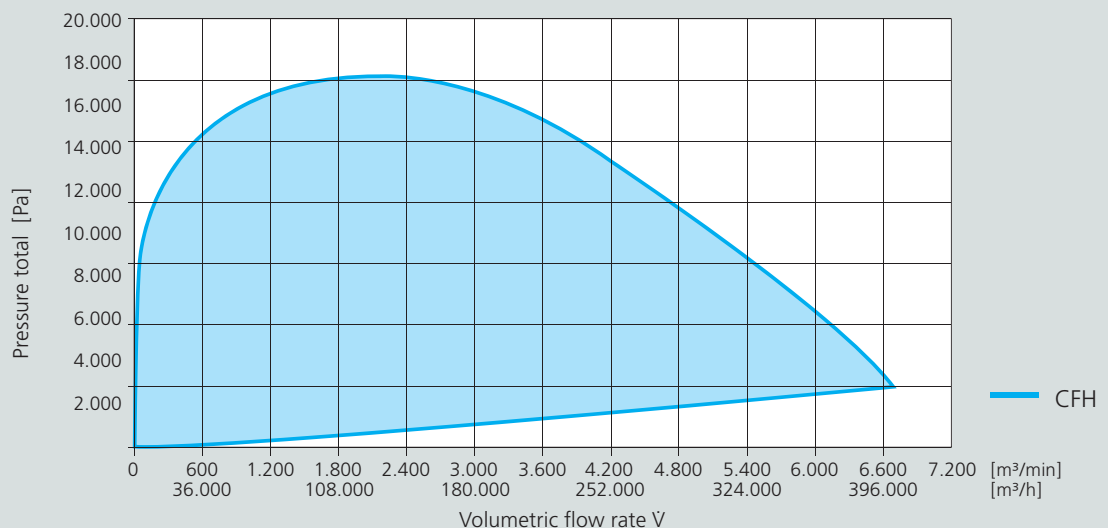

# THE LARGE

CFXH - Centrifugal fans  
with steel / stainless steel housing

## Possible versions:

- ATEX (zones 1 and 2, gas and dust)
- Medium temperatures up to 750 °C
- Adjustable speed, frequency converter mode
- Various tightness levels possible
- Variety of sound insulation measures available
- Multiple certificates (GOST, UL, CSA, API 673)
- Application-oriented materials such as St37, St52, Naxtra 700, 1.4301, 1.4571, 1.4462, AISI316LI, 16Mo3, 1.7828
- Other special versions available on request

## Application examples:

- Vacuum
- Drying technology
- Extraction

CFXH



CFXH



If you need to generate high pressure at low volume flows, use our CFXH series centrifugal fans - because high air speeds require a professional. Thanks to their particularly great speeds, the devices of this compact series achieve a very high circumferential speed.

Depending on your application, our large fans also come equipped with direct, coupling, or belt drive to choose from.

Aspiration diameter: 80 mm to 900 mm

## Characteristic curve diagram

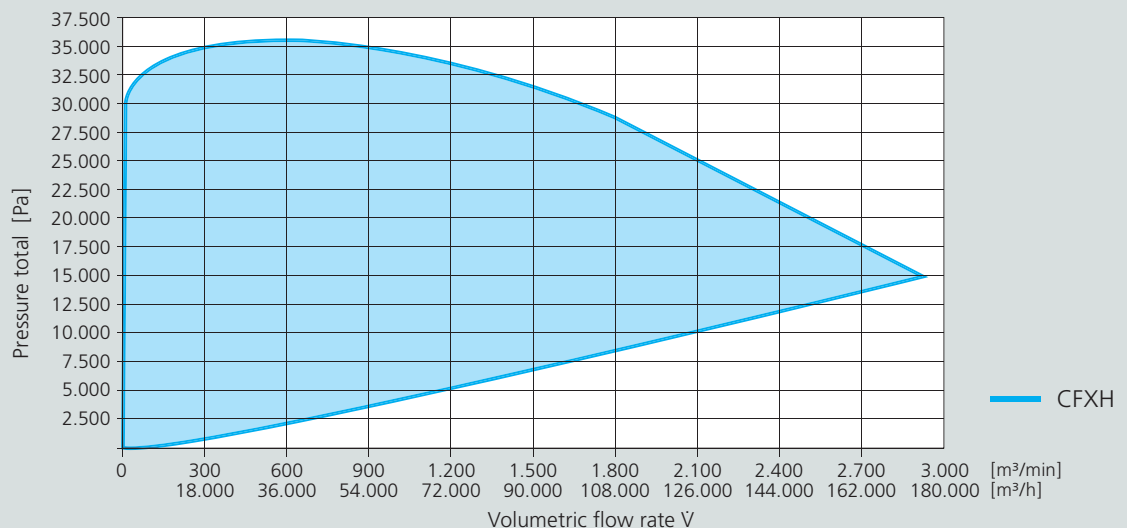



# THE GIANTS

CFLD - Centrifugal fans  
with steel / stainless steel housing

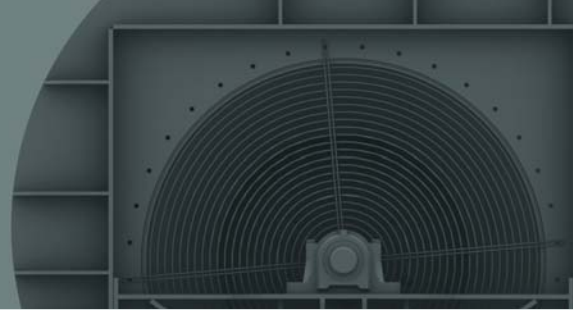

## Possible versions:

- ATEX (zones 1 and 2, gas and dust)
- Medium temperatures up to 750 °C
- Adjustable speed, frequency converter mode
- Various tightness levels possible
- Variety of sound insulation measures available
- Multiple certificates (GOST, UL, CSA, API 673)
- Application-oriented materials such as St37, St52, Naxtra 700, 1.4301, 1.4571, 1.4462, AISI316LI, 16Mo3, 1.7828
- Other special versions available on request

## Application examples:

- Painting plants
- Extraction
- Cooling

CFLD

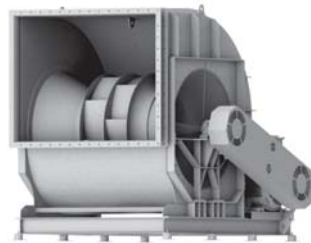

CFLD



When it comes to high air technology requirements, our CFLD series fans are setting standards! These centrifugal giants excel in extremely high volume flows at low to medium pressure. Seen in relation to device size, the enormous air technology ratings justify the observation that this series can also be called a "space saver."

The CFLD series, too, is available in our classic design variants of coupling or belt drive. Aspiration diameter: 400 mm to 2,240 mm

## Characteristic curve diagram

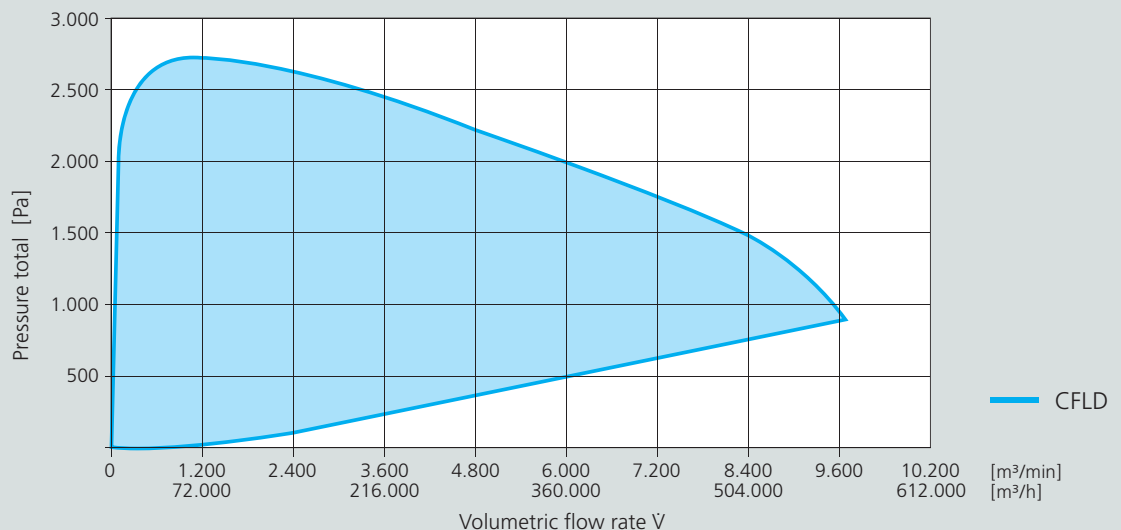

# THE LINEAR

## Axial fans



### Possible versions:

- ATEX
- Media temperatures up to 230 °C
- Increased protection class
- Suitable for frequency converters
- Multiple certificates (UL, Gost, UR/CSA)
- Other special versions available on request

### Application examples:

- Food industry
- Circulating air applications
- Ventilation

### MAF



### HAFC



Elektror Axial fans are used in a wide variety of areas. The robust versions are available as direct drive, belt drive as well as weather protected roof fans.

Moreover, special application-related versions as well as thermal or acoustic insulation measures can be implemented here.

### Characteristic curve diagram

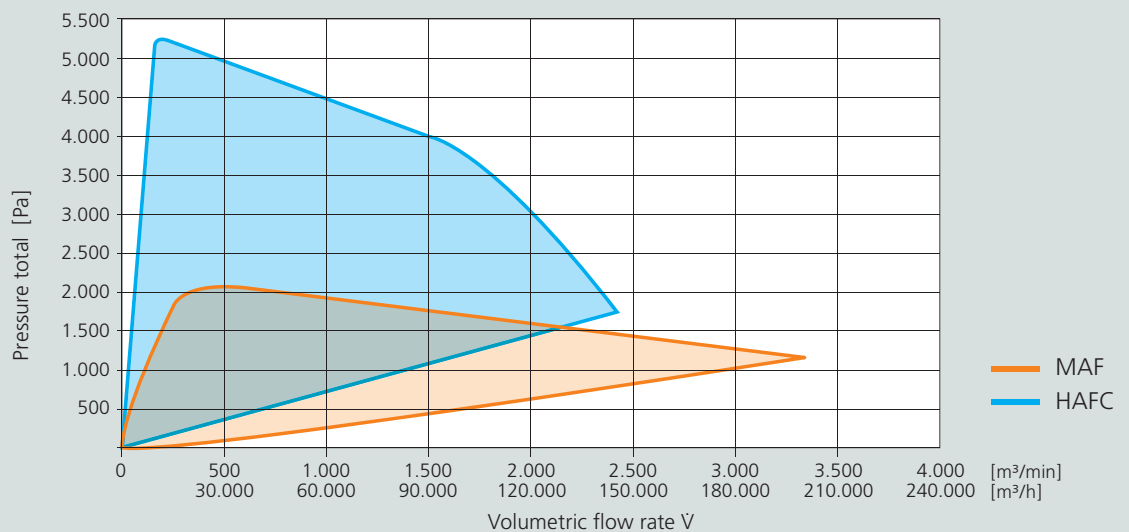

# THE TRANSPORTER

CFMT - Centrifugal fans  
with steel / stainless steel housing

## Possible versions:

- Media temperatures up to 230 °C
- Increased protection class
- Vibration monitoring
- Suitable for frequency converters
- Multiple certificates (GOST, UL, CSA)
- Other special versions available on request

## Application examples:

- Conveying granules
- Conveying bulk materials
- Transporting film

CFMT

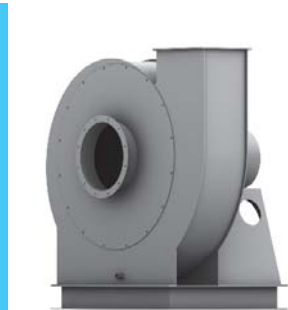

CFMT

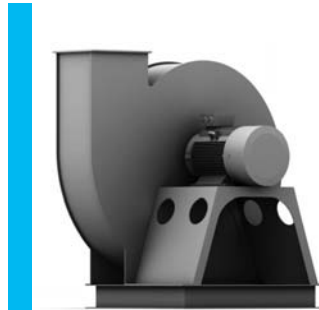

Elektror's conveying fans are equipped with special impeller geometry to directly and reliably convey a host of different materials. You can choose between steel and stainless steel housings.

The steel housings are available in different materials and predestined to customised adaptations.

## Characteristic curve diagram

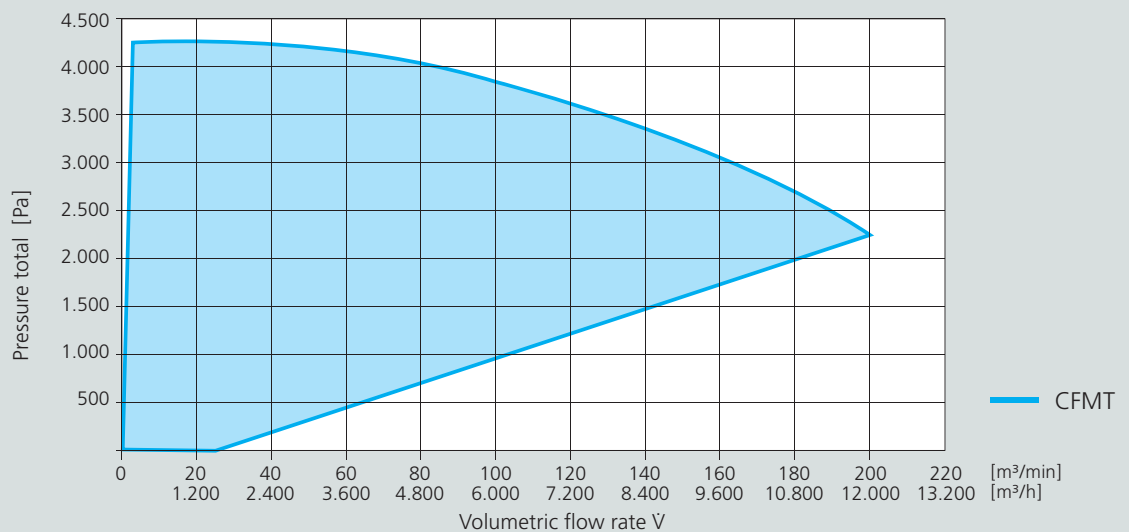



# DIE INTEGRATEABLE

## Plug fans

### Possible versions:

- ATEX
- Media temperatures up to 750 °C
- Increased protection class
- Suitable for frequency converters
- Application-specific materials
- Thermal insulation
- Multiple certificates (UL, Gost, UR/CSA)
- Other special versions available on request

### Application examples:

- Furnance construction
- Painting plants
- Drying and cleaning plants
- Air conditioning technology

### PFM/PFL direct drive



### PFM/PFL belt drive



Special installation situations require well thought-out solutions. It is often integrated applications that come with a customised design where a conversation with our experts is worth your while.

Naturally, direct as well as belt drives are also available. Adapted thermal or acoustic insulation measures are a particularly important option here.

### Characteristic curve diagram

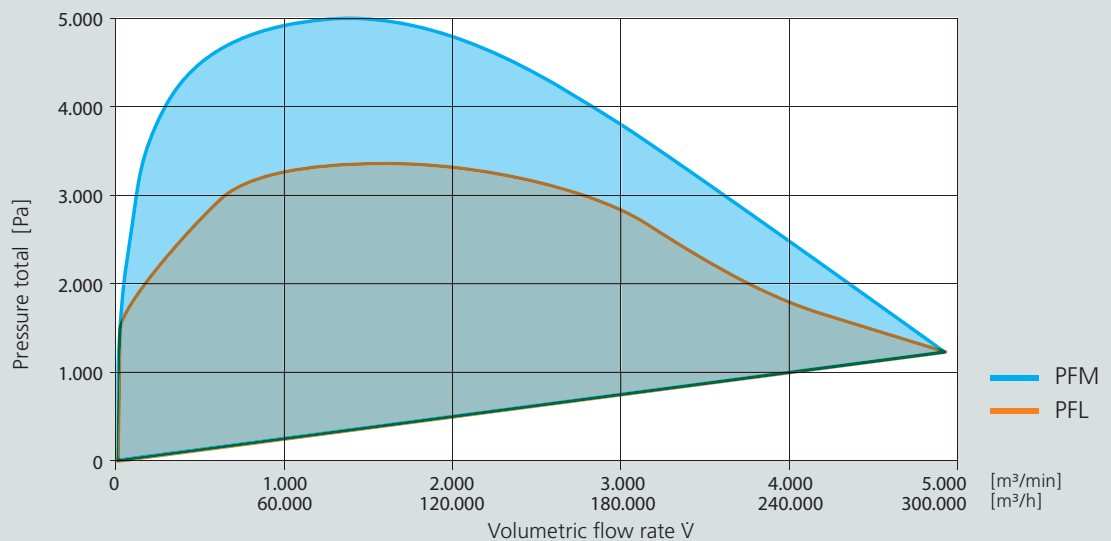

# THE QUIET

## Sound insulation measures

### Possible versions:

- Application-oriented materials
- For connection to pressure or extraction side
- Also available for large dimensions
- Integrated ventilation possible
- Installation- and maintenance-friendly
- Custom constructions on request

### Application examples:

- Building sites
- Production halls
- Air conditioning technology

### Sound insulation cabins



### Sound enclosures



### Tube silencers

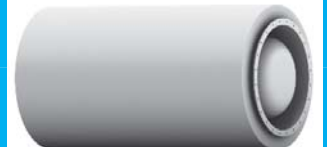

Numerous applications often require special sound insulation measures. Particularly in sensitive areas, Elektror's highly effective and robust sound reduction measures are the perfect solution. Sound reduction cabins and sound reduction jackets are available for internal as well as external installations, enabling sound reductions of up to 20 db(A)

when combined with other sound reduction measures such as housing and drive insulations. Moreover, thermal insulation measures are optionally available.

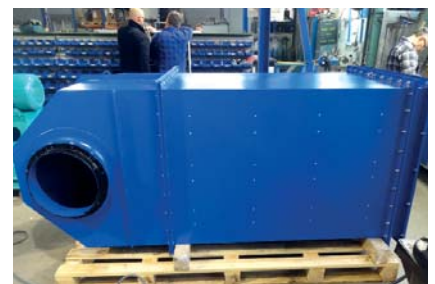

# FULL OF BENEFITS

## Accessory components

### Possible versions:

- Special accessories for ATEX versions
- Different customer-specific accessory solutions

### Noise reduction



- Sound insulation cabins
- Sound enclosures
- Tube silencers
- Splitter silencers

### Connection, Attachment, Assembly



- Connecting system components
- Adapter elements
- Intermediate elements
- Flanges
- Pressure and intake connections
- Inlet nozzles
- Y-sections
- Safety guards

### Control, Regulation, Throttling



- Frequency converter in a switch cabinet and mounted version
- Temperature sensors
- Vibration sensors
- Speed indicators
- Ring gauge line for volume flow detection
- Pressure monitor

### Vibration reduction



- Bonded rubber buffer
- Rubber vibration damper
- Spring vibration damper
- Vibration sensors
- Compensators for all applications

### Application



- Protective covers
- Insulation measures
- Filters





# FABULOUS

Our expertise  
for your application

Plants with a modern control system require and enable the precise use and detailed monitoring of fans, allowing an increase in efficiency and a decrease in downtimes. From straightforward, affordable, and manually adjustable analogue vibration sensors to complex, multi-dimensional, and holistic digital vibration monitoring - Elektor offers you optimised, application-oriented products.

We are happy to help you choose the right temperature sensors - basic or high-precision - for your needs (including ATEX certification).



- 1 Connection-friendly terminal box for all sensors
- 2 Sealing gas connection including flow rate and sealing gas pressure regulation and control
- 3 Touch guard
- 4 Combined vibration and temperature sensor
- 5 Cleaning aperture

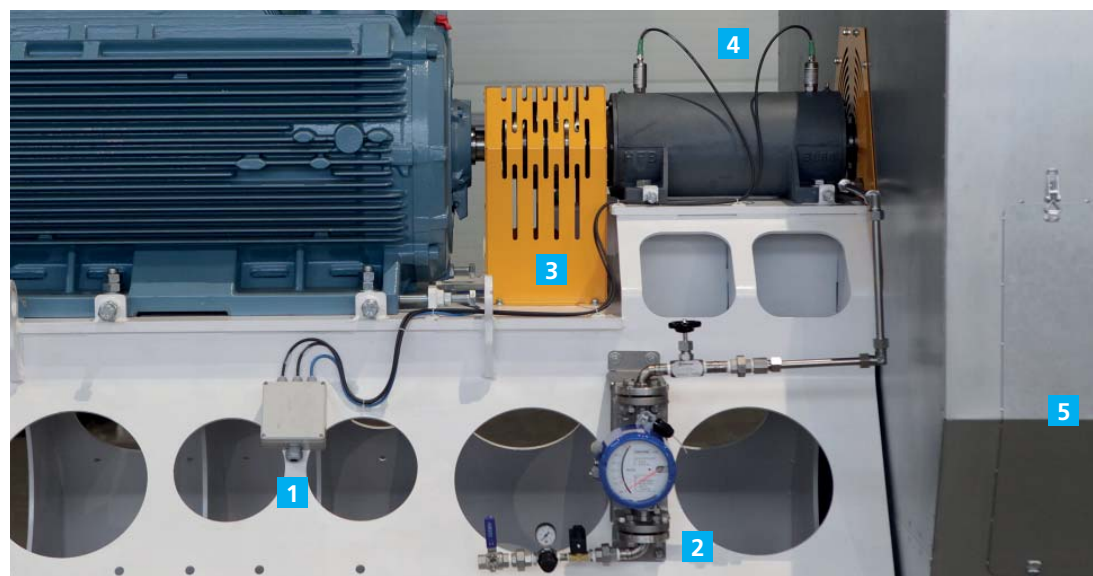

# ONE-OF A KIND

Customised steel /  
stainless steel industrial fans

[www.elektor.com](http://www.elektor.com)

Standard products can do a lot, but not everything. In some cases customer-specific solutions lead to the desired results. We are more than happy to confront all technical challenges together with our customers. With our first-class engineering competence in all aspects of air technology systems, we develop just the solution that satisfies the uniqueness of our customers.

Thanks to our experience for many years we are also able to make an exceptionally pragmatic approach to tailored solutions. In this way, we are very frequently able to be unique from the innovative idea up to the individual solution, even from an economical point of view. Elektor airsystems is a reliable and present partner from the first phase of the project.

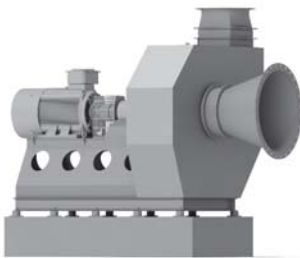

## CFH2 560

Volume flow: 38,000 m<sup>3</sup>/h,  
Pressure increase: 13,700 Pa,  
Medium temperature: 80 °C,  
Motor output: 250 kW,  
Motor speed: 2,982 min<sup>-1</sup>

Purpose-built, customised high pressure centrifugal fan for use in a nitrogen treatment plant.

### Distinctive features:

Stainless steel design, shaft sealing with sealing gas connection, sealing gas fitting, stainless steel compensators, gas-tight design, custom impeller from 1.4462, specially reinforced for high circumferential speeds



## 2x CFL2 900

Volume flow: 60,000 m<sup>3</sup>/h,  
Pressure increase: 3,164 Pa,  
Medium temperature: 40 °C,  
Motor output: 75 kW,  
Motor speed: 1,488 min<sup>-1</sup>

Two customised low-pressure fans with area of use in a filtering plant

### Distinctive features:

Housing and drive insulation from galvanised, 100-mm steel sheet, joint Y-sections for both fans, a 3 m high splitter silencer, total height of air technology plant exceeding 8 m

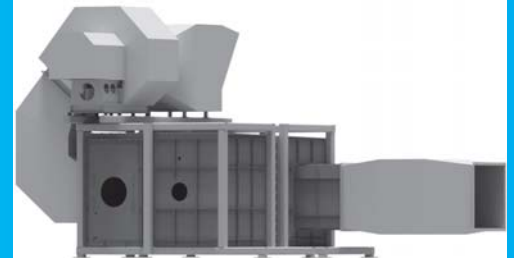

## CFL1 1000

Volume flow: 60,000 m<sup>3</sup>/h,  
Pressure increase: 2,300 Pa,  
Medium temperature: 20 °C,  
Motor output: 160 kW,  
Motor speed: 1,514 min<sup>-1</sup>

Customised low-pressure fan for process air extraction from heat exchangers

### Distinctive features:

Complete, low-sound unit with optimised air technology made from a fan in custom housing position, housing and drive insulation in stainless steel, robust duct, delivered with splitter silencer and adapters



Elektror airsystems gmbh  
Headquarters  
Hellmuth-Hirth-Str. 2  
DE-73760 Ostfildern  
Phone: +49 (0)711 31973-0  
Fax: +49 (0)711 31973-5000  
info@elektror.com

Elektror airsystems Sp. z o.o.  
Production Center  
ul. Leśna 38  
PL-41-506 Chorzów  
Phone: +48 (0)32 27765-60  
Fax: +48 (0)32 27765-61  
info@elektror.pl

