

General Description

OST15N65DRF uses advanced Oriental-Semi's patented Trident-Gate Bipolar Transistor (TGBT™) technology to provide extremely low $V_{CE(sat)}$, low gate charge, and excellent switching performance. This device is suitable for mid to high range switching frequency converters.

Features

- Advanced TGBT™ technology
- Excellent conduction and switching loss
- Excellent stability and uniformity
- Fast and soft antiparallel diode



Applications

- Induction converters
- Uninterruptible power supplies

Key Performance Parameters

Parameter	Value	Unit
$V_{CES, min} @ 25\text{ °C}$	650	V
Maximum junction temperature	175	°C
$I_C, pulse$	45	A
$V_{CE(sat), typ} @ V_{GE}=15\text{ V}$	1.65	V
Q_g	73	nC

Marking Information

Product Name	Package	Marking
OST15N65DRF	TO252	OST15N65DR

Package & Pin Information

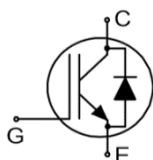

Absolute Maximum Ratings at $T_{vj}=25\text{ °C}$ unless otherwise noted

Parameter	Symbol	Value	Unit
Collector emitter voltage	V_{CES}	650	V
Gate emitter voltage	V_{GES}	± 20	V
Transient gate emitter voltage, $T_P \leq 10\ \mu s$, $D < 0.01$		± 30	V
Continuous collector current ¹⁾ , $T_C=25\text{ °C}$	I_C	30	A
Continuous collector current ¹⁾ , $T_C=100\text{ °C}$		15	A
Pulsed collector current ²⁾ , $T_C=25\text{ °C}$	$I_{C, pulse}$	45	A
Diode forward current ¹⁾ , $T_C=25\text{ °C}$	I_F	30	A
Diode forward current ¹⁾ , $T_C=100\text{ °C}$		15	A
Diode pulsed current ²⁾ , $T_C=25\text{ °C}$	$I_{F, pulse}$	45	A
Power dissipation ³⁾ , $T_C=25\text{ °C}$	P_D	250	W
Operation and storage temperature	T_{stg}, T_{vj}	-55 to 175	$^{\circ}\text{C}$
Short circuit withstand time $V_{GE}=15\text{ V}$, $V_{CC} \leq 400\text{ V}$ Allowed number of short circuits < 1000 Time between short circuits: $\geq 1.0\text{ S}$ $T_{vj}=150\text{ °C}$	tsc	10	μs

Thermal Characteristics

Parameter	Symbol	Value	Unit
IGBT thermal resistance, junction-case	$R_{\theta JC}$	0.6	$^{\circ}\text{C/W}$
Diode thermal resistance, junction-case	$R_{\theta JC}$	2.0	$^{\circ}\text{C/W}$
Thermal resistance, junction-ambient ⁴⁾	$R_{\theta JA}$	75	$^{\circ}\text{C/W}$

Electrical Characteristics at $T_{vj}=25\text{ °C}$ unless otherwise specified

Parameter	Symbol	Min.	Typ.	Max.	Unit	Test condition
Collector-emitter breakdown voltage	$V_{(BR)CES}$	650			V	$V_{GE}=0\text{ V}$, $I_C=0.5\text{ mA}$
Collector-emitter saturation voltage	$V_{CE(sat)}$		1.65	2.0	V	$V_{GE}=15\text{ V}$, $I_C=15\text{ A}$ $T_{vj}=25\text{ °C}$
			1.8		V	$V_{GE}=15\text{ V}$, $I_C=15\text{ A}$, $T_{vj}=125\text{ °C}$
			1.9			$V_{GE}=15\text{ V}$, $I_C=15\text{ A}$, $T_{vj}=175\text{ °C}$
Gate-emitter threshold voltage	$V_{GE(th)}$	4.4	5.2	6.0	V	$V_{CE}=V_{GE}$, $I_D=0.5\text{ mA}$
Diode forward voltage	V_F		1.65	2.0	V	$V_{GE}=0\text{ V}$, $I_F=15\text{ A}$ $T_{vj}=25\text{ °C}$
			1.8			$V_{GE}=0\text{ V}$, $I_F=15\text{ A}$, $T_{vj}=125\text{ °C}$
			1.9			$V_{GE}=0\text{ V}$, $I_F=15\text{ A}$, $T_{vj}=175\text{ °C}$
Gate-emitter leakage current	I_{GES}			100	nA	$V_{CE}=0\text{ V}$, $V_{GE}=20\text{ V}$
Zero gate voltage collector current	I_{CES}			10	μA	$V_{CE}=650\text{ V}$, $V_{GE}=0\text{ V}$

Dynamic Characteristics

Parameter	Symbol	Min.	Typ.	Max.	Unit	Test condition
Input capacitance	C_{ies}		2015		pF	$V_{GE}=0\text{ V}$, $V_{CE}=25\text{ V}$, $f=100\text{ kHz}$
Output capacitance	C_{oes}		80		pF	
Reverse transfer capacitance	C_{res}		41		pF	
Turn-on delay time	$t_{d(on)}$		50		ns	$V_{GE}=15\text{ V}$, $V_{CC}=400\text{ V}$, $R_G=10\ \Omega$, $I_C=15\text{ A}$
Rise time	t_r		36		ns	
Turn-off delay time	$t_{d(off)}$		143		ns	
Fall time	t_f		94		ns	
Turn-on energy	E_{on}		0.62		mJ	
Turn-off energy	E_{off}		0.11		mJ	

Gate Charge Characteristics

Parameter	Symbol	Min.	Typ.	Max.	Unit	Test condition
Total gate charge	Q_g		73		nC	$V_{GE}=15\text{ V}$, $V_{CC}=520\text{ V}$, $I_C=15\text{ A}$
Gate-emitter charge	Q_{ge}		22		nC	
Gate-collector charge	Q_{gc}		36		nC	

Body Diode Characteristics

Parameter	Symbol	Min.	Typ.	Max.	Unit	Test condition
Diode reverse recovery time	t_{rr}		94		ns	$V_R=400\text{ V}$, $I_F=15\text{ A}$, $di_F/dt=500\text{ A}/\mu\text{s}$ $T_{vj}=25\text{ }^\circ\text{C}$
Diode reverse recovery charge	Q_{rr}		1.2		μC	
Diode peak reverse recovery current	I_{rrm}		21.7		A	

Note

- 1) Calculated continuous current based on maximum allowable junction temperature.
- 2) Repetitive rating; pulse width limited by max. junction temperature.
- 3) P_d is based on max. junction temperature, using junction-case thermal resistance.
- 4) The value of $R_{\theta JA}$ is measured with the device mounted on 1 in square FR-4 board with 2oz. Copper, in a still air environment with $T_a=25\text{ }^\circ\text{C}$.

Electrical Characteristics Diagrams

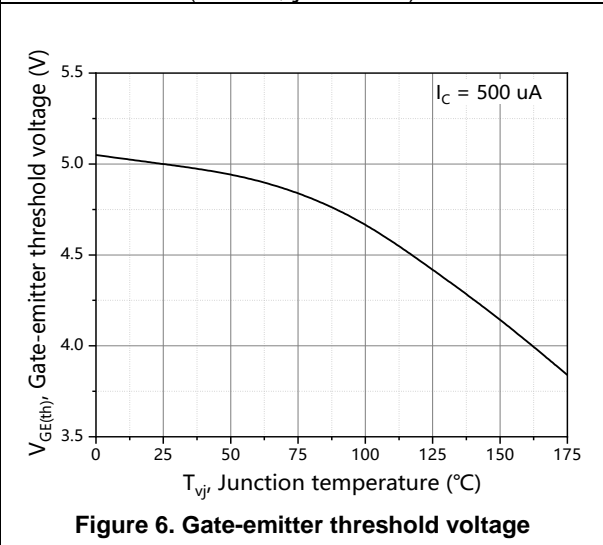
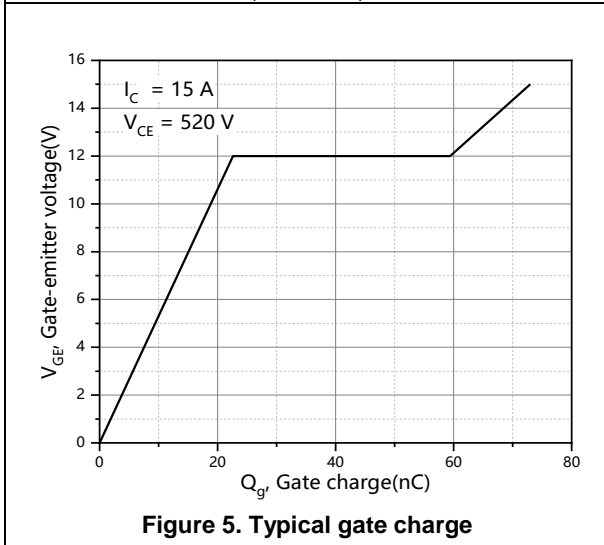
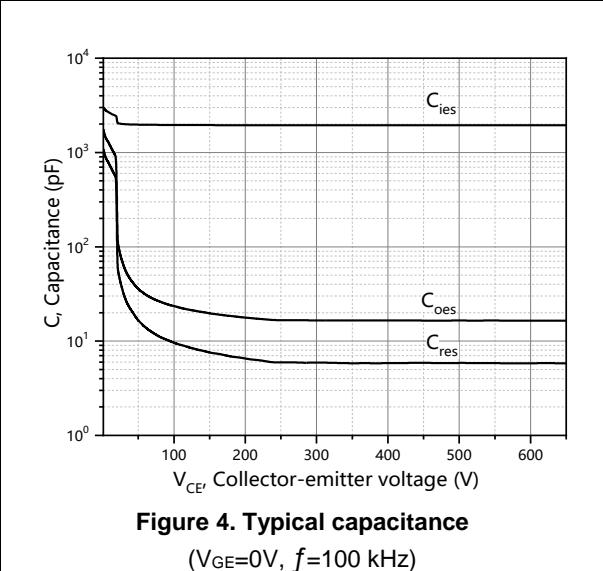
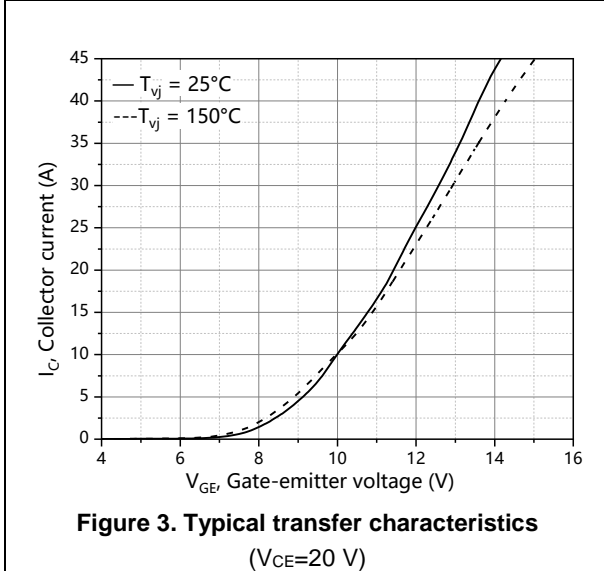
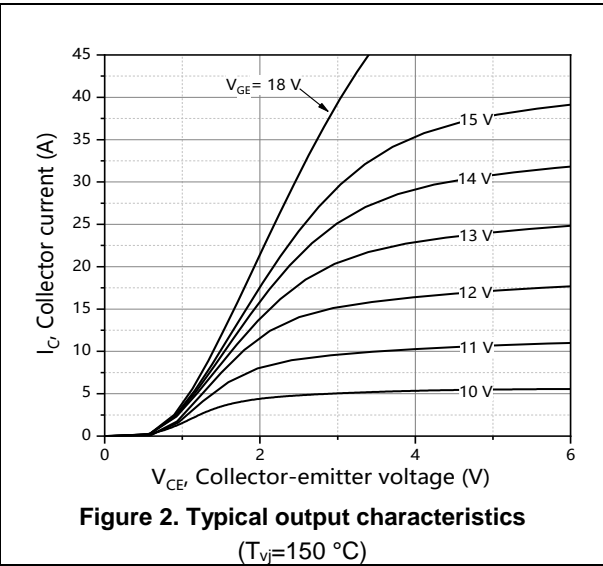
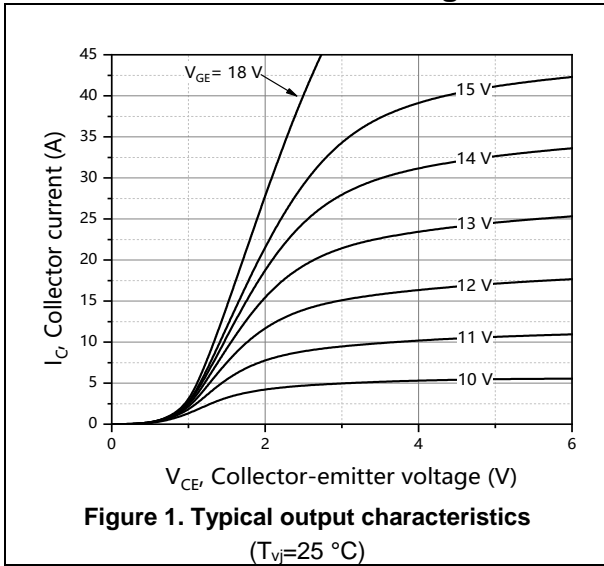

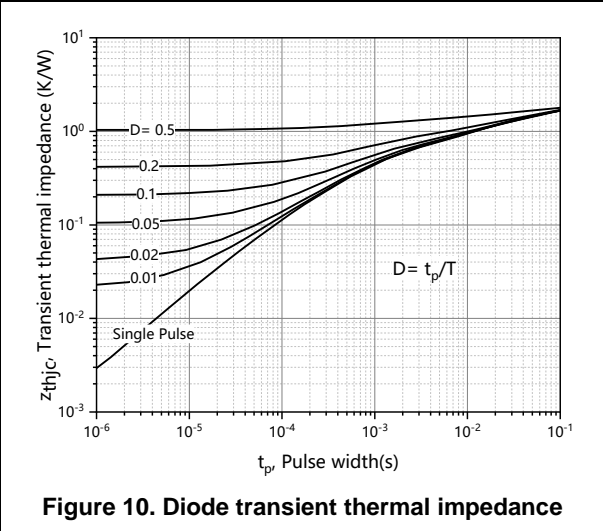
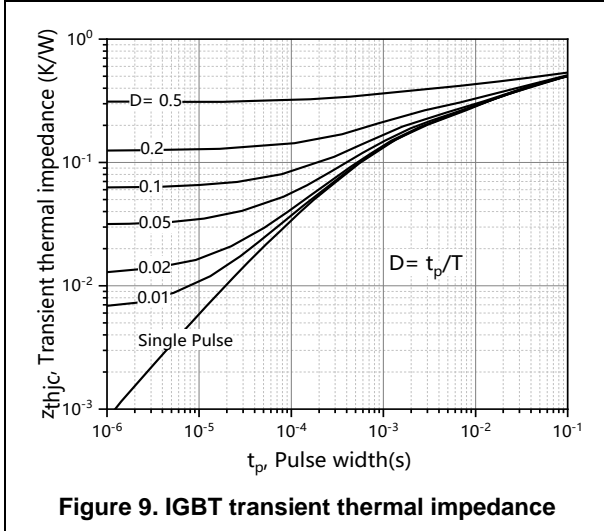
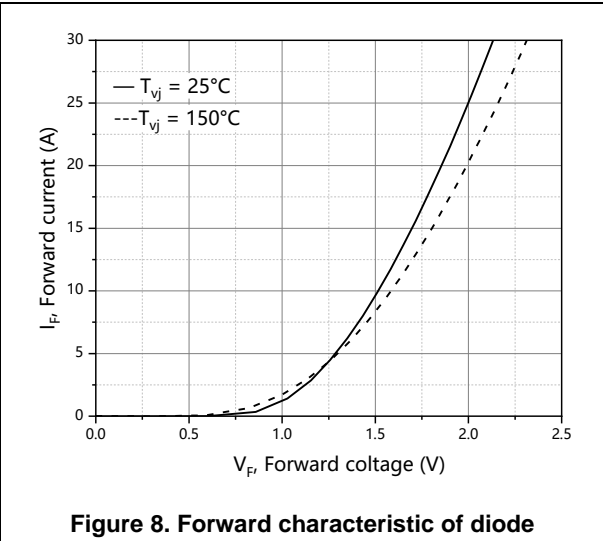
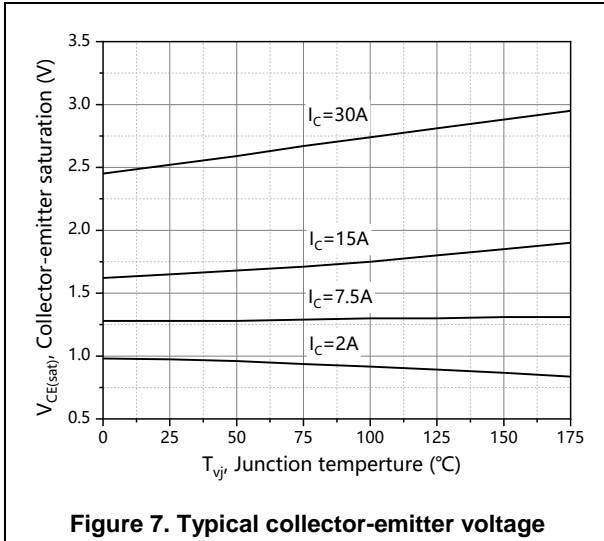

Package Information

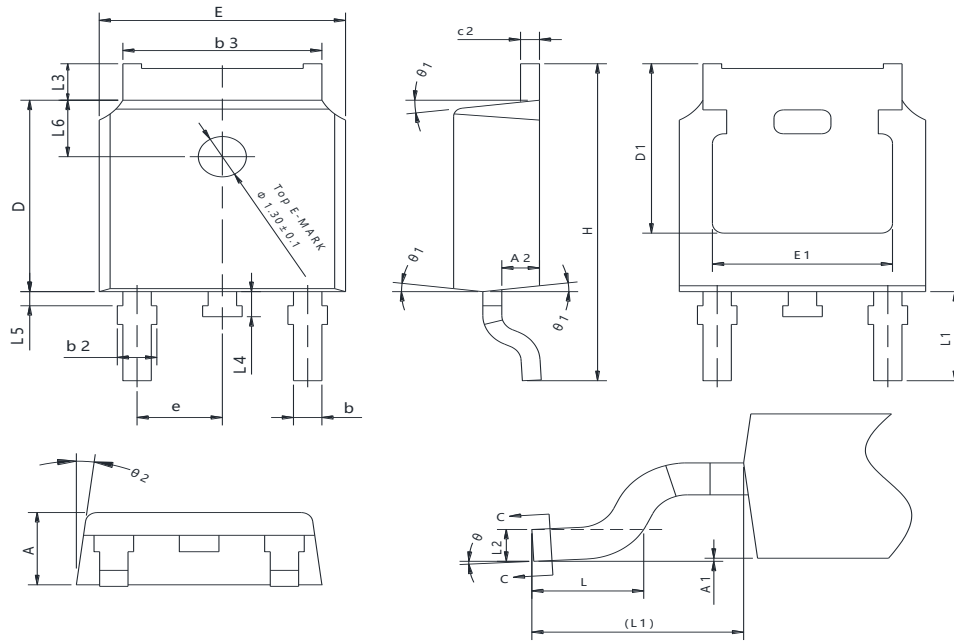

Symbol	mm		
	Min	Nom	Max
A	2.20	2.30	2.38
A1	0.00	-	0.10
A2	0.90	1.01	1.10
b	0.72	-	0.85
b1	0.71	0.76	0.81
b2	0.72	-	0.90
b3	5.13	5.33	5.46
c	0.47	-	0.60
c1	0.46	0.51	0.56
c2	0.47	-	0.60
D	6.00	6.10	6.20
D1	5.25	-	-
E	6.50	6.60	6.70
E1	4.70	-	-
e	2.186	2.286	2.386
H	9.80	10.10	10.40
L	1.40	1.50	1.70
L1	2.90 REF		
L2	0.508 BSC		
L3	0.90	-	1.25
L4	0.60	0.80	1.00
L5	0.15	-	0.75
L6	1.80 REF		
θ	0°	-	8°
θ_1	5°	7°	9°
θ_2	5°	7°	9°

Version 1: TO252-J package outline dimension

Ordering Information

Package Type	Units/ Reel	Reels/ Inner Box	Units/ Inner Box	Inner Boxes/ Carton Box	Units/ Carton Box
TO252-J	2500	2	5000	5	25000

Product Information

Product	Package	Pb Free	RoHS	Halogen Free
OST15N65DRF	TO252	yes	yes	yes

Legal Disclaimer

The information given in this document shall in no event be regarded as a guarantee of conditions or characteristics. With respect to any examples or hints given herein, any typical values stated herein and/or any information regarding the application of the device, Oriental Semiconductor hereby disclaims any and all warranties and liabilities of any kind, including without limitation, warranties of non-infringement of intellectual property rights of any third party.

For further information on technology, delivery terms and conditions and prices, please contact the Oriental Semiconductor sales representatives (www.orientalsemi.com).

© Oriental Semiconductor Co.,Ltd. All Rights Reserved 