

General Description

OST80N65HMF uses advanced Oriental-Semi's patented Trident-Gate Bipolar Transistor (TGBT™) technology to provide extremely low $V_{CE(sat)}$, low gate charge, and excellent switching performance. This device is suitable for mid to high range switching frequency converters.

Features

- Advanced TGBT™ technology
- Excellent conduction and switching loss
- Excellent stability and uniformity
- Fast and soft antiparallel diode



Applications

- Induction converters
- Uninterruptible power supplies

Key Performance Parameters

Parameter	Value	Unit
$V_{CES, min} @ 25^{\circ}C$	650	V
Maximum junction temperature	175	$^{\circ}C$
$I_C, pulse$	320	A
$V_{CE(sat), typ} @ V_{GE}=15V$	1.6	V
Q_g	172	nC

Marking Information

Product Name	Package	Marking
OST80N65HMF	TO247	OST80N65HM

Package & Pin Information

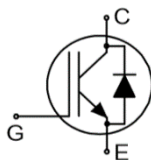

Absolute Maximum Ratings at $T_{vj}=25^{\circ}\text{C}$ unless otherwise noted

Parameter	Symbol	Value	Unit
Collector emitter voltage	V_{CES}	650	V
Gate emitter voltage	V_{GES}	± 20	V
Transient gate emitter voltage, $T_P \leq 10\mu\text{s}$, $D < 0.01$		± 30	V
Continuous collector current ¹⁾ , $T_C=25^{\circ}\text{C}$	I_C	114	A
Continuous collector current ¹⁾ , $T_C=100^{\circ}\text{C}$		80	A
Pulsed collector current ²⁾ , $T_C=25^{\circ}\text{C}$	$I_{C, pulse}$	320	A
Diode forward current ¹⁾ , $T_C=25^{\circ}\text{C}$	I_F	114	A
Diode forward current ¹⁾ , $T_C=100^{\circ}\text{C}$		80	A
Diode pulsed current ²⁾ , $T_C=25^{\circ}\text{C}$	$I_{F, pulse}$	320	A
Power dissipation ³⁾ , $T_C=25^{\circ}\text{C}$	P_D	395	W
Power dissipation ³⁾ , $T_C=100^{\circ}\text{C}$		197	W
Operation and storage temperature	T_{stg}, T_{vj}	-55 to 175	$^{\circ}\text{C}$

Thermal Characteristics

Parameter	Symbol	Value	Unit
IGBT thermal resistance, junction-case	$R_{\theta JC}$	0.38	$^{\circ}\text{C/W}$
Diode thermal resistance, junction-case	$R_{\theta JC}$	0.68	$^{\circ}\text{C/W}$
Thermal resistance, junction-ambient ⁴⁾	$R_{\theta JA}$	40	$^{\circ}\text{C/W}$

Electrical Characteristics at $T_{vj}=25^{\circ}\text{C}$ unless otherwise specified

Parameter	Symbol	Min.	Typ.	Max.	Unit	Test condition
Collector-emitter breakdown voltage	$V_{(BR)CES}$	650			V	$V_{GE}=0\text{ V}$, $I_C=0.5\text{ mA}$
Collector-emitter saturation voltage	$V_{CE(sat)}$		1.6	2.0	V	$V_{GE}=15\text{ V}$, $I_C=80\text{ A}$ $T_{vj}=25^{\circ}\text{C}$
			1.8		V	$V_{GE}=15\text{ V}$, $I_C=80\text{ A}$, $T_{vj}=125^{\circ}\text{C}$
			1.9			$V_{GE}=15\text{ V}$, $I_C=80\text{ A}$, $T_{vj}=175^{\circ}\text{C}$
Gate-emitter threshold voltage	$V_{GE(th)}$	3.5	4.5	5.5	V	$V_{CE}=V_{GE}$, $I_D=0.5\text{ mA}$
Diode forward voltage	V_F		1.85	2.0	V	$V_{GE}=0\text{ V}$, $I_F=80\text{ A}$ $T_{vj}=25^{\circ}\text{C}$
			1.65			$V_{GE}=0\text{ V}$, $I_F=80\text{ A}$, $T_{vj}=125^{\circ}\text{C}$
			1.6			$V_{GE}=0\text{ V}$, $I_F=80\text{ A}$, $T_{vj}=175^{\circ}\text{C}$
Gate-emitter leakage current	I_{GES}			100	nA	$V_{CE}=0\text{ V}$, $V_{GE}=20\text{ V}$
Zero gate voltage collector current	I_{CES}			10	μA	$V_{CE}=650\text{ V}$, $V_{GE}=0\text{ V}$

Dynamic Characteristics

Parameter	Symbol	Min.	Typ.	Max.	Unit	Test condition
Input capacitance	C_{ies}		8854		pF	$V_{GE}=0\text{ V}$, $V_{CE}=25\text{ V}$, $f=100\text{ kHz}$
Output capacitance	C_{oes}		233		pF	
Reverse transfer capacitance	C_{res}		12		pF	
Turn-on delay time	$t_{d(on)}$		90		ns	$V_{GE}=15\text{ V}$, $V_{CC}=400\text{ V}$, $R_G=10\ \Omega$, $I_C=80\text{ A}$
Rise time	t_r		149		ns	
Turn-off delay time	$t_{d(off)}$		199		ns	
Fall time	t_f		78		ns	
Turn-on energy	E_{on}		3.7		mJ	
Turn-off energy	E_{off}		1.14		mJ	
Turn-on delay time	$t_{d(on)}$		81		ns	$V_{GE}=15\text{ V}$, $V_{CC}=400\text{ V}$, $R_G=10\ \Omega$, $I_C=40\text{ A}$
Rise time	t_r		74		ns	
Turn-off delay time	$t_{d(off)}$		243		ns	
Fall time	t_f		26		ns	
Turn-on energy	E_{on}		1.2		mJ	
Turn-off energy	E_{off}		0.51		mJ	

Gate Charge Characteristics

Parameter	Symbol	Min.	Typ.	Max.	Unit	Test condition
Total gate charge	Q_g		172		nC	$V_{GE}=15\text{ V}$, $V_{CC}=520\text{ V}$, $I_C=80\text{ A}$
Gate-emitter charge	Q_{ge}		79		nC	
Gate-collector charge	Q_{gc}		31		nC	

Body Diode Characteristics

Parameter	Symbol	Min.	Typ.	Max.	Unit	Test condition
Diode reverse recovery time	t_{rr}		158		ns	$V_R=400\text{ V}$, $I_F=80\text{ A}$, $di_F/dt=500\text{ A}/\mu\text{s}$
Diode reverse recovery charge	Q_{rr}		948		nC	
Diode peak reverse recovery current	I_{rrm}		15		A	

Note

- 1) Calculated continuous current based on maximum allowable junction temperature.
- 2) Repetitive rating; pulse width limited by max. junction temperature.
- 3) P_d is based on max. junction temperature, using junction-case thermal resistance.
- 4) The value of $R_{\theta JA}$ is measured with the device mounted on 1 in² FR-4 board with 2oz. Copper, in a still air environment with $T_a=25\text{ }^\circ\text{C}$.

Electrical Characteristics Diagrams

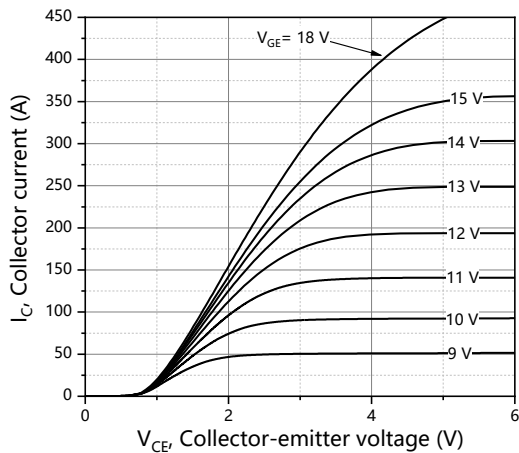

Figure 1. Typical output characteristics
($T_{vj}=25^{\circ}\text{C}$)

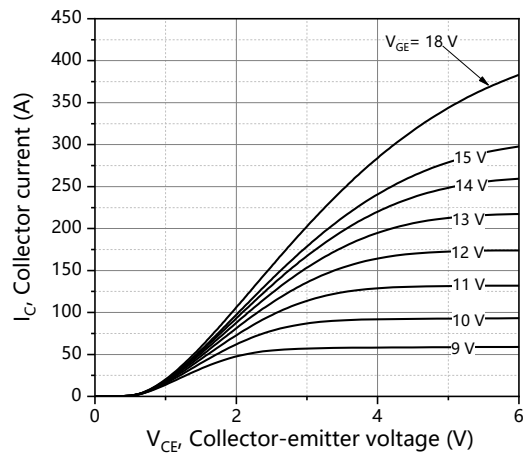

Figure 2. Typical output characteristics
($T_{vj}=150^{\circ}\text{C}$)

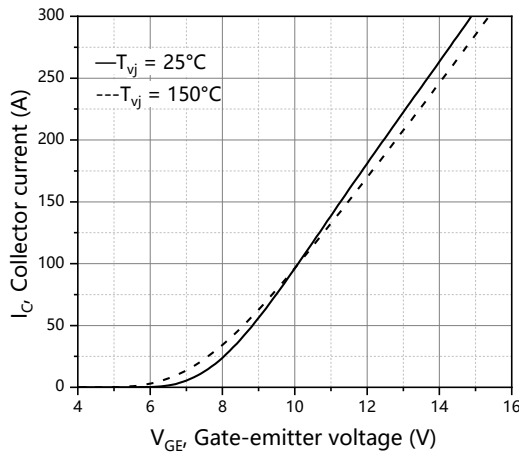

Figure 3. Typical transfer characteristics
($V_{ce}=20\text{V}$)

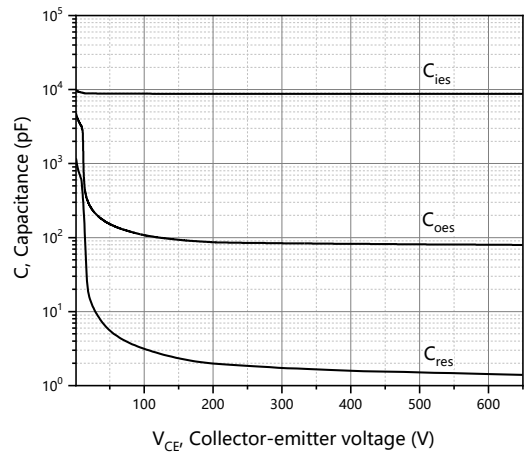

Figure 4. Typical capacitance
($V_{ge}=0\text{V}$, $f=100\text{ kHz}$)

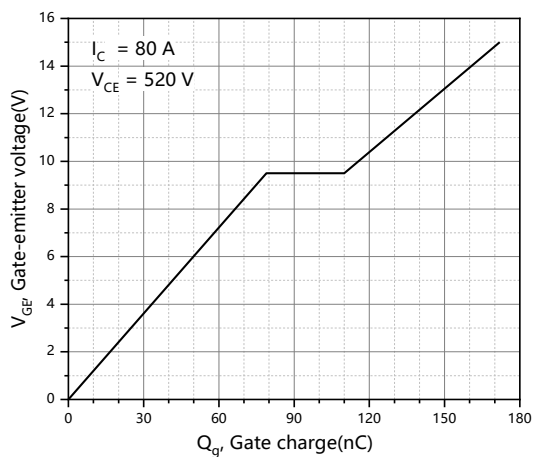

Figure 5. Typical gate charge

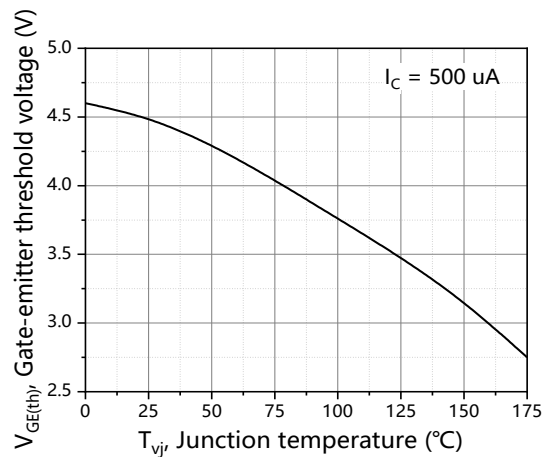
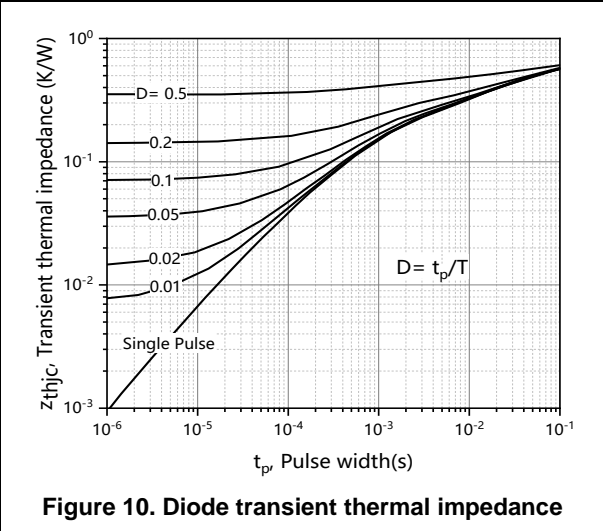
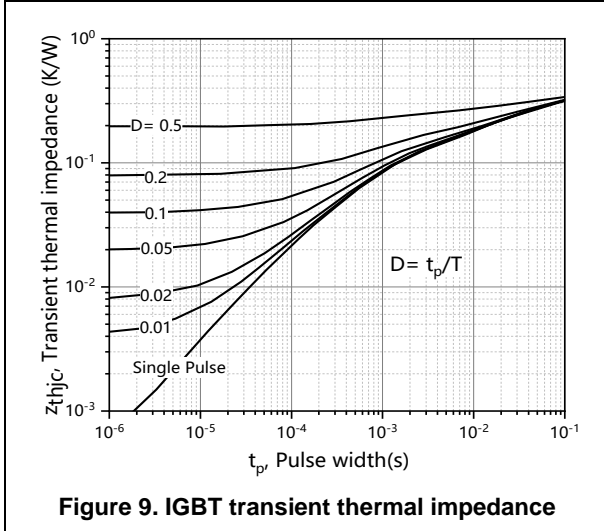
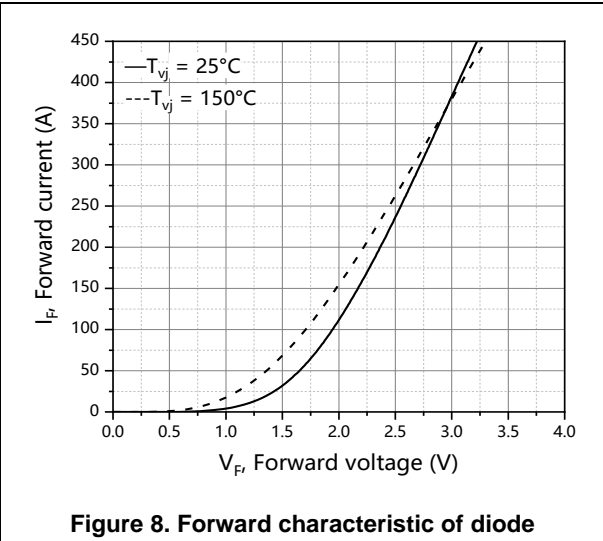
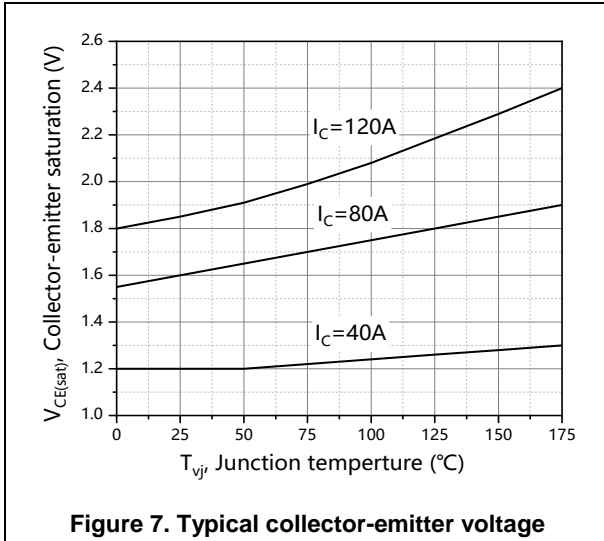
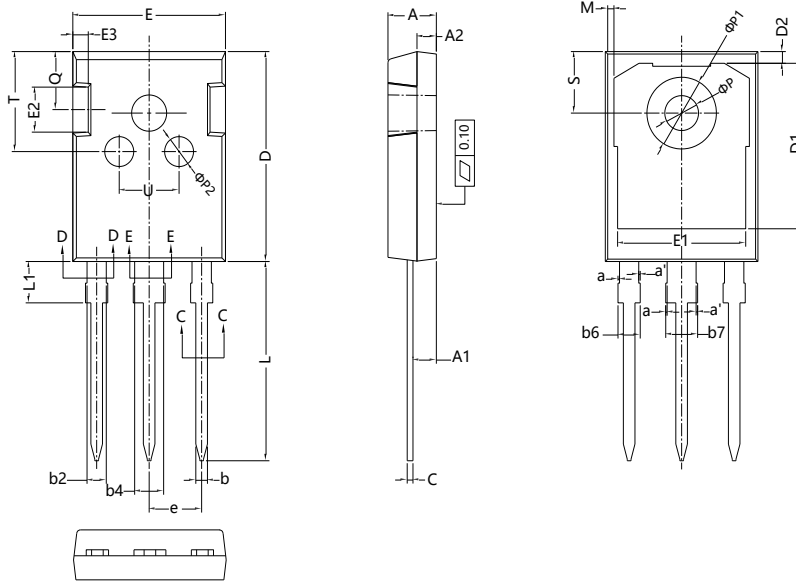

Figure 6. Gate-emitter threshold voltage



Package Information



Symbol	mm		
	Min	Nom	Max
A	4.90	5.00	5.10
A1	2.31	2.41	2.51
A2	1.90	2.00	2.10
a	0.00	-	0.15
a'	0.00	-	0.15
b	1.16	-	1.26
b2	1.96	-	2.06
b4	2.96	-	3.06
b6	-	-	2.25
b7	-	-	3.25
c	0.59	-	0.66
c1	0.58	0.60	0.62
D	20.90	21.00	21.10
D1	16.25	16.55	16.85
D2	1.05	1.17	1.35
E	15.70	15.80	15.90
E1	13.10	13.30	13.50
E2	4.40	4.50	4.60
E3	1.50	1.60	1.70
e	5.436 BSC		
L	19.80	19.92	20.10
L1	-	-	4.30
M	0.35	-	0.95
P	3.40	3.50	3.60
P1	7.00	-	7.40
P2	2.40	2.5	2.6
Q	5.60	-	6.0
S	6.05	6.15	6.25
T	9.8	-	10.20
U	6.00	-	6.40

Version 1: TO247-J package outline dimension

Ordering Information

Package Type	Units/ Tube	Tubes/ Inner Box	Units/ Inner Box	Inner Boxes/ Carton Box	Units/ Carton Box
TO247-J	30	20	600	4	2400

Product Information

Product	Package	Pb Free	RoHS	Halogen Free
OST80N65HMF	TO247	yes	yes	yes

Legal Disclaimer

The information given in this document shall in no event be regarded as a guarantee of conditions or characteristics. With respect to any examples or hints given herein, any typical values stated herein and/or any information regarding the application of the device, Oriental Semiconductor hereby disclaims any and all warranties and liabilities of any kind, including without limitation, warranties of non-infringement of intellectual property rights of any third party.

For further information on technology, delivery terms and conditions and prices, please contact the Oriental Semiconductor sales representatives (www.orientalsemi.com).

© Oriental Semiconductor Co.,Ltd. All Rights Reserved 