



HEALTHCARE RISK PREVENTION SOLUTIONS

Hospitals
Aged Care
Medical Clinics
Research Facilities
Accessible Facilities

Our extensive experience and know-how enable us to offer a comprehensive suite of products and solutions for Health and Aged care applications. We work closely with all the key stakeholders in the health care sector, which gives us a thorough understanding of the critical elements needed to mitigate cross infection and microbial control.

VERIFIED BY WORLD-LEADING INSPECTION COMPANY SGS & TUV SUD





317A

SAFETY GRAB BAR

- Stainless steel 304
- Dia 32mm/38mm
- Available size 300mm/450mm/600mm/900mm
- Customized size is available on customer's requirement
- Loaded 200kg
- SSS/PSS Finishes
- Incl. fixing screws

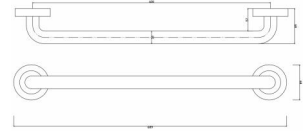

317.8927

SWING UP SAFETY GRAB BAR

- Stainless steel 304
- Dia 32mm
- Length 700mm
- Loaded 200kg
- SSS/PSS finishes
- Incl. fixing screws

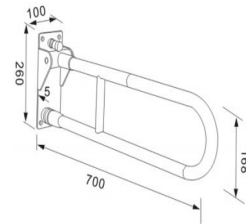

317.8812

U-SHAPE SAFETY GRAB BAR

- Stainless steel 304
- Dia 32mm
- Length 600mm
- Loaded 200kg
- SSS/PSS finishes
- Incl. fixing screws

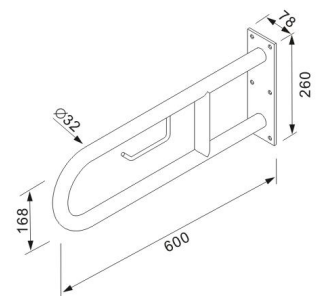



317.8928

L-SHAPE SAFETY GRAB BAR

- Stainless steel 304
- Dia 32mm
- Length 700×700mm
- Loaded 200kg
- SSS/PSS finishes
- Incl. fixing screws

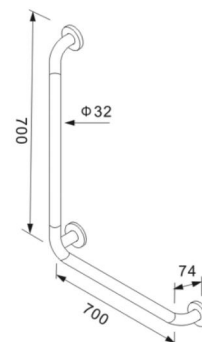

317.8929

SAFETY GRAB BAR

- Stainless steel 304
- Dia 32mm
- Length 550mm
- Width 600mm
- Loaded 200kg
- SSS/PSS finishes
- Incl. fixing screws

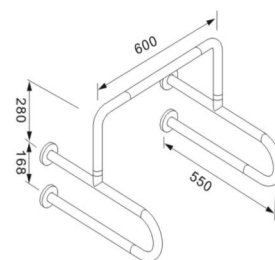

317.8926

SAFETY GRAB BAR

- Stainless steel 304
- Dia 32mm
- Length 635mm
- Loaded 200kg
- SSS/PSS finishes
- Incl. fixing screws

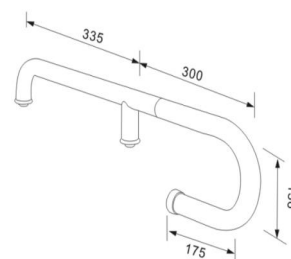

317.8819

SAFETY GRAB BAR

- Stainless steel 304
- Dia 32mm
- Length 450×450mm
- Loaded 200kg
- SSS finish
- Incl. fixing screws

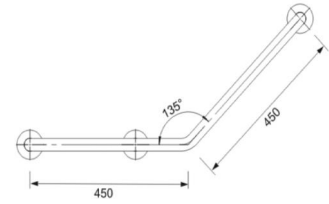

317.8811

SAFETY GRAB BAR

- Stainless steel 304
- Dia 32mm
- Length 600mm
- Height 700mm
- Loaded 200kg
- SSS finish
- Incl. fixing screws

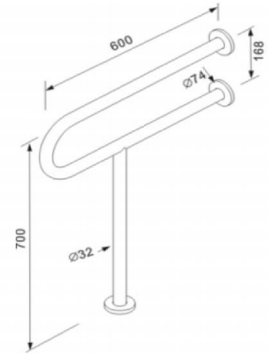

317.8813

SAFETY GRAB BAR

- Stainless steel 304
- Dia 32mm
- Length 600mm
- Loaded 200kg
- SSS finish
- Incl. fixing screws

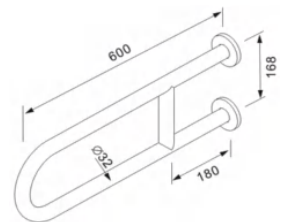

**317.8819****SAFETY GRAB BAR**

- Stainless steel 304
- Dia 32mm
- Length 550mm
- Height 700mm
- Loaded 200kg
- SSS finish
- Incl. fixing screws

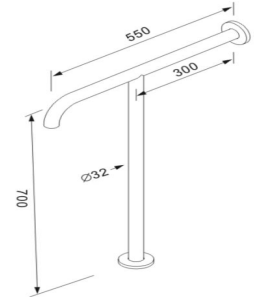
**317.8816****SAFETY GRAB BAR**

- Stainless steel 304
- Dia 32mm
- Length 550mm
- Height 700mm
- Loaded 200kg
- SSS finish
- Incl. fixing screws

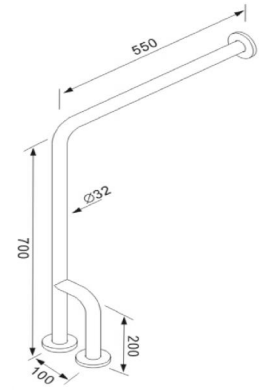
**317.8818****SAFETY GRAB BAR**

- Stainless steel 304
- Dia 32mm
- Length 700×500mm
- Loaded 200kg
- SSS finish
- Incl. fixing screws

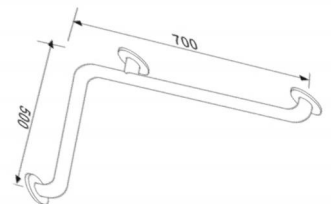



317.8821

SAFETY GRAB BAR

- Stainless steel 304
- Dia 32mm
- Length 550mm
- Width 600
- Loaded 200kg
- SSS finish
- Incl. fixing screws

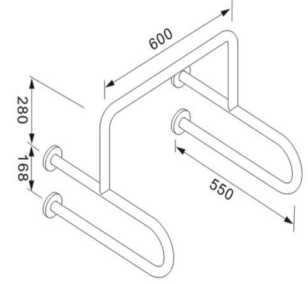

317A.000

SAFETY GRAB BAR WITH SHOWER HOLDER

- Stainless steel 304
- Dia 32mm/38mm
- Available size 300mm/450mm/600mm/900mm
- Customized size ia available on customer's requirement
- Loaded 200kg
- SSS/PSS finishes
- Incl. fixing screws

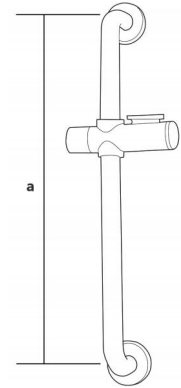

317A7070

SAFETY GRAB BAR WITH SHOWER HOLDER

- Stainless steel 304
- Dia 32mm/38mm
- Length 700×700mm
- Customized size ia available on customer's requirement
- Loaded 200kg
- SSS finishes
- Incl. fixing screws

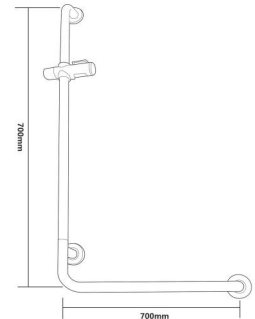

**317A9070****SAFETY GRAB BAR WITH SHOWER HOLDER**

- Stainless steel 304
- Dia 32mm/38mm
- Length 900×700mm
- Customized size is available on customer's requirement
- Loaded 200kg
- SSS finishes
- Incl. fixing screws

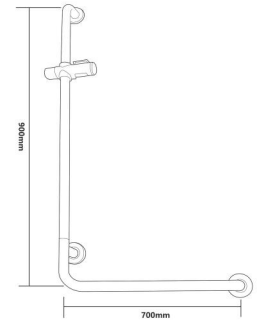
**317.8810****SAFETY GRAB BAR**

- Available size 300mm/450mm/600mm/900mm
- Customized size is available on customer's requirement
- Loaded 200kg
- White color
- Incl. fixing screws

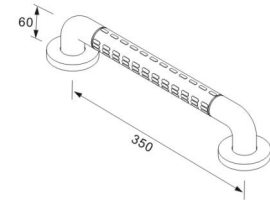
**317.8810****FLOOR U-SHAPE SAFETY GRAB BAR**

- Compounding of nylon & aluminum
- White color

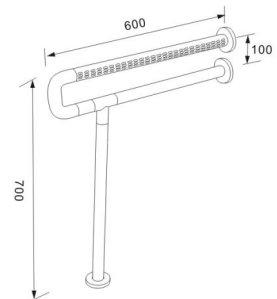



317.8852

135° SAFETY GRAB BAR

- Compounding of nylon & aluminum
- White color

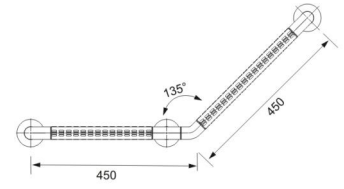

317.8870

TOILET SAFETY GRAB BAR

- Compounding of nylon & aluminum
- White color

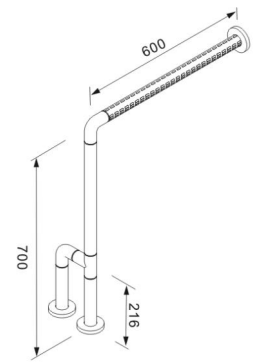

317.8850

TOILET SAFETY GRAB BAR

- Compounding of nylon & aluminum
- White color

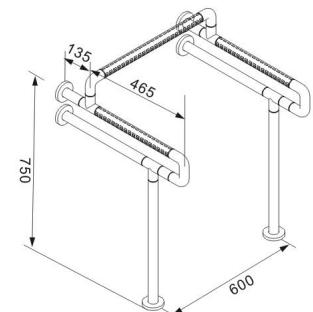



317.8849

UPTURN STRAP SUPPORT SAFETY GRAB BAR

- Compounding of nylon & aluminum
- White color

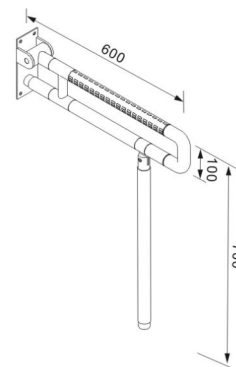

317.8808

L-SHAPE SAFETY GRAB BAR

- Compounding of nylon & aluminum
- White color

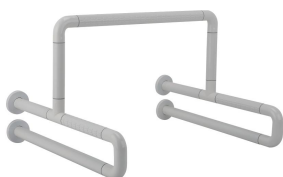
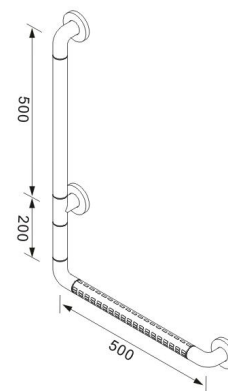

317.8806

URINAL SAFETY GRAB BAR

- Compounding of nylon & aluminum
- White color

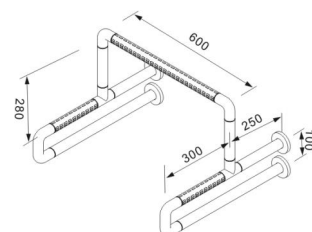



317.8807

URINAL SAFETY GRAB BAR

- Compounding of nylon & aluminum
- White color

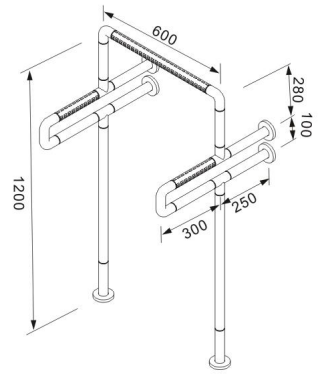

317.8887

UPTURNED BATH CHAIR

- Compounding of nylon & aluminum
- White color

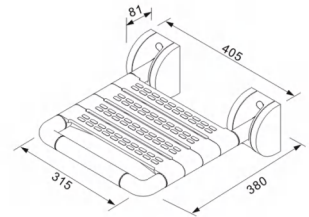

317.8853

UPTURNED BATH CHAIR

- Compounding of nylon & aluminum
- White color

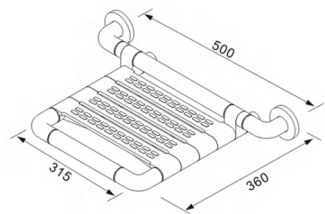



317.8890

BATHROOM MIRROR

- Compounding of nylon & aluminum
- White color

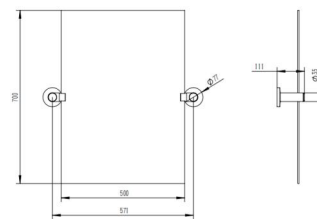

317.8891

BATHROOM MIRROR

- 304 stainless steel Silver-gilt glass
- White color

