

Automatic intelligent Moisture Analyzer



USER MANUAL

# CATALOG

|                                      |    |
|--------------------------------------|----|
| <b>FIRST:Introduction</b> .....      | 01 |
| 1.1 Security                         |    |
| 1.2 Product composition              |    |
| <b>SECOND:Installation</b> .....     | 03 |
| 2.1 Standard packing list            |    |
| 2.2 Operation requirements           |    |
| 2.3 Installation of fittings         |    |
| <b>THIRD:Home Page</b> .....         | 04 |
| 3.1 Start Page                       |    |
| 3.2 Test Page                        |    |
| <b>FOURTH:Menu</b> .....             | 05 |
| 4.1 Parameters Setting               |    |
| 4.2 History                          |    |
| 4.3 Printer Setting                  |    |
| 4.4 Calibration                      |    |
| 4.5 Language                         |    |
| 4.6 System Setting                   |    |
| 4.7 System Information               |    |
| <b>FIFTH: Assembly Drawing</b> ..... | 12 |
| <b>SIXTH: Automatic Open</b> .....   | 13 |
| 6.1 Functions                        |    |
| 6.2 Intelligent                      |    |
| 6.3 Notes                            |    |
| <b>SEVENTH:Tips</b> .....            | 14 |
| <b>EIGHTTH:Option</b> .....          | 14 |
| <b>NINETH:Schedule</b> .....         | 15 |
| <b>TENTH:Guarantee</b> .....         | 16 |

## First: Instruction

### 1.1 Security

Please reading the following before you use the Moisture analyzer:



- a. The instrument can use for test the moisture of the sample,each improper operation may result in personal injury and equipment damage
- b. Please access the AC power accordance with the manual;



- c. Please make sure the power cord does not interfere with people action;
- d. Do not use the instrument under the hazardous,wet or unstable environment ;
- e. Unplug the power before you clean the analyzer;
- f. lease keep enough space around the instrument,and keep the top of the space at least 1m;
- g. During a special experiment, please wear protective equipment by yourself;
- h. Please do not change the instrument's components and any other aspects.Maintenance of this equipment by the factory authorized professionals.



- Moisture analyzer use Halogen lamp.*
- i. Do not put the flammable materials around the instrument;
  - j. Do not touch the halogen lamp when it on working.  
*Special attention to the dangers of some sample;*



- k. Before you test the moisture of dangerous good,pleaes take Full investigation.

*Inflammable and explosive materials:Heating the inflammable and explosive materials will produce flammable gases or vapors, so need to lower the temperature in a dry environment. In case of fire or explosion.*

*Toxic and corrosive substance: Keep the samples of toxic or corrosive ingredients in well-ventilated environment.*

Above the sample test will be particularly careful, for any damage caused by your own risk

## 1.2.Product composition

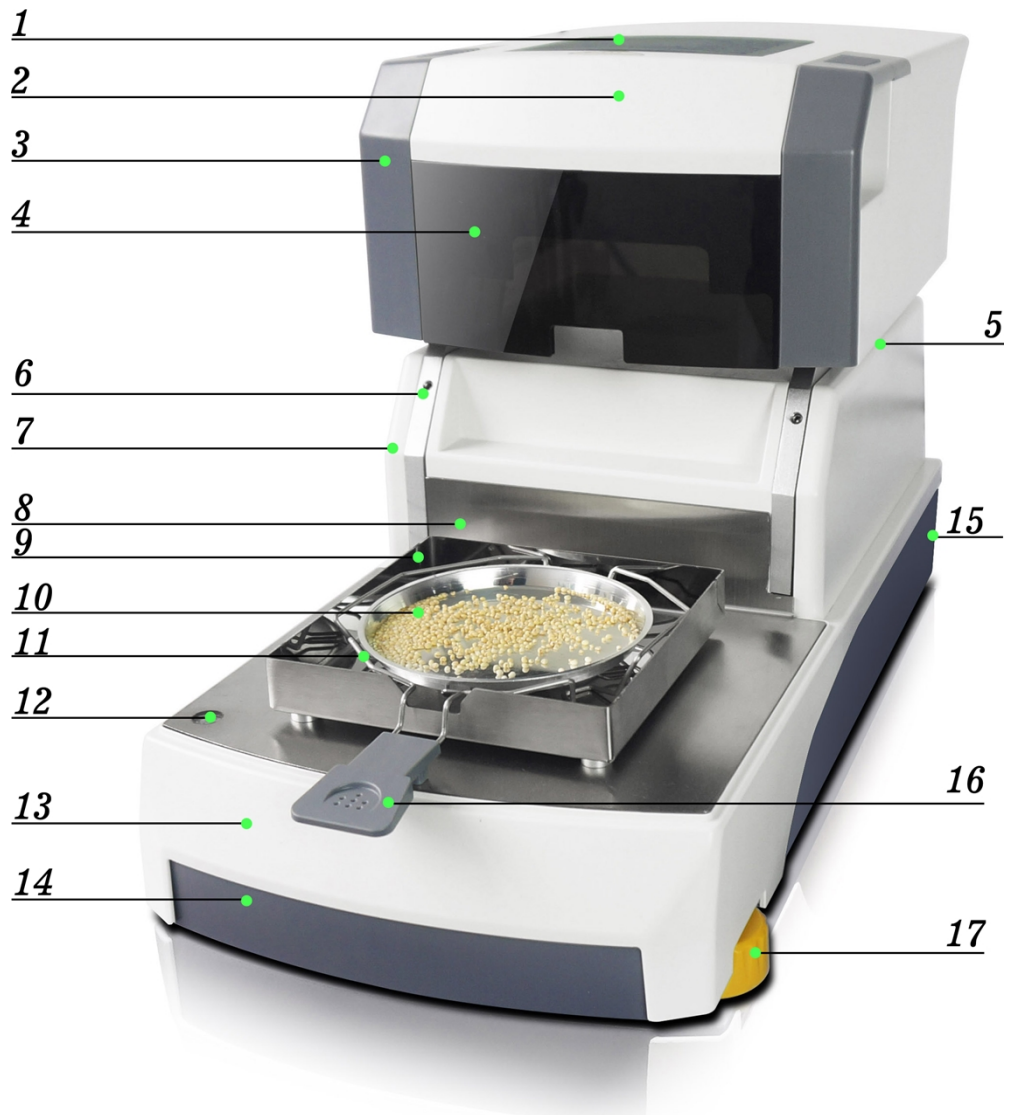

(15)

- |                         |                     |                      |                         |
|-------------------------|---------------------|----------------------|-------------------------|
| 1. Cooling window       | 2. Upper Cover      | 3. Decorative pieces | 4. Window               |
| 5. Cooling Fan          | 6. Mechanical arm   | 7. Back Cover        | 8. Stainless steel tray |
| 9. Under tray           | 10. Sample Pan      | 11. Triangle bracket | 12. Lever               |
| 13. Host Upper Shell    | 14. Host Down Shell | 15. Interface        |                         |
| 16. Sample tray bracket | 17. Adjust Feet     |                      |                         |

## Second:Installation

2.1 Please check whether the packaging and accessories is complete when you open it.

| Standard                    | Quantity | Note  |
|-----------------------------|----------|-------|
| Moisture Analyzer Mainframe | 1 set    |       |
| Wind Cover                  | 1 piece  |       |
| The sample pan holder       | 1 piece  |       |
| Tray handle                 | 1 piece  |       |
| Power cord                  | 1 piece  |       |
| Aluminum sample pan         | 1 set    | 80pcs |
| 100g standard weight        | 1 piece  |       |
| Product Manual              | 1 piece  |       |
| Product certification       | 1 piece  |       |
| Warranty card               | 1 piece  |       |
| Communication Cable         | 1 piece  |       |

### 2.2 Operating Requirement



Operating table should be stable

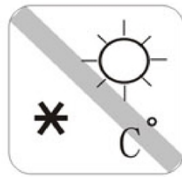

Temperature stable, dry, without strong vibration, without strong magnetic field.



good ventilation of the environment

### 2.3 Installation of accessories

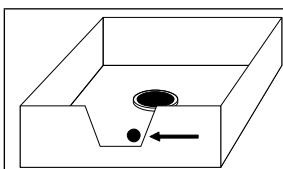

Place the wind cover, aligned holes.

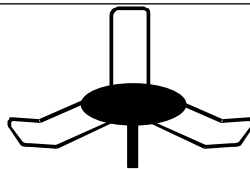

Place the sample pan holder, rotate until positioning.

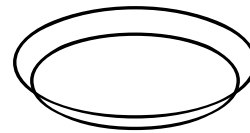

Put the aluminum sample pan on the bracket.

### Third: Home Page

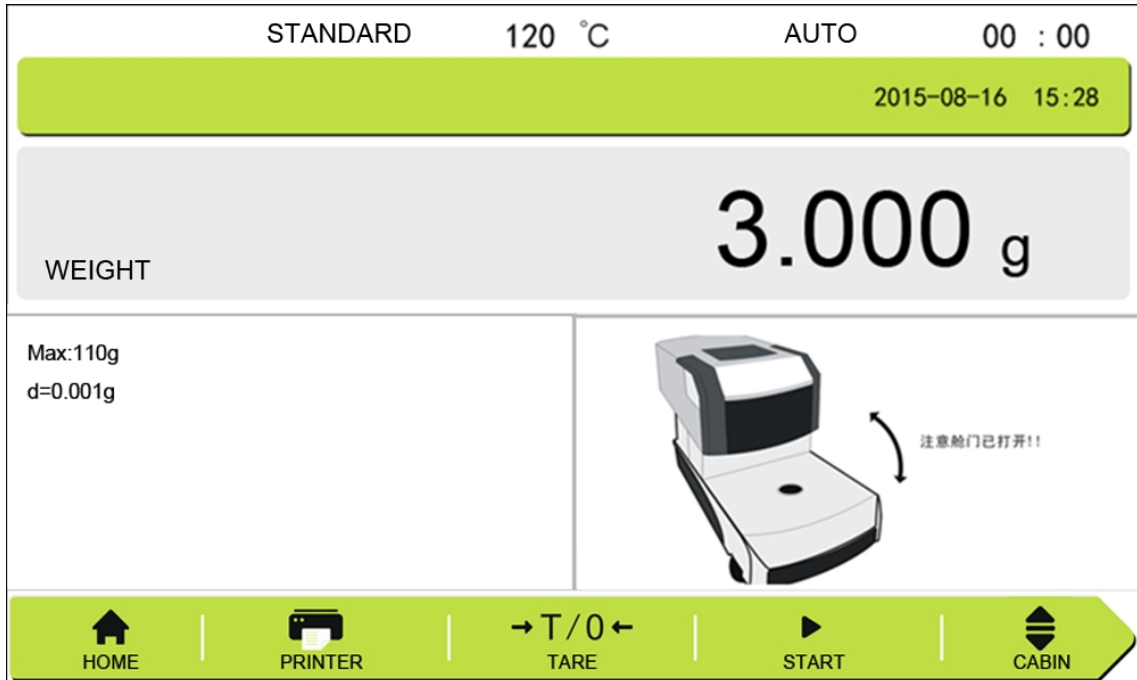

#### 3.1 Start Page

Turn on the instrument will enter the start page.

Print: Print the history of the testing;

Tare: Keep the 0.000 before weighing;

Start: Start the testing.

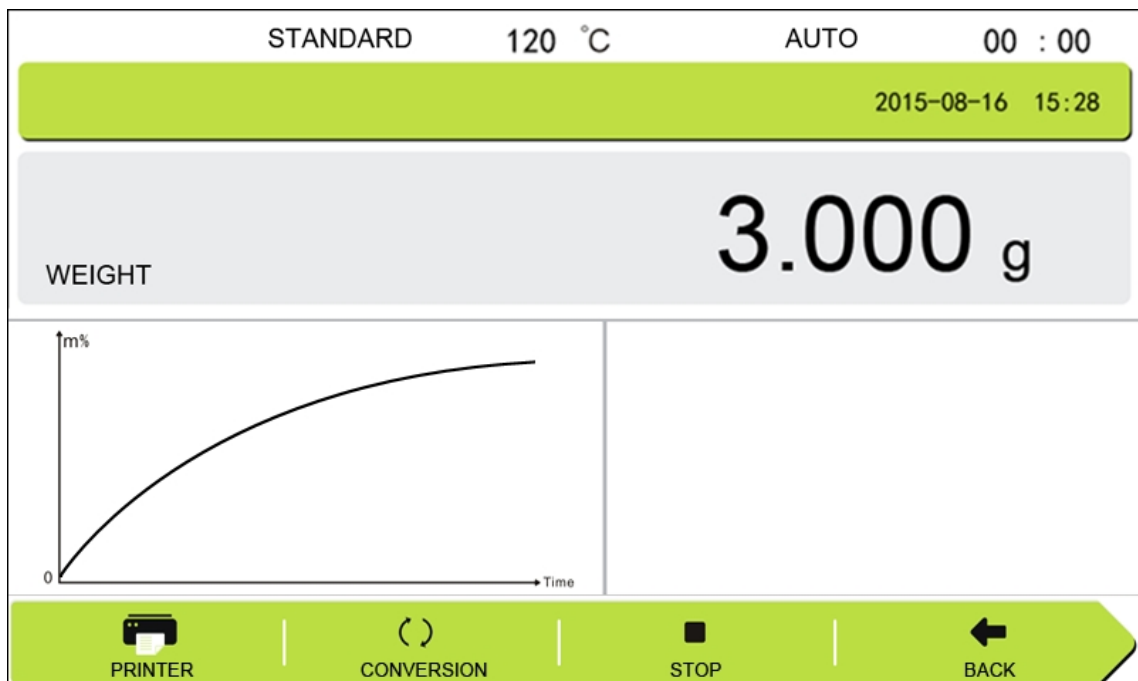

#### 3.2 Test Page:

Print: Print the history of the testing;

Conversion: Choose the result display for :Moisture/Sample weight/dry%;

Stop: Stop the testing; Back: Back to start page.

Curve: Vertical axis: moisture content,

Horizontal axis: time:

## Fourth:Home Page



This page for choose the different function and setting as required.

### 4.1 Parameters Setting

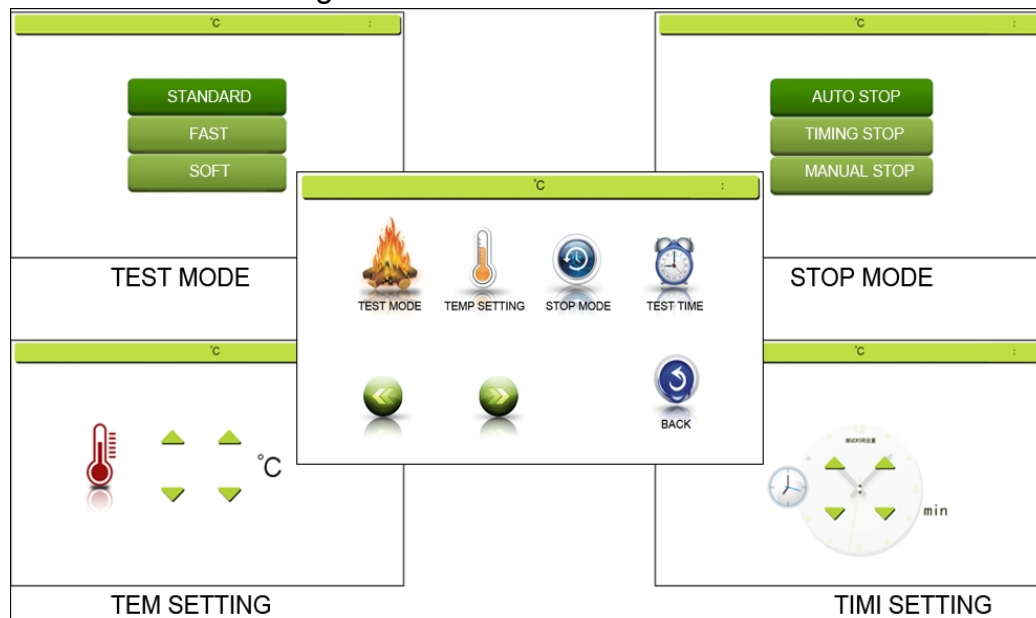

#### Stop Mode:

Auto Stop: The testing will stop when it differentiate the moisture testing finish.

Timing Stop: You can setting the testing time as your required.

Manual Stop: The testing will not stop until you press the stop key.

#### Testing Mode:

Auto Mode: The mode suit for most sample for common moisture test;

Soft Mode: Some fusible and volatility things can choose this mode;

Fast Mode: Some stable and the more stability things can choose this mode.

#### Temperature Setting:

You can choose the temperature as you need.

Temperature range: 40~230°C

Temperature step: 1°C

#### Timing Setting:

The mode just suit for the timing stop mode. This function can simulate the oven experiment

## 4.2 History

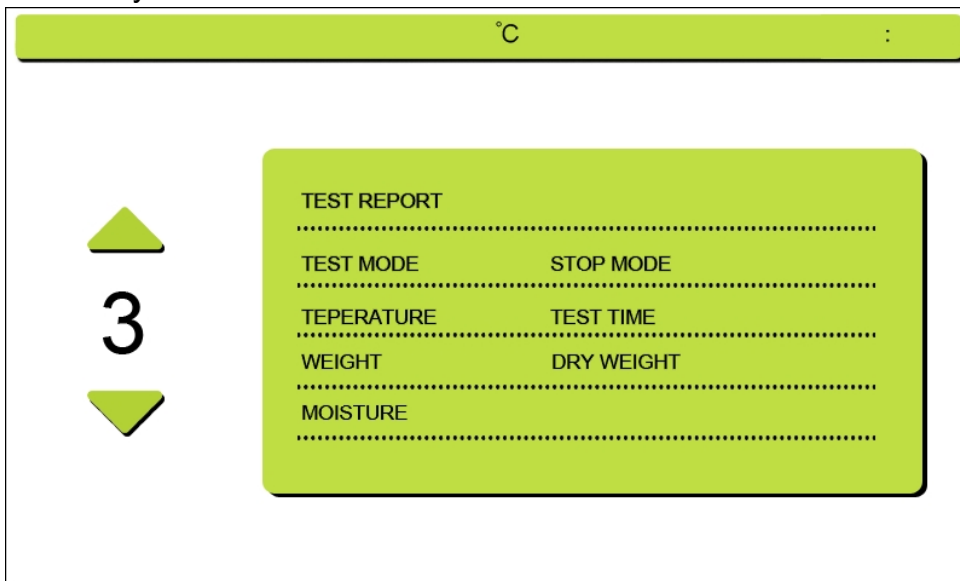

Operator can choose the history and print the result.

The information include:

- 1.Model;
- 2Test mode.;
- 3.Stop mode;
- 4.Test Temperature;
- 5.Test Time;
- 6.Wet Weight;
- 7.Dry Weight;
- 8.Moisture Content.

## 4.3 Printer

4.3.1: The baud rate and communication mode.

Baud rate: 1200/2400/4800/9600

4.3.2: Communication mode: Continuous/Point output

## 4.4 Calibration



When the instrument error or improper operate . Calibration weights can be adjusted with accuracy. Press "One point calibration" and does not release until it display "-cal-",Then flashing put on the "200.000", put on the calibration weight, then it will display "= = = = =", until it display "200.000",and will show Remove the weight, it will display "= = = = =" again, Waiting it show " 0.000", the calibration is completed.

When the instrument can not work,you can also choose the multi-point calibration, and according the note,operation the calibration..



#### 4.5 LANGUAGE

Enter the language page and choose the language as required.



#### 4.6 SYSTEM SETTING

This menu include:

1. DATA BASE;
2. DATE/TIME ;
- 3.HUMITY CALIBRATION
4. TOUCH CALIBRATION;
5. FACTORY SETTING

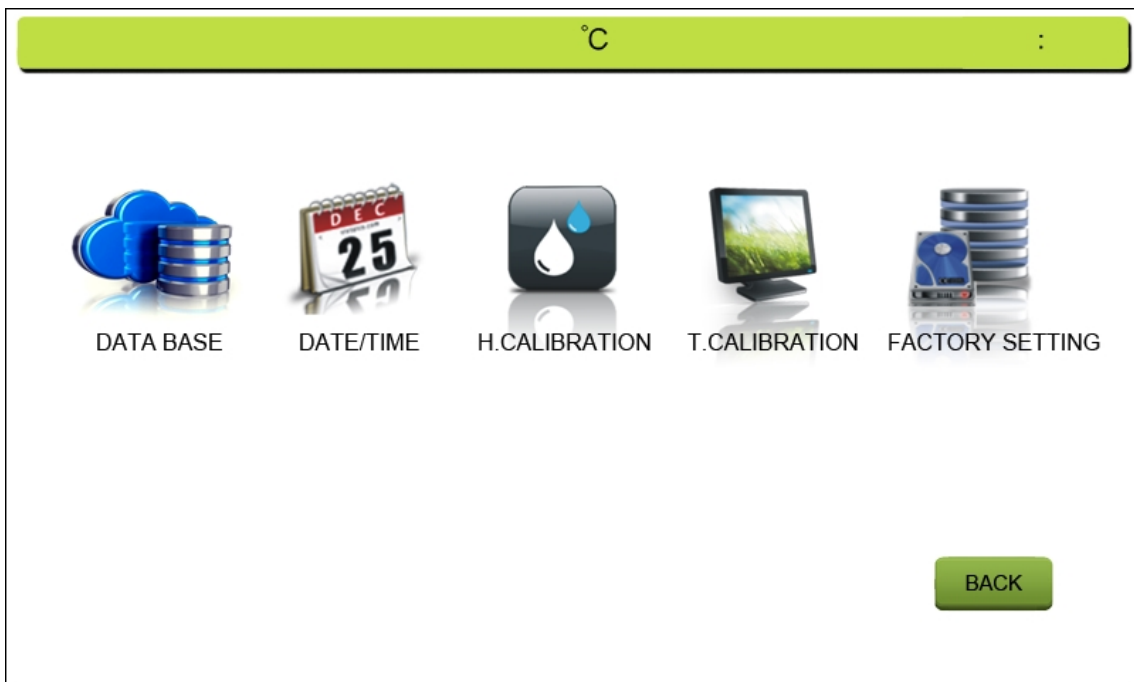

#### 4.6.1 DATA BASE:

°C :

|                                                                                                                                                                                                  |                                                                                                                                                                                                             |                                                                                                                                                                                                               |                                                                                                                            |                                                                                                                                                                                                           |                                                                                                                                                                                                                |
|--------------------------------------------------------------------------------------------------------------------------------------------------------------------------------------------------|-------------------------------------------------------------------------------------------------------------------------------------------------------------------------------------------------------------|---------------------------------------------------------------------------------------------------------------------------------------------------------------------------------------------------------------|----------------------------------------------------------------------------------------------------------------------------|-----------------------------------------------------------------------------------------------------------------------------------------------------------------------------------------------------------|----------------------------------------------------------------------------------------------------------------------------------------------------------------------------------------------------------------|
| <p><b>CORN:</b></p> <p>The different structure will effect the result of moisture content. So we need choose the different setting for them.</p>                                                 | <input type="button" value="Corn 01"/> <input type="button" value="Corn 02"/> <input type="button" value="Corn 03"/> <input type="button" value="Corn 04"/> <input type="button" value="Corn 05"/>          | <input type="button" value="Corn 06"/> <input type="button" value="Corn 07"/> <input type="button" value="Corn 08"/> <input type="button" value="Corn 09"/> <input type="button" value="Corn 10"/>            | <p><b>WHEAT:</b></p> <p>There are so many kinds of wheats, so we need choose the suitable kinds of setting for testing</p> | <input type="button" value="Wheat 21"/> <input type="button" value="Wheat 22"/> <input type="button" value="Flour 23"/> <input type="button" value="Flour 24"/> <input type="button" value="Noodles 25"/> | <input type="button" value="Buckwheat21"/> <input type="button" value="Oat 27"/> <input type="button" value="Barley 28"/> <input type="button" value="Quinoa 29"/> <input type="button" value="WheatFlour30"/> |
| <p><b>RICE:</b></p> <p>The rice moisture content test need according to it including the shell or not.<br/> R-RICE W:WET<br/> PRG-R: Polished round-grained rice<br/> LS-R: long-shaped rice</p> | <input type="button" value="Rice 11"/> <input type="button" value="Rice 12"/> <input type="button" value="Paddy 13"/> <input type="button" value="Paddy(W) 14"/> <input type="button" value="Paddy(W) 15"/> | <input type="button" value="Brow-R 16"/> <input type="button" value="PRG-R 17"/> <input type="button" value="LS-R 18"/> <input type="button" value="Sticky-R 19"/> <input type="button" value="Powder-R 20"/> | <p><b>OTHERS:</b></p>                                                                                                      | <input type="button" value="Soybean 31"/> <input type="button" value="Mungbean 32"/> <input type="button" value="Peanut 33"/>                                                                             | <input type="button" value="Cornstarch34"/> <input type="button" value="Lotusroot 35"/> <input type="button" value="Tapioca 36"/>                                                                              |

The data base store many kinds of setting for different sample,operator can Choose the suitable setting for required. If you can not find the suitable setting, Please set it by you self according in 4.1

#### 4.6.2 DATE/TIME

°C :

DATE/TIME SETTING

DATE

▲ ▼
▲ ▼
▲ ▼

TIME

▲ ▼
▲ ▼
▲ ▼

Operator can set the time and date in this page, and the setting will showing in the test page and will print in the test report.

#### 4.6.3 H.CALIBRATION:

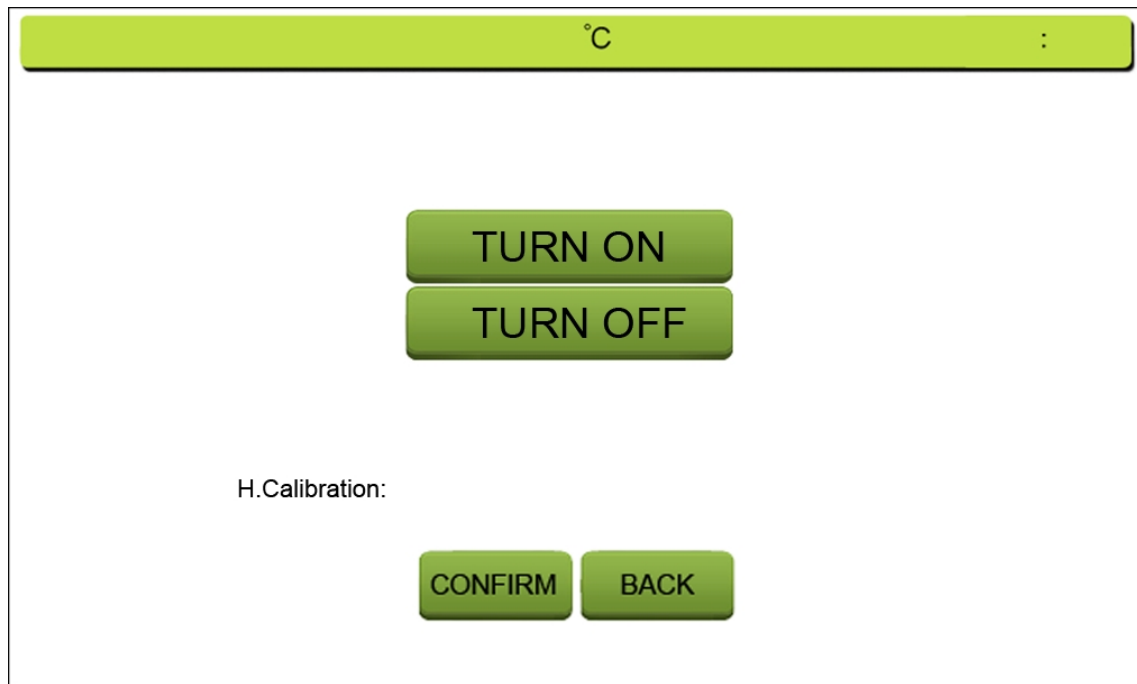

The humidity changed in our environment will effect our moisture test, especially when we test the micro moisture content, it will impact effect the result. So we need turn on this function to keep the result more accuracy.

The operation as blow:

1.Enter the H.calibration page;

2.Press turn on and then press confirm;

3.Back to the testing page,move away the sample pan;Press: Tare, then it will show:0.000g; Put on the pan, and close the cover; Press" Start" and the window will show the H.Calibration, it mean environment calibration working. Then Testing finish, put on the sample and test continue.

4.The test need do it before the real sample test, and H.Calibration result will store in the H.Calibration page ;

5.Because of the environment are always change, the this value not all the same, so the alue of the H.Calibration will disappear when power off.

## H.Calibration

#### 4.6.4 TOUCH CALIBRATION:

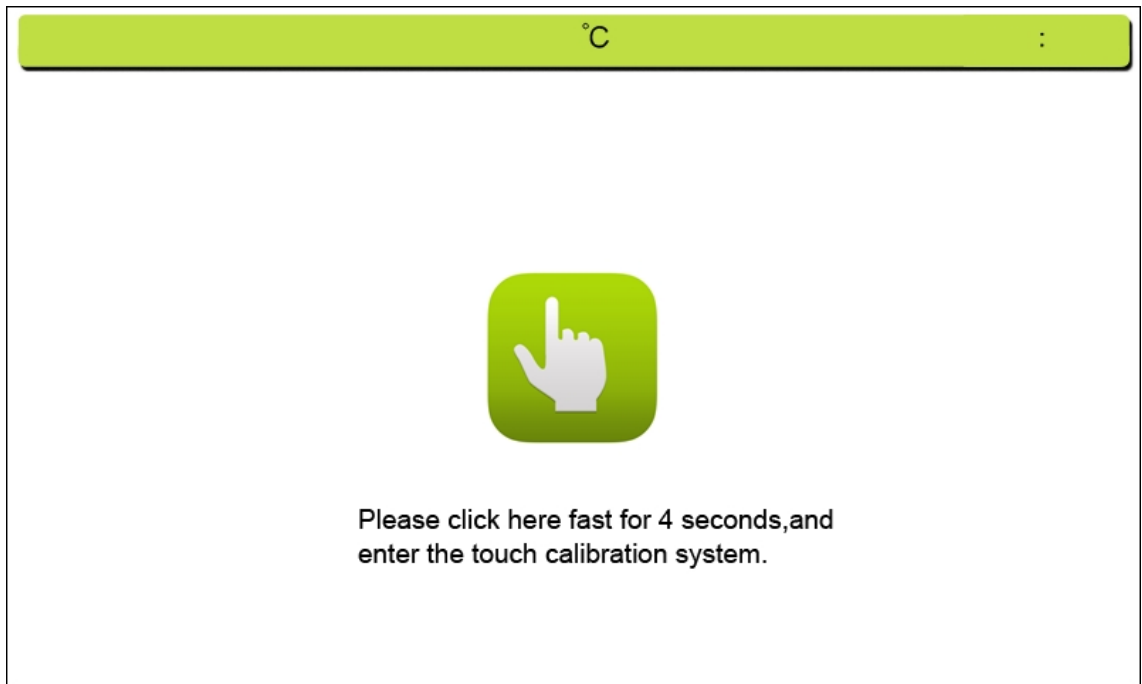

When the touch system have error or mistake, we can use this function to Calibration the touch panel.the operation please according the promotion which showing in the display.

#### 4.6.5 FACTORY SETTING:

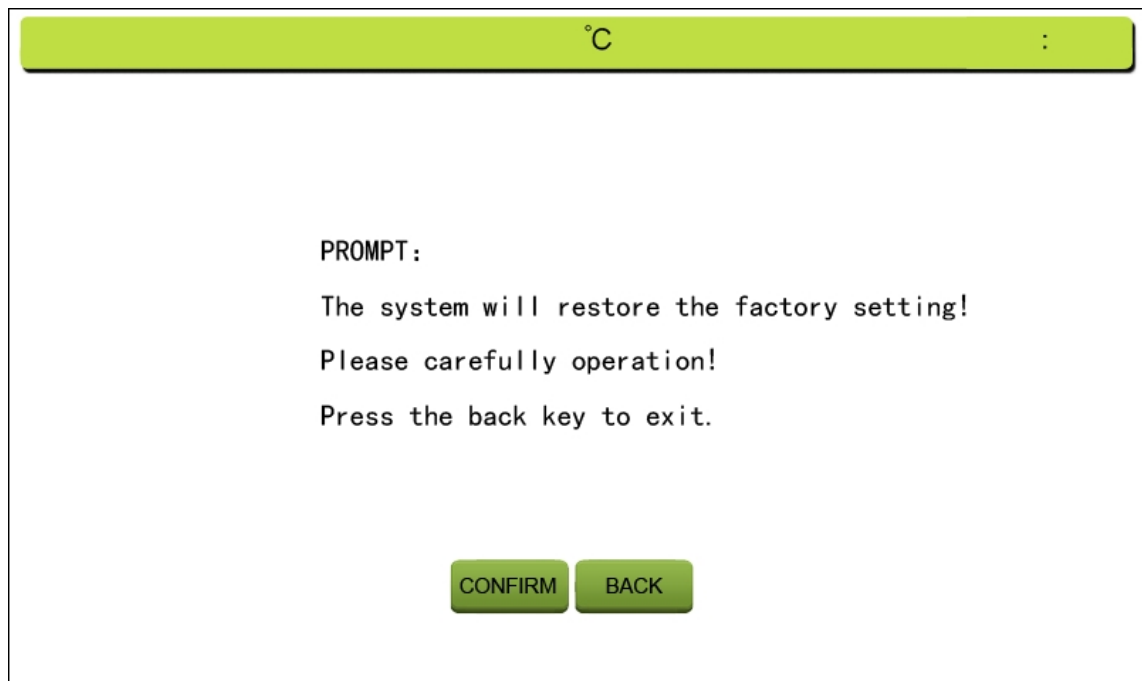

When the setting have error , we can use this function to back to the factory setting ,But it will make all test report disappear. So please use it carefully

#### 4.7 SYSTEM INFORMATION

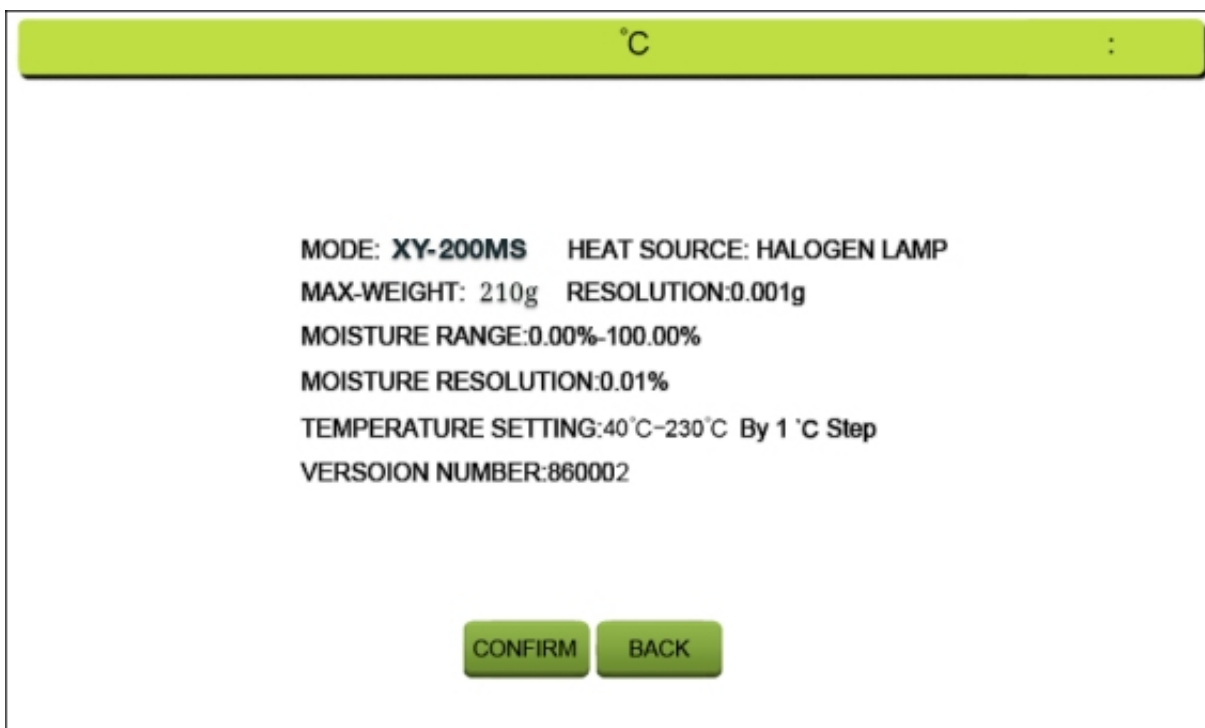

| MODEL             | XY-100MS           | XY-100MS<br>(plus) | XY-200MS | XY-200MS<br>(plus) |
|-------------------|--------------------|--------------------|----------|--------------------|
| SPECIFICATIO<br>N |                    | 110g               |          | 210g               |
| RESOLUTION        | 1mg                |                    |          |                    |
| M.RESOLUTION      | 0.01%              |                    |          |                    |
| M.RANGE           | 0.00%-100.00%      |                    |          |                    |
| PAN SIZE          | Φ 100              |                    |          |                    |
| HEATER            | Halogen lamp       |                    |          |                    |
| INDICATOR         | 7 inch touch panel |                    |          |                    |
| TEM.SETTING       | 40°C~230°C         |                    |          |                    |
| TIME.SETTING      | 1~99min            |                    |          |                    |
| HEATING<br>HIGHT  | 35mm               |                    |          |                    |
| ATRO              | 100%~999%          |                    |          |                    |
| ATRO              | 0%~999%            |                    |          |                    |
| STORAGE           | 20 Group           |                    |          |                    |
| COMMUNITION       | CABLE              |                    |          |                    |
| BATTERY           | NO                 |                    |          |                    |

## Fifth: Schedule: assembly drawing

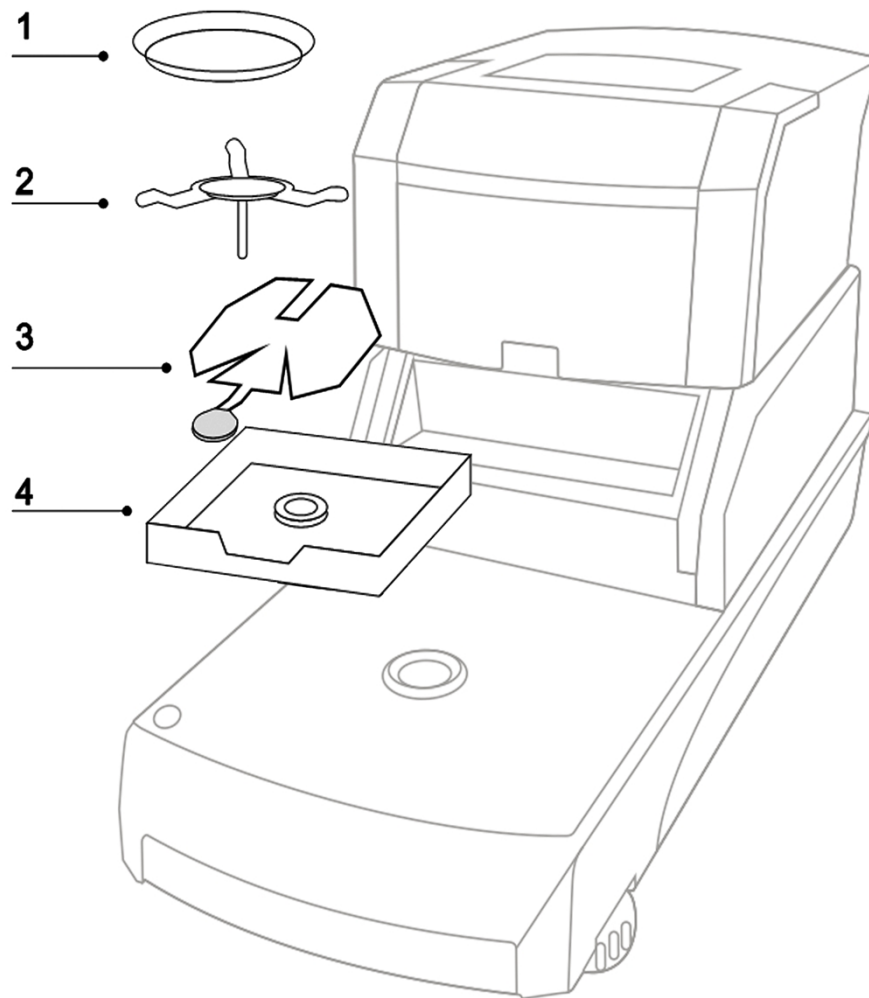

Please installation the instrument according the picture

Installation order from top to bottom :1 --2--3--4--5

1. Aluminum scale pan
2. The triangle scale frame
3. Scale pan brackets
4. Wind cover

Note: Please confirm put the No 4 part the point on the true place.

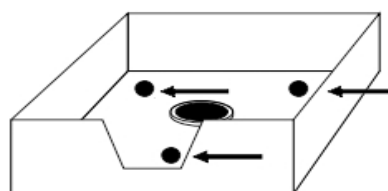

## Sixth:Automatic Open.

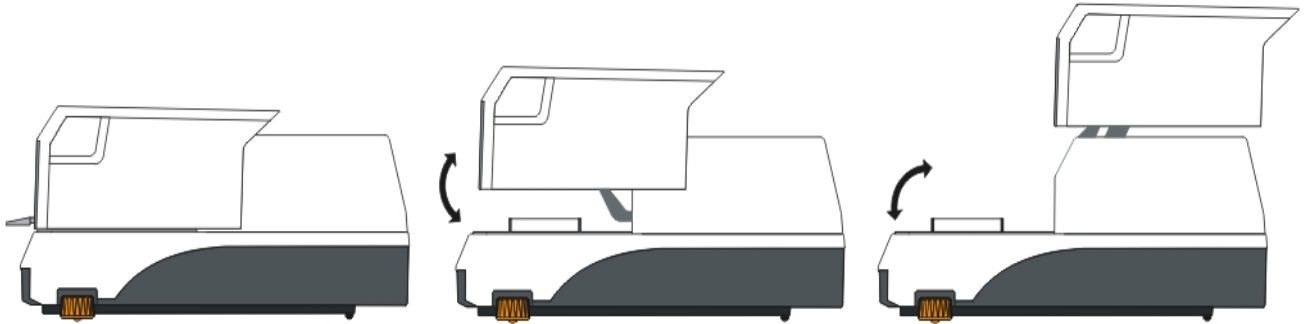

### 6.1 Function Introduce

The moisture analyze use dual motor for automatic open the chamber, it reduce the gear drive, so avoid mechanical vibration. Keeping the weighing system more stable and quiet. We can press  to open or close the chamber

### 6.2 Intelligent Sensing

We add the intelligent sensor in this system, it means when anything keep or forget On the pan and the chamber close, the cover will feel the obstruction and back to The opening state. It can avoid the chamber crush the hand and body.

### 6.3 Notes:

- 1.Please use the automatic with operator supervision.
- 2.Do not open or close the chamber by manual, it will broken the automatic system, If make it error, please press"open/close" key and restart the chamber 2times, The system will find the true point.
- 3.Please do not open the machine and repair by yourself, if anything make it not working, please contact us.
- 4.Please close the chamber then power off or left.

### **Seventh: Tips:**

1. Please warm-up the analyzer 30 minutes and take the first time calibration;
2. Please do the warm up testing after calibration experiments (see 3.6);
3. Each time the switch machine, please interval of 5 seconds;
4. Cover the heater, do not leave the weight on the pan, or halogen lamps will be crushed, please use the calibration weight which we put in the machine.
5. Please turn off the power when you leave.
6. Please do not testing unmanned monitoring

### **Eight: Options**

Temperature calibration instrument: It is used for the moisture analyzer temperature calibration.



POS printer: optional with RS232 connection, for printing test report.





## Ninth:Schedule: Problems and troubleshooting

| No | APPERANCE                           | REASONS                                                                                     | SOLUTION                                                                                                      |
|----|-------------------------------------|---------------------------------------------------------------------------------------------|---------------------------------------------------------------------------------------------------------------|
| 1  | Note:the chamber is open.           | The chamber not close                                                                       | Close the chamber then test.                                                                                  |
| 2  | Note:the sample less than 1g        | The test sample too light                                                                   | Please put on the weight more than 1g                                                                         |
| 3  | Note: the chamber open error!       | Open the chamber by manual or something hinder the chamber close                            | Please try again close and open the chamber until the tips disappear.                                         |
| 4  | It can not weighing or not accuracy | Power problem or sensor problem                                                             | 1.Please restart the machine(Turn off the power and waiting 5 seconds then turn on)<br>2.Try to calibration . |
| 5  | Can not heating                     | 1.Lamp broken<br>2.Temperature setting too lower<br>3.Main-board problem                    | 1.Change new lamp<br>2.Reset the test temperature<br>3.Factory repair                                         |
| 6  | Not stop heating                    | 1.Change stop mode<br>2.Temp sensor broken<br>3.Temp protect broken                         | 1.Change to auto stop.<br>2.Change a new temp sensor<br>3.Change a new                                        |
| 7  | Instrument display data error       | 1.The indicator sudden power off.<br>2.The indicator was broken<br>3.The machine was broken | 1.Power off and power on again the indicator<br>2.Factory repair.                                             |

Note: Please do not open and repair machine when come across the problem .

## **Tenth:After sales and warranty**

1. This product is guaranteed for one year.
  2. In the warranty period, according to the use of instructions for the normal use of the condition of the failure (by the company official staff judge), to be free of repair.
  3. During the warranty period, if any one of the following circumstances, must be used as a charge repair:
    - 1)Can not provide the guarantee and effective proof of purchase。
    - 2)The machine damaged because of uncommon use.
    - 3)The machine damaged because of shipping or delivery.
    - 4)Other unavoidable external factors cause failure and damage.
    - 5)Damage caused by improper use of water or other solution.
    - 6)Damage caused by the use of other power supply .
  4. This option or parts not in the warranty ( halogen lamp、weighing sensor.sample pan ) .
  5. We are not responsible for the accident which cause by the machine.
-

