

**Features**

- High efficiency up to 96%
- THD <15%
- Output current adjustable via potentiometer
- Dim to off
- 3 versions selectable: 3-in-1 dimming, non-dimmable & 3-in-1 dimming + 12V AUX output
- All-round protections: open circuit protection / short circuit protection
- Surge protection: L-N: 6kV & L/N-GND: 6kV
- Flicker free
- IP54



**Applications**

· Shoebox light · highbay light · flood light · wall light

**Descriptions**

LF-FAx320 is a constant current LED driver featuring high efficiency, high PF and low THD. It has 3 selectable versions: 3-in-1 dimming, non-dimmable and 3-in-1 dimming + 12V AUX output. There is a potentiometer on the top of LED driver that is used to adjust the output current (power). Besides, it complies with the latest European ErP standard and North American DLC standard.

**Product Model**

LF - FA A / B / C 320

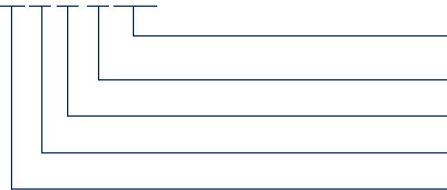

- 320: rated output power: 320W
- C: 3-in-1 dimming
- B: non-dimmable
- A: 3-in-1 dimming + 12V (light sensor optional)
- F: non-isolated design; A: serial number

**Lifud Technology Co., Ltd.**

Production Base I (HQ): Building B, Kutto Industrial Park, NO.26 Xinhe Road, Bao'an District, Shenzhen, China.  
 Production Base II: No.4, Block 2, Tengfei Road, Shigao Economic Development Zone, Tianfu New Area, Sichuan, China.  
 Website: www.lifud.com Telephone: +86(0)755 8373 9299 Email: sales@lifud.com

## ■ Electrical Characteristics

Model		LF-FAA320	LF-FAB320	LF-FAC320
Output	Output Current	Adjustable via potentiometer		
		1100-1500mA		
	Default Current	1330mA $\pm$ 5%		
	Output Current	Adjustable via DIP switch (optional)		
		70%-100% @maximum output current (set by user and for FAA/FAC version only)		
	Flicker	Complies with IEEE Std 1789		
	Output Voltage	180-260Vdc (LED)		
	Output Power	320W max.		
	Start-up Time	120Vac < 1S @full load; 230Vac < 0.5S @full load		
	Linear Adjustment Rate	$\pm$ 5% @full load		
	Load Adjustment Rate	$\pm$ 8% @full load		
Temperature Drift	$\pm$ 3% @Tc 25-75°C			
Input	Input Voltage	100-277Vac (voltage limit: 90-305Vac)		
	DC Input Voltage	141-276Vdc		
	Input Frequency	0/50/60Hz		
	Input Current	4A max.		
	PF	$\geq$ 0.98/120Vac @full load; $\geq$ 0.95/230Vac @full load		
	THD	$\leq$ 15% @full load		
	Efficiency	$\geq$ 92.5%/120Vac @240Vdc/1330mA; $\geq$ 94.5%/230Vac @240Vdc/1330mA		
	In-rush Current	< 100A/350uS @230Vac		
	Standby Power Consumption	$\leq$ 0.5W @220Vac		
12V AUX Output (for FAA only)	Output Voltage	+12Vdc (11-14V)		
	Output Current	200mA max.		
	Dynamic Load	Please make sure that it matches the LED driver.		
	Ripple Voltage	$\leq$ 1V		
Protections	Surge	L-N: 6kV (2 $\Omega$ ), L/N-PE: 6kV (12 $\Omega$ )		
	Open Circuit	Open-circuit voltage $\leq$ 310Vdc		
	Short Circuit	$\leq$ 15W The LED driver will recover by itself and will not be damaged even in the state of short circuit for a long time.		
	Grounding Resistance	$\leq$ 0.1 $\Omega$ @25A/60S		
	Insulation Resistance	$\geq$ 10M $\Omega$ @I/P-PE O/P-PE: 500Vdc/60S/25°C/70%RH		

### ■ Electrical Characteristics

<b>Environment Descriptions</b>	Casing Temperature	-40°C~+90°C
	Operating Humidity	0~95%RH (no condensation)
	Storage Temperature/ Humidity	-40°C~+80°C (6 months in Class I environment); 0~95%RH (no condensation)
	Atmospheric Pressure	86~106kPa
<b>Safety and EMC</b>	Certifications	TUV-ENEC, CE, CB, RCM, SAA, FCC, UL
	Withstanding Voltage	L-N/PE: 1.5KVac, <5mA, 60S; L-N/DIM: 3KVac, <5mA, 60S; DIM/PE: 500Vac, <5mA, 60S
	Safety Standards	ENEC: EN61347-1: 2015, EN61347-2-13: 2014/A1: 2017, EN62384: 2016/A1 2009 CE-LVD: EN 61347-2-13: 2014/A1: 2017, EN 61347-1: 2015, EN 62493: 2015 CB: IEC 61347-1: 2015, IEC61347-2-3: 2014, IEC 61347-2-13: 2014/AMD1: 2016 SAA: AS 61347.2-13: 2018 RCM: AS 61347.2-13: 2018 UL: UL8750, CSA 250.13
	EMI	CE-EMC/RCM: EN55015, EN61000-3-2, EN61000-3-3 FCC: PART 15 CLASS B @120Vac FCC: PART 15 CLASS A @277Vac
	EMS	CE-EMC/RCM: EN61000-4-2, 3, 4, 5, 6, 11 Complies with IEC61000-4-2, 3, 4, 5, 6, 8, 11, 12; IEC61547
	Ringing Wave	4kV
	ESD	Air 8kV, touch 4kV
<b>Other Parameters</b>	IP Rating	IP54
	RoHS	RoHS 2.0 (EU) 2015/863
	Warranty	5 years (Tc ≤80°C)
	MTBF	>1000Khours@Telcordia SR-332 Issue4
<b>Testing Equipment</b>	AC power source: CHROMA6530, digital power meter: CHROMA66202, oscilloscope: Tektronix DPO3014, DC electronic load: M9712B, LED board, constant temperature and humidity chamber; Everfine EMS61000-5B: Everfine EMS61000-4A, spectroanalyzer: KH3935, hi-pot tester: EEC SE7440, flicker tester (flicker-free coefficient test): LFA-3000, etc.	

### ■ Electrical Characteristics

<b>Testing Remark</b>	If there are no special remarks, the above parameters are tested at the ambient temperature of 25°C, humidity of 50%, full load and input voltage of 230Vac.
<b>Additional Remarks</b>	<ol style="list-style-type: none"> <li>1. It is recommended that user install over voltage protection, under voltage protection and surge protection devices in the power supply circuits of light fixtures to ensure electricity safety.</li> <li>2. The PC cover, casing and end cap for assembling the LED driver in the light fixture must meet the fire rating of UL94-V0 or above.</li> <li>3. The LED driver used in combination with the end device is one of the accessories of the whole light fixture, and the EMC of the whole light fixture is not only susceptible to the driver itself, but to the LED light fixture and the whole light fixture's wiring. Thus, the manufacturer of LED light fixture should re-confirm the EMC of the whole light fixture before the whole light fixture is finished.</li> <li>4. It is suggested that user use a slotted screwdriver or a Philips to adjust the output current of LED driver in case that the potentiometer is damaged (the screwdriver should have good insulation at the head, body and handle, and the screwdriver with a 2mm head is recommended as well; what's more, please pay attention that the intensity of torque not exceed 500g.cm).</li> <li>5. When using the LED driver, please pay attention that the total output power not exceed the maximum rated output power, otherwise the warranty service of LED driver would be failed.</li> <li>6. When conducting withstanding voltage test on LED driver, please short-circuit the input wire L and N; the positive electrode and negative electrode of the output wire; the positive electrode and negative electrode of the dimming wire and AUX power supply.</li> <li>7. Please fully inspect the withstanding voltage ability of LEDs and aluminum substrates and the value shall be &gt;2.5kVac.</li> <li>8. Lifud reserves the right to interpret any of the above parameters.</li> </ol>

### ■ Qty & Parameters of Driver (the same model) a Circuit Breaker Configures

Term	Peak Inrush Current (Ipeak)	Half-peak Inrush Current (Twidth)
Input voltage 120Vac	38.6A	72uS
Input voltage 230Vac	83A	476uS

■ Qty & Parameters of Driver (the same model) a Circuit Breaker Configures

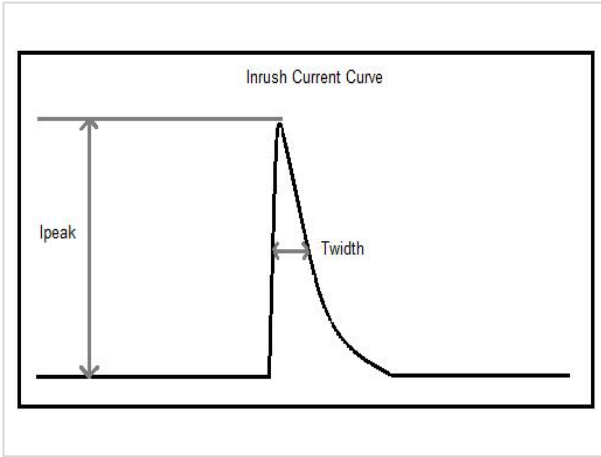

Qty of Driver a Circuit Breaker Configures (input voltage: 230Vac)		
Type	Rating	Qty of Driver
B	10A	2 pcs
	13A	2 pcs
	16A	3 pcs
	20A	4 pcs
	25A	5 pcs
C	10A	3 pcs
	13A	4 pcs
	16A	5 pcs
	20A	6 pcs
	25A	8 pcs

■ Product Characteristic Curves

PF Curve

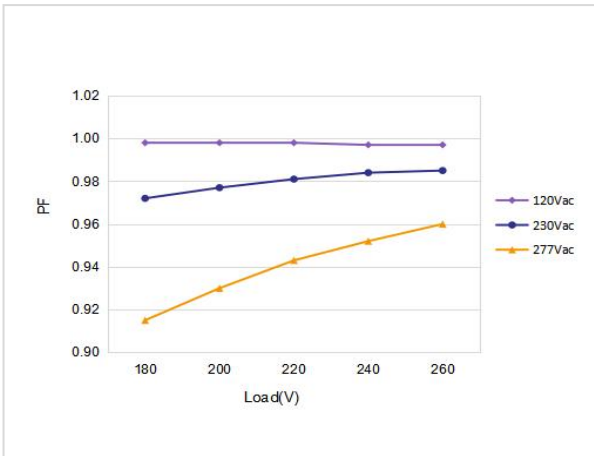

Efficiency Curve

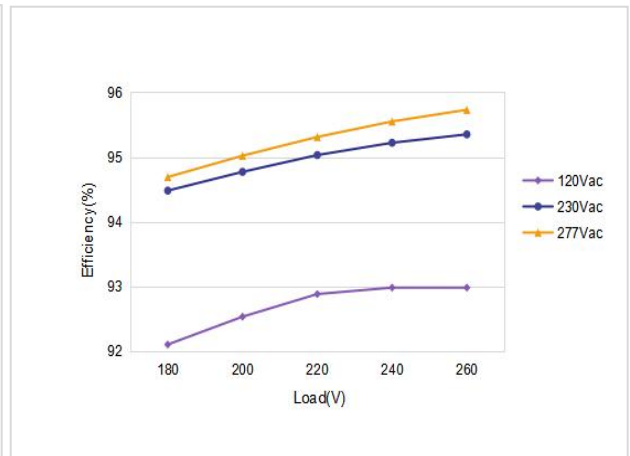

■ **Product Characteristic Curves**

Load Derating Curve

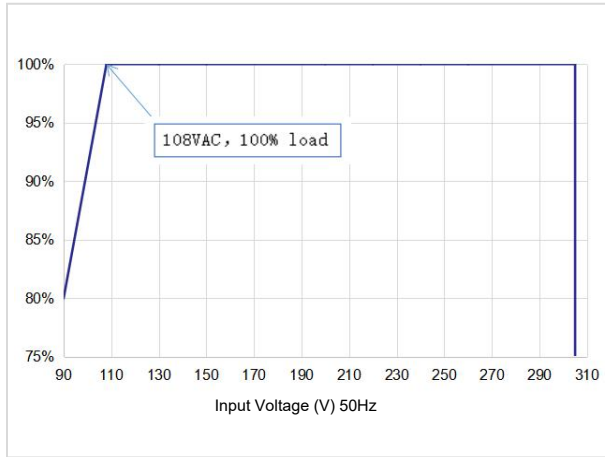

Power Curve

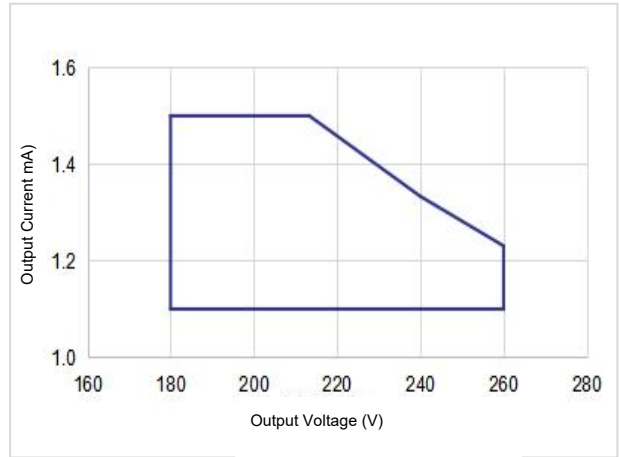

Lifetime Curve

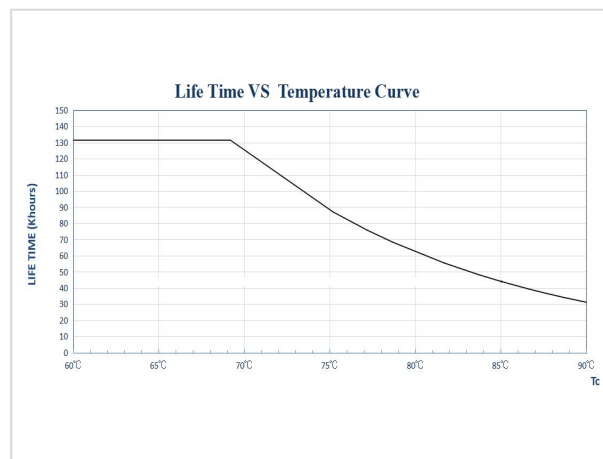

■ **Dimming Operation Instructions**

Output current adjustable via built-in potentiometer

Parameter	MIN	TYP	MAX	Note
Output Current	1100mA	1330mA	1500mA	The total output power should <b>NOT</b> exceed 320W

The initial current of FAA or FAC version (DIP switch version) is adjustable via the potentiometer; the blue wire is connected to DIP switch module (the adjustable current via the DIP switch is susceptible to the one via the potentiometer). Besides, the DIP switch resistance (adjustable resistance via the DIP switch) ranges from 110Ω to 300KΩ. Therefore, when user set the output current of LED driver, the adjustment is supposed to range from 70% to 100% of the maximum current so as to meet certifications' standards.

■ **Dimming Operation Instructions**

Curve of DIP Switch Resistance and Output Current

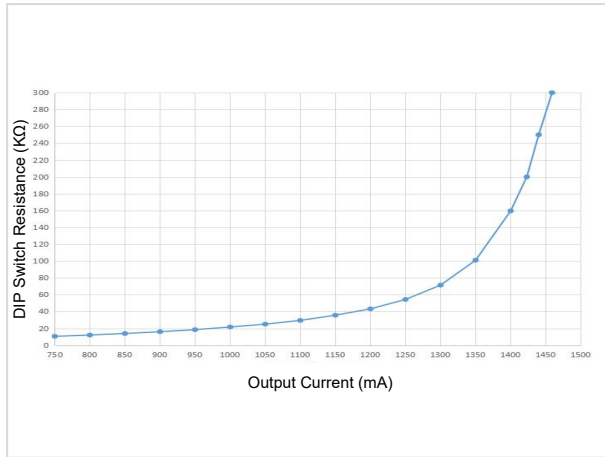

0-10V Dimming Operation

- Connect 0-10V signal to DIM terminal.
- In 0-10V dimming mode, when the input voltage is  $0.8V \pm 0.15$ , the light turns off; when it's  $1.0V \pm 0.15$ , the light turns on.
- Dimming depth: 10% (typical value), the maximum is <12%
- DIM+/- (without signal connected): 100% rated current output

Wiring Diagram of 0-10V Dimming

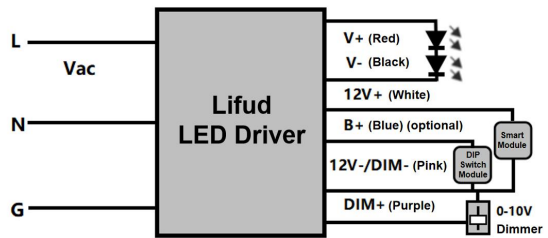

This diagram is only for FAA version; FAC version has no 12V+; FAB version has no 12V+/DIM+, 12V-/DIM- or B.

■ Dimming Operation Instructions

Dimming Curve

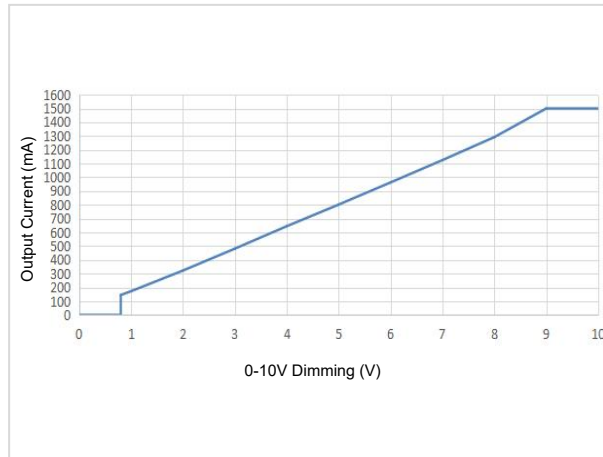

Input: 230Vac; output: 213Vdc/1500mA  
 (this data is measured by Lifud 0-10V dimmer and the chart is for reference only)

PWM Dimming Operation

- Connect PWM signal to DIM terminal.
- Dimming depth: 10% (typical value), the maximum is <12%
- Compatible signal range: 1000-3000(Hz), amplitude: 9-10(V)
- DIM+/- (without signal connected): 100% rated current

Wiring Diagram of PWM Dimming

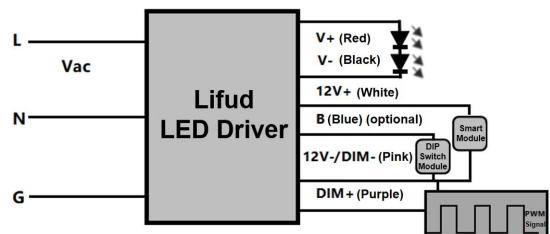

This diagram is only for FAA version; FAC version has no 12V+; FAB version has no 12V+/DIM+, 12V-/DIM- or B.



■ Dimming Operation Instructions

Dimming Curve

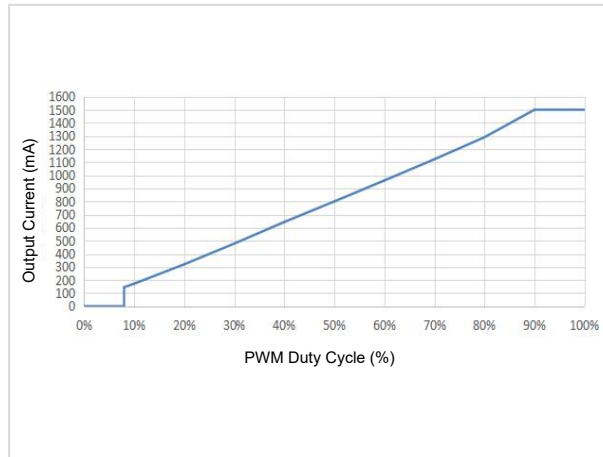

Input: 230Vac; output: 213Vdc/1500mA

(this data is measured by Lifud PWM signal generator RIGOL and the chart is for reference only)

Rx Dimming Operation

- Connect Rx signal to DIM terminal.
- Range: 0-100KΩ
- Dimming depth: 10% (typical value), the maximum is <12%
- DIM+/- (without signal connected): 100% rated current

Wiring Diagram of Rx Dimming

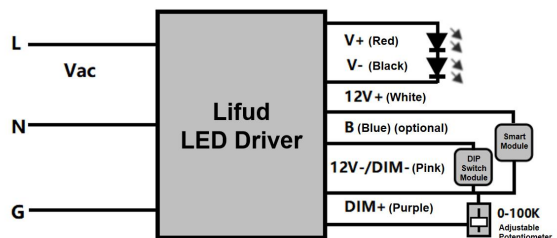

This diagram is only for FAA version; FAC version has no 12V+; FAB version has no 12V+/DIM+, 12V-/DIM- or B.

■ **Dimming Operation Instructions**

Dimming Curve



Input: 230Vac; output: 213Vdc/1500mA  
 (this data is measured by resistance dimmer and the chart is for reference only)

Dim-to-off “Without Afterglow” Operation

When the dimming signal is 0V, the LED driver has no output, but there exists junction capacitance between the aluminum substrate’s copper foil and the grounding wire, which will make the LEDs glow slightly. Thus, it is necessary to respectively attach a resistor to every node of LED beads in parallel, and the resistance should match for the parameters of aluminum substrate and LEDs. (reference resistance: 3-5KΩ/size: 1206)

**The parallel connection is shown on the right:**

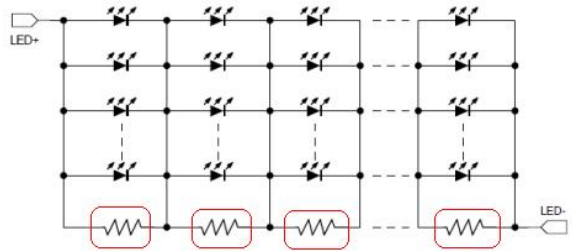

■ **Structure & Dimensions (unit: mm; tolerance: ±2mm)**

Wire Specifications

Type	Input Wire	Output Wire	Dimming Wire & AUX Output Wire
FAA	PVC Electronic Wire UL1015 18AWG $\Phi 2.8 \pm 0.5$	PVC Electronic Wire UL1015 18AWG $\Phi 2.8 \pm 0.5$	PVC Electronic Wire UL1015 22AWG $\Phi 2.3 \pm 0.5$
FAB	PVC Electronic Wire UL1015 18AWG $\Phi 2.8 \pm 0.5$	PVC Electronic Wire UL1015 18AWG $\Phi 2.8 \pm 0.5$	/
FAC	PVC Electronic Wire UL1015 18AWG $\Phi 2.8 \pm 0.5$	PVC Electronic Wire UL1015 18AWG $\Phi 2.8 \pm 0.5$	PVC Electronic Wire UL1015 22AWG $\Phi 2.3 \pm 0.5$
Color	AC-L Black; AC-N White; PG Green	LED+ Red; LED- Black	DIM+ Purple; DIM- Pink; 12V+ White; B Blue (optional)
Length	250±20mm (L1)	300±20mm (L3)	220±20mm (L2)
Tinned	10±1.5mm (Y1)	10±1.5mm (Y3)	10±1.5mm (Y2)

Casing Dimensions

Description	Symbol	Unit (mm)
Length	L	224
Width	W	48
Height	H	34

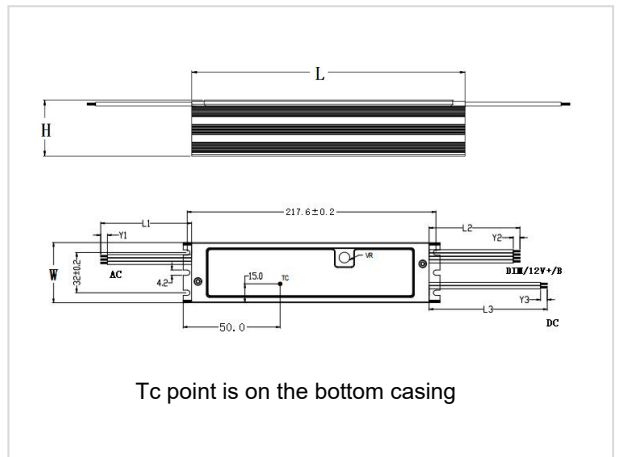

■ **Heat Dissipation Instruction**

It is well-advised to apply the thermally conductive silicone grease between the radiator on the light fixture and LED driver so as to ensure that the thermally conductive silicone grease is in close contact with the light fixture. Moreover, the casing temperature (Tc) shall not exceed +90°C.

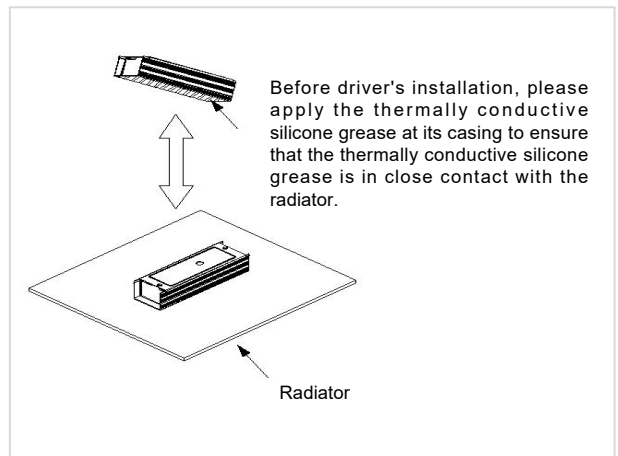

■ **Packaging Specifications**

Model	LF-FAA/FAB/FAC320
Carton Size	420*305*225mm (L*W*H)
Quantity	7 pcs/layer; 3 layers/ctn; 21 pcs/ctn
Weight	0.650±0.1 kg/pc; 14.9±1.2 kg/ctn

■ **Transportation and Storage**

**1. Transportation**

- Suitable transportation means: vehicles, boats and aeroplanes.
- In transit, it is necessary to prepare awnings for rain or sun protection. Moreover, please keep civilized loading and unloading to prevent the vibration or impact of LED driver as much as possible.

**2. Storage**

- The storage of LED driver shall conform to the standard of Class I environment. When using LED drivers which have been stored for more than 6 months, please re-test them firstly. Do not use them unless they are tested to be qualified.

**Cautions**

- Please use Lifud LED driver according to its parameters in the specification, otherwise the LED driver may malfunction.
- Using any incompatible light fixtures or those that have not been certified may cause fire, explosion or other risks.
- Man-made damage is beyond the scope of Lifud warranty service.

Remark: Lifud Tecnology Co., Ltd. reserves the right to interpret any contents of this specification.